



OSG  **PHOENIX**®

カタログ 2022

Catalog 2022

オーエスジー

穴加工

Drilling

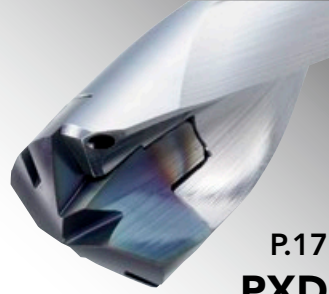

P.17

PXD

ヘッド交換式ドリル 3D/5D
Exchangeable Head Drill 3D/5D



P.33

PD

インデキサブルドリル 2D/3D/4D/5D
Indexable Drill 2D/3D/4D/5D



P.53

PHP

インデキサブルドリル 3D
Indexable Drill 3D



P.59

PDZ

NEW インデキサブルフラットドリル 2D/3D
Indexable Flat Drill 2D/3D



P.71

PZAG

座ぐりカッタ
Counterboring Cutter



P.77

PLDS

NEW インデキサブルリーディングドリル
Centering and Chamfering Cutter



P.125

PSEL

ラフィングエンドミル
Roughing End Mill



P.135

PSTW

New Size

6コーナ肩削りカッタ
6-Corner Shoulder Cutter

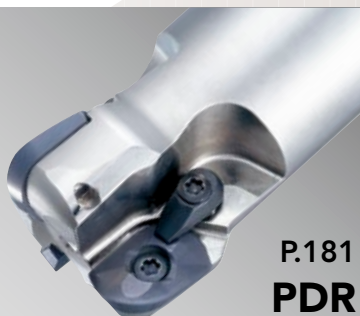

P.181

PDR

高送りラジラスカッタ
High Feed Radius Cutter



P.189

PFAL

アルミ用仕上げカッタ
Finishing Cutter for Aluminum



P.199

PFB

New Insert

仕上げ用ボールエンドミル
Finishing Ball End Mill

インデキサブルツールの動画はこちら

Watch indexable tooling in action

製品紹介動画と加工動画を公開しています
Scan to view product introduction and processing videos



フライス加工 Milling



P.83
PAS

正面フライス スクエアタイプ
45° Face Milling Square Insert Type



P.87
PAO

正面フライス オクタゴンタイプ
45° Face Milling Octagon Insert Type



P.93
PSF

4コーナ肩削りカッタ
4-corner Shoulder Cutter



P.97
PSFL

4コーナラフィングエンドミル
4-Corner Roughing End Mill



New
Size

P.103
PSE

肩削りカッタ
Shoulder Cutter



NEW

P.145
PMD

多機能カッタ
Multi-function Cutter



P.157
PHC

高送りラジアスカッタ
High Feed Cutter



P.171
PRC

丸駒カッタ
Radius Cutter



P.221
PFR

仕上げ用ラジアスエンドミル
Finishing Radius End Mill



New
Size

P.237
SF

ねじ込みタイプ
Screw-Fit Type



New
Size

P.245
PXM

ヘッド交換式エンドミル
Exchangeable Head End Mill

PDZ

NEW

P.59~

インデキサブルフラットドリル 2D/3D

Indexable Flat Drill

- ◎ 2D/3Dタイプ：φ16 ~ φ43
Type
- ◎ 安定した穴底フラット加工を実現
Achieves stable flat-bottom hole machining
- ◎ 豊富なラインナップ
Broad size lineup
- ◎ 旋盤での工具集約も実現
Enables tool consolidation on lathes



PLDS

NEW

P.77~

インデキサブルリーディングドリル

Centering and Chamfering Cutter

- ◎ 1本でセンタリング(もみつけ)、面取り、V溝加工が可能
Centering, countersinking and V slotting can be performed with a single tool
- ◎ 耐チップング性と切れ味を両立した経済的な
3コーナ仕様インサート
Economical 3-corner insert with both chipping resistance and sharpness
- ◎ 工具の長寿命化と良好な加工面を実現する
ボディ設計
Optimal body design that enables long tool life and excellent machining surface

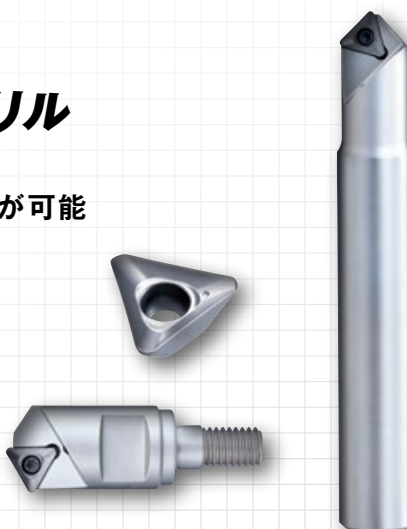

PSE

New Size

P.103~

肩削りカッタ

Shoulder Cutter

- ◎ 07サイズインサート追加
New size 07 insert
 - ・ストレートシャンクタイプ：φ10 ~ φ26
Straight Shank Type
 - ・ねじ込みタイプ：φ10 ~ φ32
Screw Fit Type
- ◎ 自動旋盤対応サイズをラインナップ
(PSE07の一部サイズ)
Lineup of sizes compatible with sliding head lathes (partial size listing of PSE07)
 - ・ストレートシャンクタイプ：φ10 ~ φ25
Straight Shank Type

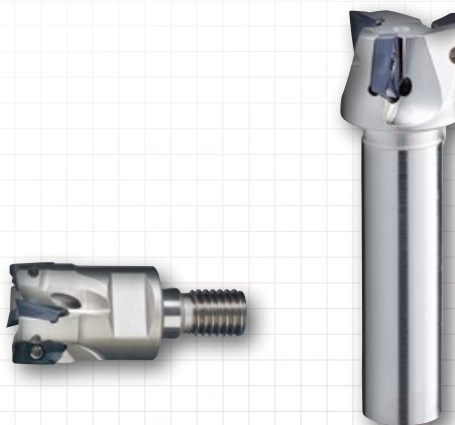
自動旋盤対応サイズ
Size compatible for sliding head lathes

PSTW **New Size**
P.135~

6コーナ肩削りカッタ

6-Corner Shoulder Cutter

- ◎ 09サイズインサート追加
New size 09 insert
- ◎ ストレートシャンクタイプ追加：φ25～φ40
New straight shank type
- ◎ ボアタイプ(09サイズ)追加：φ40～φ63
New bore type (size 09)

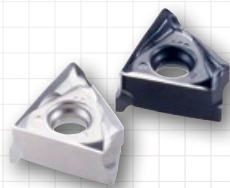

PMD **NEW**
P.145~

多機能カッタ

Multi-function Cutter

- ◎ 一本で様々な加工形態に対応
Supports a wide range of applications with a single tool
- ◎ 2種類のインサートを使用することで「突込み → 横引き」の連続加工が可能
Two types of inserts are used to enable continuous cutting - from plunging to horizontal milling

底刃用インサート
Inserts for Drilling and Plunging Edge



外周刃用インサート
Insert for Peripheral Cutting Edge



- ◎ 穴底フラット
Flat Bottom Hole
- ◎ 穴加工で高い切りくず分断性
Superior chip breaking capability during drilling and plunging
- ◎ 加工用途に合わせたインサートバリエーション
Insert lineup corresponding to individual application needs



PFB

New Size

P.199~

仕上げ用ボールエンドミル

Finishing Ball End Mill

- ◎ 高硬度鋼用インサート材種：XP6703追加

Insert grade for high-hardness steel : XP6703 added

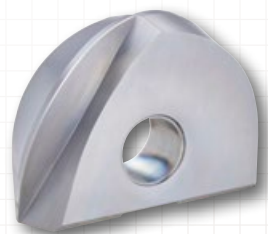

バレル型(PFB-BR)・レンズ型(PFB-LZ) インサート追加

Barrel type (PFB-BR) and lens type (PFB-LZ) inserts added

- ◎ 独自の形状で、滑らかな加工面と高能率加工を実現
Original geometry that enables smooth machined surface and higher cutting efficiency
- ◎ 用途に合わせて選べるインサート材種
Insert grade can be selected according to application
・XP3225 ・XP3310

バレル型(PFB-BR)
Barrel Typeレンズ型(PFB-LZ)
Lens Type

PXM

New Size

P.245~

ヘッド交換式エンドミル

Exchangeable Head End Mill

- ◎ 非鉄用ヘッドPXAL追加：φ10～φ25
PXAL exchangeable head for non-ferrous materials : φ10 to φ25 added
 - ・非鉄金属に適した材種XP4625採用
Utilizes XP4625 grade suitable for non-ferrous metal applications
 - ・耐溶着性や潤滑性が求められるアルミニウム合金などの非鉄金属に抜群の威力を発揮するDLC-IGUSSコーティング採用
Adopted DLC-IGUSS coating that demonstrates outstanding performance in non-ferrous materials such as aluminum alloys that require welding resistance and lubricity
- ◎ 高硬度鋼用ヘッドPXSH追加：φ12～φ25
PXSH exchangeable head for high-hardness steel : φ12 to φ25 added
 - ・高硬度鋼加工に適した材種XP6703採用
Utilizes XP6703 grade suitable for high-hardness steel applications
 - ・高硬度鋼加工に最適化された超耐熱性・高じん性のDUOREYコーティング採用
Newly developed DUOREY coating enables superior heat resistance and high toughness optimized for high-hardness steel milling
 - ・最適化された刃先仕様により 高硬度鋼を安定加工
Optimal cutting edge specifications to enable stable machining of high-hardness steels
- ◎ アディティブ・マニファクチャリング用ヘッドPXHF-AM追加：φ12～φ20
PXHF-AM exchangeable head for additive manufacturing : φ12 to φ20 added
 - ・高硬度な金属積層部の高送り加工を実現
Enables high feed milling of high-hardness additive manufacturing parts
 - ・高硬度鋼加工に適した材種XP6703採用
Utilizes XP6703 grade suitable for high-hardness steel applications
 - ・高硬度鋼加工に最適化された超耐熱性・高じん性のDUOREYコーティング採用
Newly developed DUOREY coating enables superior heat resistance and high toughness optimized for high-hardness steel milling

PXAL

オイルホール無し
without Coolant Hole

PXSH

オイルホール無し
without Coolant Hole

PXHF-AM

オイルホール付き
with Coolant Hole

Designation (Body)

ボディの表示方法

PHC	12	R	050	SS	42	-	4	S
①	②	③	④	⑤	⑥		⑦	⑧

① 製品記号
Abbreviation

例:
PHC=
高送りラジラスカッタ
High Feed Cutter

③ 勝手
Cutting Direction

R=右勝手
Right hand

L=左勝手
Left hand

② インサートサイズ
Insert Size

例:
12=12mm

④ カッタ径
Cutter Diameter

例:
050=50mm

⑥ 取り付けの径
Mounting Diameter

例:
42=42mm

⑦ 刃数
No. of Flute

例:
4=4枚刃
Flute

⑤ 取り付けのタイプ
Mounting Type

A	ボアタイプ(インチ) Bore Type (Inch)
M	ボアタイプ(ミリ) Bore Type (Metric)
SA	ストレートシャンク(インチ) Straight Shank (Inch)
SS	ストレートシャンク(ミリ) Straight Shank (Metric)
MT	モールス テーパー シャンク Morse Taper Shank
SF	ねじ込みタイプ Screw Fit Type
FS	切欠き付きタイプ Flat Shank

⑧ シャンクタイプ
Shank Type

S	ショート Short
L	ロング Long
LL	エキストラロング Extra Long

Designation (Insert)

インサートの表示方法

Z	D	K	T
①	②	③	④

① 形状 Shape of Insert		
C	菱形頂角80° Diamond apex 80°	
D	菱形頂角55° Diamond apex 55°	
O	正八角形 Octagon	
R	円形 Round	
S	正方形 Square	
T	正三角形 Triangle	
V	菱形頂角35° Diamond apex 35°	
W	不等角六角形 Axiometric hexagon	
Z	その他の形状 Other shapes	—

② 逃げ角 Clearance Angle		
A	3°	
C	7°	
D	15°	
E	20°	
N	0°	
P	11°	
X	特殊形状 Special Dimension	

③ 公差 Tolerance			
記号 Symbol	内接円 許容差 IC(mm) Inscribed circle tolerance	コーナ高さ 許容差 M (mm) Corner height tolerance	厚さ 許容差 S (mm) Thickness tolerance
A	±0.025	±0.005	±0.025
C	±0.025	±0.013	±0.025
E	±0.025	±0.025	±0.025
H	±0.013	±0.013	±0.025
K *	±0.05~±0.15	±0.013	±0.025
M *	±0.05~±0.15	±0.08~±0.18	±0.13
N *	±0.05~±0.15	±0.08~±0.18	±0.025

※印：側面は焼結肌のインサート Sintered insert shown on the side
注：製品によっては異なる場合があります。Note: Above values may vary depend on product

④ インサートブレーカ Feature of Insert			
記号 Symbol	穴の形状 Shape of Hole	ブレーカの有無 With or without Breaker	インサート断面 Insert cross section
W	一部円筒穴片面取 (40° ~ 60°) Partial cylindrical hole	なし No breaker	
T		片面 One side	
B	一部円筒穴片面取 (70° ~ 90°) Partial cylindrical hole	なし No breaker	
U		両面 Both side	
N	—	なし No breaker	
R	—	片面 One side	

15	05	08	S	R	-	GM
⑤	⑥	⑦	⑧	⑨	-	⑩

⑤ 切れ刃の長さ L Length of Cutting Edge

O	
R	
S	
T	
Z	

⑦ コーナ記号 Corner Radius

記号 Symbol	コーナ半径 RE
02	R0.2
04	R0.4
08	R0.8
12	R1.2
16	R1.6
24	R2.4

⑨ 勝手 Cutting Direction

記号 Symbol	勝手 Cutting Direction
R	右勝手 Right hand
L	左勝手 Left hand
N	左右共用 Both ways

⑥ 厚さ S Thickness of Insert

記号 Symbol	厚さ S (mm) Thickness
02	2.38
03	3.18
T3	3.97
04	4.76
05	5.56
06	6.35

⑧ 主切れ刃記号 Type of Cutting Edge



記号 Symbol	形状 Appearance
F	 シャープエッジ Sharp edge
E	 丸ホーニング Round honing
T	 チャンファホーニング Chamfer honing
S	 コンビネーションホーニング Combination honing

⑩ ブレーカ記号 Type of Insert Breaker

記号 Symbol	名称 Name
DN	DNブレーカ breaker
DM	DMブレーカ breaker
DR	DRブレーカ breaker
NM	NMブレーカ breaker
GL	GLブレーカ breaker
GM	GMブレーカ breaker
GR	GRブレーカ breaker
HR	HRブレーカ breaker
SM	SMブレーカ breaker

Type of Insert Breakers

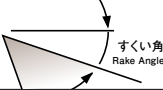
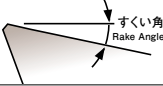
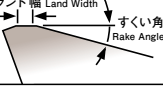
ブレーカの種類と用途 Type of Insert Breakers

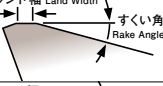
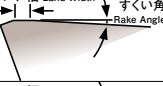
	ブレーカ名 Insert Breaker	切刃断面形状(目安) Cutting edge cross-section (approximate)	用途 Application
ドリル用 For Drilling	DN	 すくい角 Rake Angle	シャープな切れ刃とポリッシュ処理による切りくず排出性に優れた非鉄金属加工用ブレーカ For drilling non-ferrous material: a breaker with sharp cutting edge and polish treatment for excellent chip evacuation.
	DM	 すくい角 Rake Angle	最適すくい角により様々な被削材に対応可能な汎用ブレーカ General purpose breaker with an optimum rake angle suitable for various work materials.
	DR	 ランド幅 Land Width すくい角 Rake Angle	すくい角とランドによる刃先強度に優れた鋳鉄加工用ブレーカ For drilling cast iron: a breaker with high rigidity acquired by optimal land width and rake angle.
フライス用 For Milling	NM	 すくい角 Rake Angle	シャープな切れ刃と大きなすくい角で凝着を抑制し、加工面の向上とバリ発生を防ぐ 非鉄金属加工用ブレーカ For machining nonferrous materials: a breaker with a sharp cutting edge and a large rake angle to suppress welding, improve the milling surface and prevent burrs.
	GL	 ランド幅 Land Width すくい角 Rake Angle	大きなすくい角と小さなフラットランドにより、切削抵抗を小さくした低抵抗形ブレーカ For milling stainless-steel: a breaker with a large rake angle and a small flat land to reduce cutting force.
	GM	 ランド幅 Land Width すくい角 Rake Angle	すくい角とフラットランドの高バランス化により、鋼～鋳鉄まで加工可能な汎用ブレーカ For drilling various materials from steel to cast iron: a breaker with a superior balance of rake angle and flat land.
	GR	 ランド幅 Land Width すくい角 Rake Angle	すくい角とフラットランドにより、刃先強度が高く鋳鉄・高硬度材加工向けの高剛性ブレーカ For machining cast iron and high-hardness materials: a highly rigid breaker with optimal rake angle and flat land specification for high cutting edge strength.
	HR	 ランド幅 Land Width すくい角 Rake Angle	シャープな切れ味と剛性を兼ね備えた高硬度鋼加工用ブレーカ For milling high hardened steel: a breaker with sharpness and rigidity on the cutting edge.
	SM	 すくい角 Rake Angle	シャープな切れ味により切削抵抗の低減とスムーズな切りくず排出が可能となる 難削材加工用ブレーカ For machining difficult materials: a breaker with a sharp cutting edge to reduce cutting force and provide smooth chip evacuation.

Type of Inserts

ドリル インサート材種一覧 List of insert grades for Drill

分類 Classification	材種 Grades	コーティング法 Coating Method	母材硬度 (HRA) Hardness	コーティング層 Surface Treatment		特長 Features	対象製品 Product					
				主成分 Main Component	膜厚 Coating Thickness		PXD	PD	PHP	PDZ	PLDS	
P	XP3425	PVD	91.8	Cr系 複合多層 Composite multilayer	7μm	鋼加工用材種 For steel 厚膜のコーティングを施し、耐磨耗性に優れたPXD専用材種 Thick-film coating, wear-resistant material, for PXD operation	○					
	XP8030	PVD	91.9	TiAlN	3μm	鋼・ステンレス鋼加工用材種 For steel and stainless steel 幅広い用途、領域に対応可能、耐磨耗性と耐欠損性がバランスした材種 Wide range of applications and areas, well-balanced wear resistance and defect resistance				○		
	XC8035	CVD	89.6	TiCN+Al ₂ O ₃	7μm	鋼・鋳鉄加工用材種 For steel and cast iron 高強度高じん性の超硬母材と耐磨耗性に優れたコーティング被膜の鋼・鋳鉄加工用材種 High-strength and tough material, wear-resistant coating, for steel and cast iron				○		
	XP9020	PVD	91.9	TiAlN系	3μm	鋼・ステンレス鋼加工用材種 For steel and stainless steel 幅広い用途、領域に対応可能、耐磨耗性と耐欠損性がバランスした穴あけ専用材種 Wide range of applications and areas, well-balanced wear resistance and defect resistance, for drilling operation		○				○
	XP9040	PVD	91.9	TiAlN系	3μm	鋼・ステンレス鋼加工用材種 For steel and stainless steel 強じんな超硬母材と耐チッピング性及び耐磨耗性に優れたコーティング被膜の穴あけ専用材種 High-strength material, chipping-resistant and wear-resistant coating, for drilling operation				○		
	XC9015	CVD	91.9	TiCN+Al ₂ O ₃	7μm	鋼・鋳鉄加工用材種 For steel and cast iron 強靱な超硬母材と厚膜のCVDコーティングにより、耐磨耗性に優れた鋼・鋳鉄専用材種 High-strength material, thick-film CVD coating, wear-resistant material, for steel and cast iron			○			
M	XP2040	PVD	89.6	TiAlN系	5μm	ステンレス鋼・鋼加工用材種 For stainless steel and steel 強じんな超硬母材と耐チッピング性及び耐磨耗性に優れたコーティング被膜の汎用フライス用材種 High-strength material, chipping-resistant and wear-resistant coating, for general purpose milling operation						○
K	XP1010	PVD	91.4	TiAlN系	6μm	鋳鉄加工用材種 For cast iron すくい角とランドによる刃先強度に優れた鋳鉄用材種 High rigidity of cutting edge is acquired by optimal land width and rake angle.		○				
	XP1425	PVD	91.8	Cr系 複合多層 Composite multilayer	7μm	鋳鉄加工用材種 For cast iron 高じん性な母材に耐磨耗性に優れた厚膜コーティングを施したPXD専用材種 Non-coated fine grain hard metal with high strength and toughness, specifically for PXD operation	○					
	XC9025	CVD	90.8	TiCN+Al ₂ O ₃	6μm	鋳鉄加工用材種 For cast iron 高強度高じん性の超硬母材と耐磨耗性に優れたコーティング被膜の鋳鉄穴あけ専用材種 High-strength and tough material, wear-resistant coating, for drilling operation				○		
N	CK110	—	92.2	—	—	アルミニウム合金・非鉄用材種 For aluminum alloy and non-ferrous material シャープな切れ刃とポリッシュ処理を備えた非鉄金属加工用材種 Sharp cutting edge with polish treatment			○			
	CF225	—	91.8	—	—	非鉄金属加工用材種 For non-ferrous material 優れた強度と高い硬度を兼ね備えたノンコート微粒超硬合金、PXD専用材種 High-strength and tough non-coat fine grain hard metal, for PXD operation	○					

○ = Applicable

PFB、PFR、PXM インサート材種一覧 List of insert grades for PFB, PFR, PXM

分類 Classification	材種 Grades	コーティング法 Coating Method	母材硬度 (HRA) Hardness	コーティング層 Surface Treatment		特長 Features	対象製品 Product		
				主成分 Main Component	膜厚 Coating Thickness		PFB	PFR	PXM
P	XP3225	PVD	91.5	Cr系	3μm	鋼・ステンレス鋼・鋳鉄加工用材種 For steel, stainless steel, and cast iron 強じんな超硬母材と広い汎用性に優れたコーティング被膜 High-strength material, excellent coating for general purpose	○	○	○
	XP3310	PVD	92.5	SiC含有耐熱強化被膜 SiC based heat-resistant coating	3μm	鋼・鋳鉄加工用材種 For steel and cast iron 高強度高じん性の超硬母材と耐磨耗性に優れたコーティング被膜の鋳鉄、高硬度鋼専用材種 High-strength and tough material, wear-resistant coating	○	○	
	XP3320	PVD	91.5	SiC含有耐熱強化被膜 SiC based heat-resistant coating	3μm	鋼・ステンレス鋼・鋳鉄加工用材種 For steel, stainless steel, and cast iron 強じんな超硬母材と耐熱性及び耐磨耗性に優れたコーティング被膜 High-strength material, heat-resistant and wear-resistant coating	○		○
M	XP2225	PVD	91.5	Cr系	3μm	ステンレス鋼加工用材種 For stainless steel 耐熱性に優れた超硬母材とコーティング被膜のステンレス鋼加工用材種 Heat-resistant material, coating for stainless steel		○	
N	XC4505	CVD	93.0	DIA	12μm	非鉄金属加工用材種 For non-ferrous material 微細なダイヤモンド結晶による、高い被膜強度に優れたコーティング被膜 High-strength coating of fine diamond	○	○	
	XP4625	PVD	91.5	DLC(SP ³ リッチ) SP ³ Rich	0.8μm	非鉄金属に適した材種 For non-ferrous materials コーティング表面の平滑性により耐摩耗性・耐溶着性に優れた材種 Excellent wear resistance and welding resistance due to the smoothness of the coating surface			○
H	XP6305	PVD	93.0	SiC含有耐熱強化被膜 SiC based heat-resistant coating	3μm	高硬度鋼加工用材種 For high hardness steel 高い高温強度と熱伝導性に優れた高硬度材加工用材種 High temperature strength and excellent thermal conductivity			○
	XP6703	PVD	93.5	SiC含超耐熱複合多層 SiC based super heat-resistant composite multilayer	3μm	高硬度鋼加工用材種 For high hardness steel 高い耐熱性と耐磨耗性を有しつつ、優れたじん性を発揮する高硬度材加工用材種 Demonstrates excellent toughness with high heat resistance and wear resistance in high-hardness materials		○	○

○ = Applicable

Type of Inserts

ミーリング インサート材種一覧 List of insert grades for Milling

分類 Classification	材種 Grades	コーティング法 Coating Method	母材硬度 (HRA) Hardness	コーティング層 Surface Treatment		特長 Features
				主成分 Main Component	膜厚 Coating Thickness	
P	XC3020	CVD	90.5	TiCN+Al ₂ O ₃	10μm	鋼・鋳鉄加工用材種 For steel and cast iron 高強度高じん性の超硬母材と耐摩耗性に優れたコーティング被膜 High-strength and tough material, wear-resistant coating
	XP3025	PVD	90.5	TiAlN系	5μm	鋼・鋳鉄加工用材種 For steel and cast iron 高強度高じん性の超硬母材と耐摩耗性に優れたコーティング被膜 High-strength and tough material, wear-resistant coating
	XC3025	CVD	90.8	TiCN+TiN+Al ₂ O ₃	4μm	鋼・ステンレス鋼・鋳鉄加工用材種 For steel, stainless steel, and cast iron 強じんな超硬母材と耐摩耗性に優れたコーティング被膜 High-strength material, excellent wear-resistant coating
	XC3030	CVD	89.5	TiCN+Al ₂ O ₃	10μm	鋼・鋳鉄加工用材種 For steel and cast iron 高強度高じん性の超硬母材と耐摩耗性に優れたコーティング被膜 High-strength and tough material, wear-resistant coating
	XP3035	PVD	89.5	TiAlN系	5μm	鋼・ステンレス鋼・鋳鉄加工用材種 For steel, stainless steel, and cast iron 高強度高じん性の超硬母材と耐チッピング性及び耐摩耗性に優れたコーティング被膜の汎用フライス用材種 High-strength and tough material, chipping-resistant and wear-resistant coating, for general purpose milling operation
	XP3930	PVD	90.8	TiAlN	3μm	鋼・鋳鉄・ステンレス鋼加工用材種 For steel, cast iron, and stainless steel バランスに優れ、多くの被削材に対応可能な汎用材種 For a wide variety of work material
	XP8030	PVD	91.9	TiAlN	3μm	鋼・ステンレス鋼加工用材種 For steel and stainless steel 幅広い用途、領域に対応可能、耐摩耗性と耐欠損性がバランスした材種 Wide range of applications and areas, well-balanced wear resistance and defect resistance
	XC8035	CVD	89.6	TiCN+Al ₂ O ₃	7μm	鋼・鋳鉄加工用材種 For steel and cast iron 高強度高じん性の超硬母材と耐摩耗性に優れたコーティング被膜の鋼・鋳鉄加工用材種 High-strength and tough material, wear-resistant coating, for steel and cast iron
M	XP2025	PVD	91.0	TiAlN系	5μm	ステンレス鋼・鋼加工用材種 For stainless steel and steel 耐摩耗性に優れた超硬母材とコーティング被膜 Composed of a tough carbide material with a wear resistant coating
	XP2040	PVD	89.6	TiAlN系	5μm	ステンレス鋼・鋼加工用材種 For stainless steel and steel 強じんな超硬母材と耐チッピング性及び耐摩耗性に優れたコーティング被膜の汎用フライス用材種 High-strength material, chipping-resistant and wear-resistant coating, for general purpose milling operation
K	XC1015	CVD	91.5	TiCN+Al ₂ O ₃	10μm	鋳鉄加工用材種 For cast iron 高強度高じん性の超硬母材と耐摩耗性に優れたコーティング被膜の鋳鉄フライス専用材種 High-strength and tough material, wear-resistant coating, for milling operation
	XP1020	PVD	91.5	TiAlN系	5μm	鋳鉄加工用材種 For cast iron 高強度高じん性の超硬母材と耐摩耗性に優れたコーティング被膜の鋳鉄フライス専用材種 High-strength and tough material, wear-resistant coating, for milling operation
N	CK010	—	92.0	—	—	非鉄金属加工用材種 For non-ferrous material 耐チッピング性及び耐摩耗性共に優れた超硬ノンコート材種 Chipping-resistant, wear-resistant material and no coating
S	XC5035	CVD	89.3	TiN+Ti(CN)+Al ₂ O ₃ +Ti(BN)	6μm	耐熱鋼・ステンレス鋼加工用材種 For heat-resistant alloy and stainless steel 強じんな超硬母材と耐酸化性及び高潤滑被膜による耐熱鋼加工用材種 High-strength material, oxidation-resistant and high-lubricity coating
	XC5040	CVD	89.3	TiN+TiB ₂	4μm	耐熱鋼・ステンレス鋼加工用材種 For heat-resistant alloy and stainless steel 強じんな超硬母材と耐酸化性及び高潤滑被膜で湿式加工可能な耐熱鋼加工用材種 High-strength material, oxidation-resistant and high-lubricity coating, for wet machining
H	XP6015	PVD	92.2	TiAlN	4μm	高硬度鋼用材種 For high-hardness steel 高強度高じん性の超硬母材と耐摩耗性に優れたコーティング被膜の高硬度鋼フライス専用材種 A grade designed for milling high-hardness steel, made of tough, high-strength carbide material with a wear-resistant coating

Application Chart

ミーリング インサート材種適用マップ Inserts Application Chart

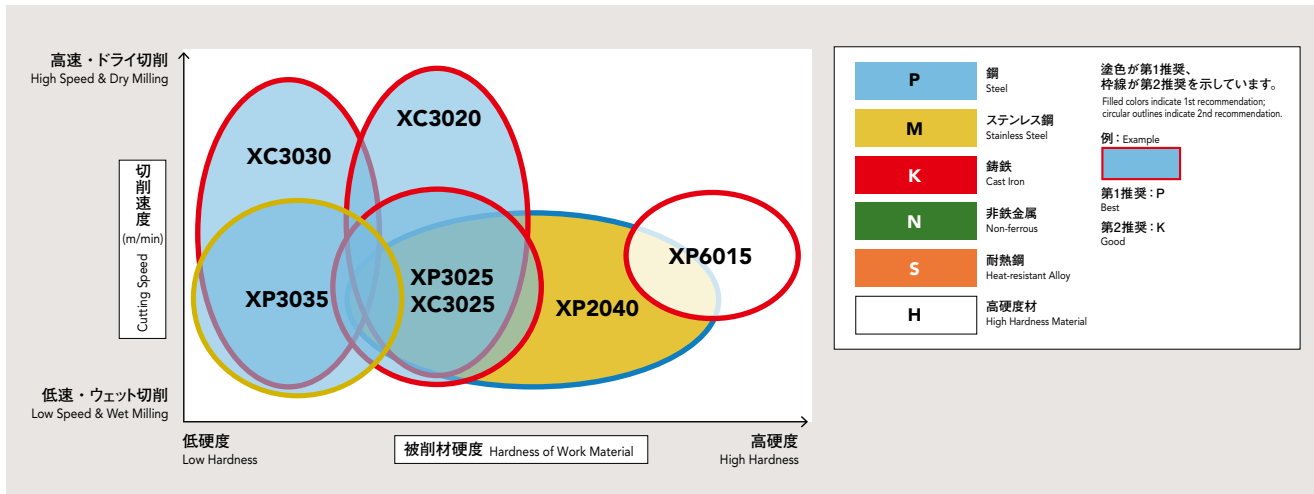

ミーリング 被削材別適用材種 Application Chart of Insert Material

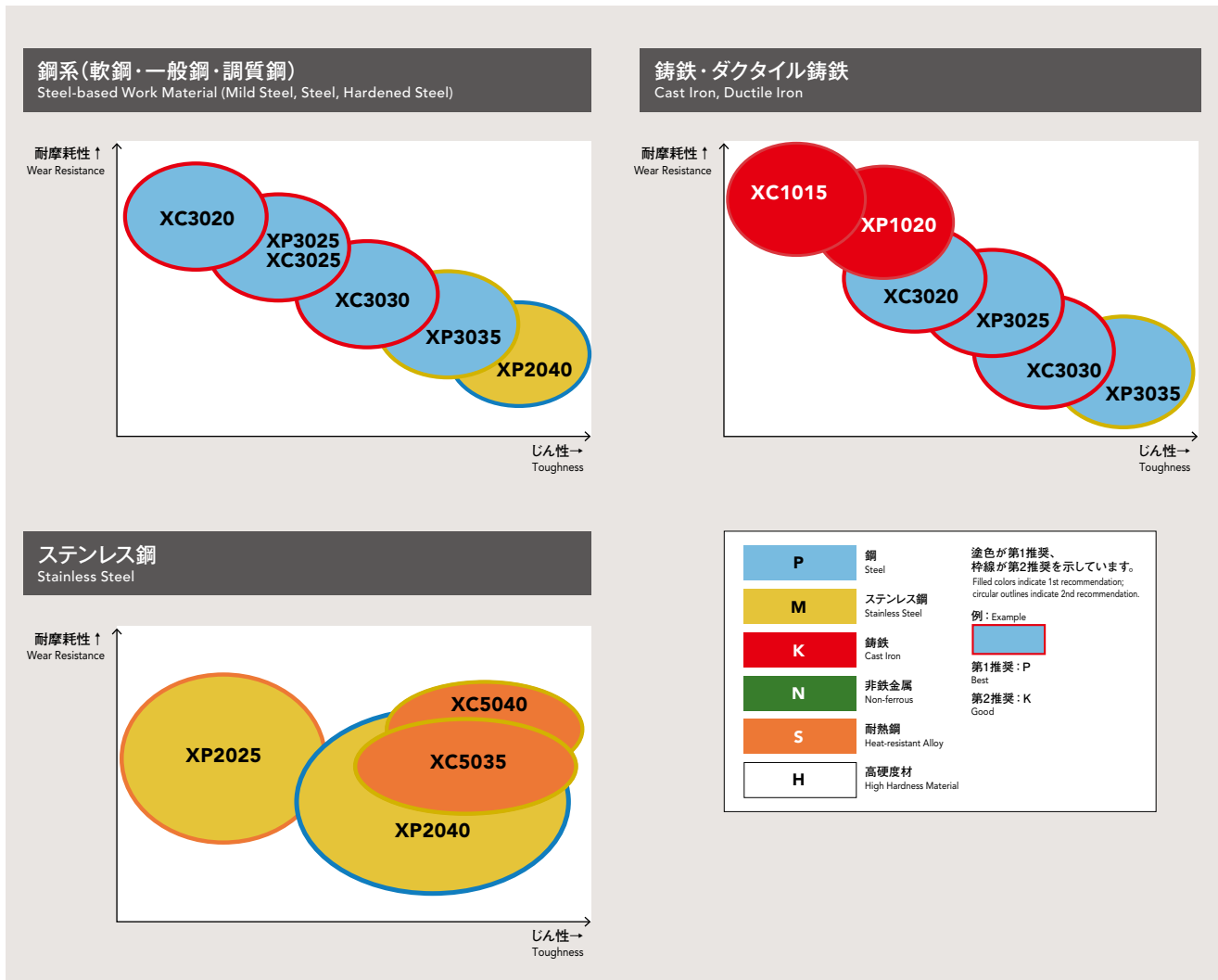

Phoenix Drills

ドリルの使い分け Drill Selection

大径の穴あけ加工をカバー

OSG's Comprehensive Product Lineup for Drilling Application

穴あけ加工対応マップ Product Guideline

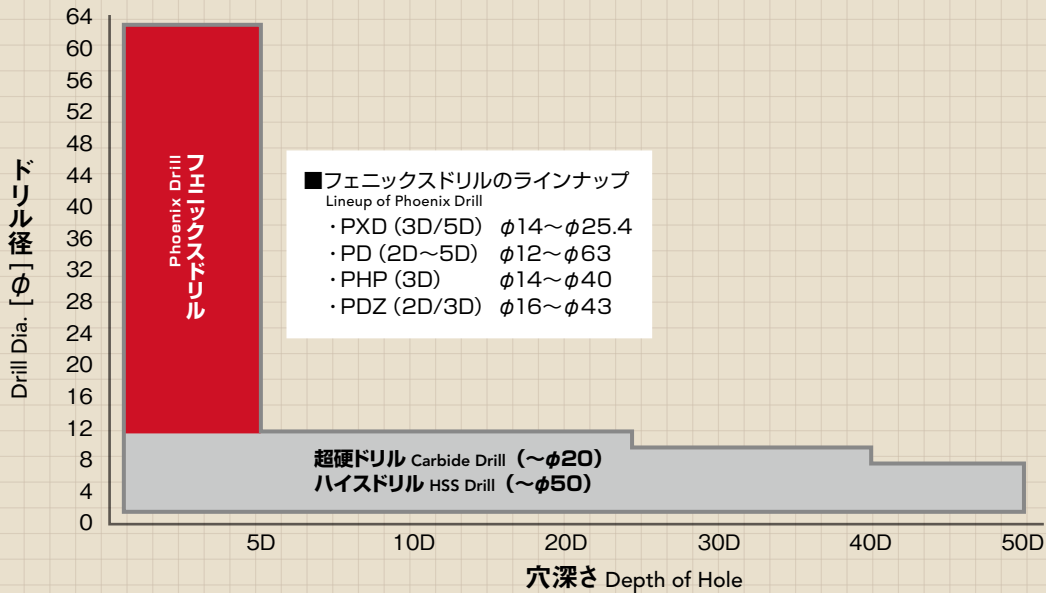

各種ドリル使い分け Drill Type by Application

				
ハイスドリル HSS Drill	超硬ドリル Carbide Drill	ヘッド交換式ドリル Exchangeable Head Drill (PXD)	インデキサブルドリル Indexable Drill (PD・PHP)	インデキサブルフラットドリル Indexable Flat Drill (PDZ)
<ul style="list-style-type: none"> ● 安定した加工 Stable drilling ● 低出力機械向け For low horsepower machines 	<ul style="list-style-type: none"> ● 高速、高能率加工 High speed, high efficiency ● 長寿命 Long tool life ● 高い穴精度 High hole accuracy 	<ul style="list-style-type: none"> ● 高速、高能率加工 High speed, high efficiency ● 長寿命 Long tool life ● 超硬ドリルと比べて低コスト Lower cost than carbide drills ● 比較的高い穴精度 Relatively high hole accuracy 	<ul style="list-style-type: none"> ● 高いコストパフォーマンス High cost performance ● 高能率加工 High efficiency operation 	<ul style="list-style-type: none"> ● 安定した穴底フラット加工を実現 Achieves stable flat-bottom hole machining ● 旋盤での工具集約も実現 Enables tool consolidation on lathes

PXD ヘッド交換式ドリル 3D/5D

Exchangeable Head Drill 3D/5D

- 超硬ドリルと同等の能率
- 穴精度が求められる加工に対応
 - ・ 転造タップの下穴に対応(3Dタイプのみ)
- ボディ1つで複数の加工サイズに対応
- 超硬ドリルより高いコストパフォーマンス
- 取付け取り外しが簡単
 - ・ ねじを使用しない、シンプルかつ強固な締結
- Efficiency: equivalent to carbide drills.
- For drilling holes that require accuracy.
 - ・ Optimal for pre-drilled holes for forming taps (3D only)
- A single cutter body is applicable for multiple drilling diameters.
- Cost performance: higher than carbide drills.
- Easy attachment and removal.
 - ・ Screwless, simple but firm fastening.



P.17 ~

PD インデキサブルドリル 2D/3D/4D/5D

Indexable Drill 2D/3D/4D/5D

- 溝面の仕上げ処理により、高送り条件での加工が可能に!
- 外周・中心に同一インサートを使用し、工具管理を容易化!
- さらに耐久性を高める外周刃専用インサートが追加!
- Finishing treatment on flute surface enables high feed machining.
- Using same insert to both center and peripheral cutting edges simplify tool management.
- Expanded with new peripheral insert for improved durability.



P.33 ~

PHP インデキサブルドリル 3D

Indexable Drill 3D

- 先端角形状により、不安定な加工形態に対応
 - ・ 傾斜面、鑄肌面、重ね板
- ハイスドリルの低速領域でも加工可能
- Shaped corner tips for unstable drilling shapes.
 - ・ Inclined surface, cast surface and stacked plates.
- Possible to drill even in low-speed HSS areas.



P.53 ~

PDZ インデキサブルフラットドリル 2D/3D

Indexable Flat Drill 2D/3D

- 安定した穴底フラット加工を実現
- 旋盤での工具集約も実現
- Achieves stable flat-bottom hole machining
- Enables tool consolidation on lathes



P.59 ~

PXD

PD

PHP

PDZ

PZAG

PLDS

PAS

PAO

PSF

PSFL

PSE

PSEL

PSTW

PMD

PHC

PRC

PDR

PFAL

PFB

PFR

SF

PXM

PXMC

Technical data
技術資料

Index
索引

Pre-Drilled Hole Size for Tap

タップ下穴径・推奨タップ一覧表 Recommended taps and size chart

■PXD用 for PXD

■切削タップ用 for Cutting Tap

ねじの呼び Thread Size	推奨下穴径 Recommended drill hole dia.	最小下穴径 Min. drill hole dia.	最大下穴径 Max. drill hole dia.		適用 PXDヘッド Applicable PXD head	推奨タップ ツールNo. Recommended Tap No.	
		各精度共通	旧JIS2級用	6H用		A-SFT	A-POT
M 15 × 1	14	13.95	14.15	14.15	PXDH1400...	8325356	8325156
M 16 × 2	14	13.9	14.2	14.21	PXDH1400...	8325357	8325157
M 16 × 1.5	14.5	14.4	14.6	14.67	PXDH1450...	8325360	8325160
M 16 × 1	15	14.95	15.15	15.15	PXDH1500...	8325362	8325162
M 17 × 1.5	15.5	15.4	15.68	15.67	PXDH1550...	8325364	8325164
M 17 × 1	16	15.95	16.15	16.15	PXDH1600...	8325366	8325166
M 18 × 2.5	15.5	15.3	15.7	15.74	PXDH1550...	8325367	3825167
M 18 × 2	16	15.9	16.2	16.21	PXDH1600...	8325369	8325169
M 18 × 1.5	16.5	16.4	16.6	16.67	PXDH1650...	8325370	8325170
M 18 × 1	17	16.95	17.15	17.15	PXDH1700...	8325372	8325172
M 20 × 2.5	17.5	17.3	17.7	17.74	PXDH1750...	8325377	8325177
M 20 × 2	18	17.9	18.2	18.21	PXDH1800...	8325379	8325179
M 20 × 1.5	18.5	18.4	18.6	18.67	PXDH1850...	8325380	8325180
M 20 × 1	19	18.95	19.15	19.15	PXDH1900...	8325382	8325182
M 22 × 2.5	19.5	19.3	19.7	19.74	PXDH1950...	8325387	8325187
M 22 × 2	20	19.9	20.2	20.21	PXDH2000...	8325389	8325189
M 22 × 1.5	20.5	20.4	20.6	20.67	PXDH2050...	8325390	8325190
M 22 × 1	21	20.95	21.15	21.15	PXDH2100...	8325392	8325192
M 24 × 3	21	20.8	21.2	21.25	PXDH2100...	8325397	8325197
M 24 × 2	22	21.9	22.2	22.21	PXDH2200...	8325399	8325199
M 24 × 1.5	22.5	22.4	22.6	22.67	PXDH2250...	8325400	8325200
M 24 × 1	23	22.95	23.15	23.15	PXDH2300...	8325402	8325202
M 27 × 3	24	23.8	24.2	24.25	PXDH2400...	8326605	-

※エンドミルシャンク、ロングシャンクのツールNo.については「高能率・多機能タップ A-TAP」カタログをご参照下さい。

※ For additional sizes and styles, please refer to the high efficiency, multi-purpose A-Tap series catalog.

■転造タップ用下穴径(3Dタイプ) for Forming Tap (PXD 3D Type)

ねじの呼び Thread Size	推奨下穴径 Recommended drill hole dia.	旧JIS2級用				適用 PXDヘッド Applicable PXD head	推奨タップ ツールNo. Recommended Tap No.
		精度表記 Grade	タップ精度 RH Limit	最小下穴径 Min. drill hole dia.	最大下穴径 Max. drill hole dia.		S-XPf
M 16 × 2	14.95	STD	RH10	14.92	15.04	PXDH1495...	8322245
M 16 × 1.5	15.25	STD	RH 9	15.21	15.3	PXDH1525...	8322255
M 18 × 2.5	16.7	STD	RH11	16.63	16.78	PXDH1670...	8322263
M 18 × 1.5	17.25	STD	RH10	17.22	17.31	PXDH1725...	8322267
M 20 × 2.5	18.7	STD	RH11	18.63	18.78	PXDH1870...	8322273
M 20 × 1.5	19.25	STD	RH10	19.22	19.31	PXDH1925...	8322277
M 22 × 2.5	20.7	STD	RH11	20.63	20.78	PXDH2070...	8322283
M 22 × 1.5	21.25	STD	RH10	21.22	21.31	PXDH2125...	8322287
M 24 × 3	22.4	STD	RH13	22.36	22.53	PXDH2240...	8322295
M 24 × 1.5	23.25	STD	RH10	23.22	23.31	PXDH2325...	8322299
M 27 × 3	25.4	STD	RH13	25.36	25.53	PXDH2540...	8322305

※ PXD 3Dタイプをご使用下さい。PDならびにPXD 5Dタイプは、転造タップの下穴加工を推奨しておりません。

※ Xバフォーマー転造タップロングシャンク(LT-S-XPf)の下穴には対応しておりません。

※ For pre-drilled hole of forming tap, PXD 3D should be used. PD and PXD 5D are not recommended.

※ Not compatible with the XPf long shank forming tap (LT-S-XPf).

■ P2D/P3D・PHP・PDZ 用 for P2D/P3D, PHP and PDZ

■ 切削タップ用 for Cutting Tap

ねじの呼び Thread Size	推奨 下穴径 Recommended drill hole diameter	最小 下穴径 Min. drill hole dia.			最大下穴径 Max. drill hole dia.					適応ボディ Applicable Body			推奨タップ ツールNo. Recommended Tap No.	
		各精度 共通	旧 JIS 2級用	6H用	P2D	P3D	PHP	PDZ (2Dタイプ)	PDZ (3Dタイプ)	A-SFT	A-POT			
M 14 × 2	12	11.84	12.21	12.21	P2D1200FS20M03	P3D1200FS20M03	-	-	-	8325347	-			
M 14 × 1.5	12.5	12.38	12.67	12.67	P2D1250FS20M03	P3D1250FS20M03	-	-	-	8325350	-			
M 16 × 2	14	13.9	14.2	14.21	P2D1400FS20M03	P3D1400FS20M03	PHP140FS20M04-3D	-	-	8325357	8325157			
M 16 × 1.5	14.5	14.4	14.6	14.67	P2D1450FS20M03	P3D1450FS20M03	PHP145FS20M04-3D	-	-	8325360	8325160			
M 17 × 1.5	15.5	15.4	15.68	15.67	P2D1550FS20M04	P3D1550FS20M04	PHP155FS20M04-3D	-	-	8325364	8325164			
M 18 × 2.5	15.5	15.3	15.7	15.74				-	-	8325367	3825167			
M 18 × 2	16	15.9	16.2	16.21	P2D1600FS20M04	P3D1600FS20M04	PHP160FS20M04-3D	PDZ1600FS20M05-2D	PDZ1600FS20M05-3D	8325369	8325169			
M 18 × 1.5	16.5	16.4	16.6	16.67	P2D1650FS20M04	P3D1650FS20M04	PHP165FS20M05-3D	PDZ1650FS20M05-2D	PDZ1650FS20M05-3D	8325370	8325170			
M 20 × 2.5	17.5	17.3	17.7	17.74	P2D1750FS20M05	P3D1750FS20M05	PHP175FS25M05-3D	PDZ1750FS25M05-2D	PDZ1750FS25M05-3D	8325377	8325177			
					P2D1750FS25M05	P3D1750FS25M05								
M 20 × 2	18	17.9	18.2	18.21	P2D1800FS25M05	P3D1800FS25M05	PHP180FS25M05-3D	PDZ1800FS25M05-2D	PDZ1800FS25M05-3D	8325379	8325179			
M 20 × 1.5	18.5	18.4	18.6	18.67	P2D1850FS25M05	P3D1850FS25M05	PHP185FS25M06-3D	PDZ1850FS25M05-2D	PDZ1850FS25M05-3D	8325380	8325180			
M 22 × 2.5	19.5	19.3	19.7	19.74	P2D1950FS25M06	P3D1950FS25M06	PHP195FS25M06-3D	PDZ1950FS25M06-2D	PDZ1950FS25M06-3D	8325387	8325187			
M 22 × 2	20	19.9	20.2	20.21	P2D2000FS25M06	P3D2000FS25M06	PHP200FS25M06-3D	PDZ2000FS25M06-2D	PDZ2000FS25M06-3D	8325389	8325189			
M 22 × 1.5	20.5	20.4	20.6	20.67	P2D2050FS20M06	P3D2050FS20M06	PHP205FS25M06-3D	-	-	8325390	8325190			
M 24 × 3	21	20.8	21.2	21.25	P2D2100FS25M07	P3D2100FS25M07	PHP210FS25M07-3D	PDZ2100FS25M06-2D	PDZ2100FS25M06-3D	8325397	8325197			
M 24 × 2	22	21.9	22.2	22.21	P2D2200FS25M07	P3D2200FS25M07	PHP220FS25M07-3D	PDZ2200FS25M06-2D	PDZ2200FS25M06-3D	8325399	8325199			
M 24 × 1.5	22.5	22.4	22.6	22.67	P2D2250FS25M07	P3D2250FS25M07	PHP225FS25M07-3D	-	-	8325400	8325200			
M 27 × 3	24	23.8	24.2	24.25	P2D2400FS25M07	P3D2400FS25M07	PHP240FS32M07-3D	PDZ2400FS25M07-2D	PDZ2400FS25M07-3D	8326605				
					P2D2400FS32M07	P3D2400FS32M07								
M 27 × 1.5	25.5	25.4	25.6	25.67	P2D2550FS25M08	P3D2550FS25M08	PHP255FS32M08-3D	-	-	8326608				
					P2D2550FS32M08	P3D2550FS32M08								
M 30 × 3.5	26.5	26.3	26.7	26.77	P2D2650FS32M08	P3D2650FS32M08	PHP265FS32M08-3D	-	-	8326614				
M 30 × 3	27	26.8	27.2	27.25	P2D2700FS32M08	P3D2700FS32M08	PHP270FS32M08-3D	PDZ2700FS32M08-2D	PDZ2700FS32M08-3D	8326615				
M 30 × 1.5	28.5	28.4	28.6	28.67	P2D2850FS32M08	P3D2850FS32M08	-	-	-	8326618				
M 33 × 3.5	29.5	29.3	29.7	29.77	-	P3D2950FS32M09	-	-	-	8326624				
M 33 × 3	30	29.8	30.2	30.25	P2D3000FS32M09	P3D3000FS32M09	PHP300FS32M10-3D	PDZ3000FS32M08-2D	PDZ3000FS32M08-3D	8326625				
M 33 × 1.5	31.5	31.4	31.6	31.67	-	P3D3150FS32M09	-	-	-	8326628				
M 36 × 4	32	31.7	32.2	32.27	P2D3200FS32M09	P3D3200FS32M09	PHP320FS32M10-3D	PDZ3200FS32M09-2D	PDZ3200FS32M09-3D	8326633	-			
					P2D3200FS40M09	P3D3200FS40M09								
M 36 × 3	33	32.8	33.2	33.25	P2D3300FS40M09	P3D3300FS40M09	PHP330FS40M10-3D	PDZ3300FS40M09-2D	PDZ3300FS40M09-3D	8326635				
M 36 × 1.5	34.5	34.4	34.6	34.67	-	P3D3450FS40M10	-	-	-	8326638				
M 39 × 4	35	34.7	35.2	35.27	P2D3500FS40M10	P3D3500FS40M10	PHP350FS40M12-3D	PDZ3500FS40M10-2D	PDZ3500FS40M10-3D	8326643				
M 42 × 4.5	37.5	37.2	37.7	37.79	-	P3D3750FS40M10	-	-	-	8326652				
M 42 × 3	39	38.8	39.2	39.25	P2D3900FS40M12	P3D3900FS40M12	PHP390FS40M12-3D	PDZ3900FS40M13-2D	PDZ3900FS40M13-3D	8326655				
M 42 × 1.5	40.5	40.4	40.6	40.67	-	P3D4050FS40M12	-	-	-	8326658				
M 45 × 4.5	40.5	40.2	40.7	40.79	-	-	-	-	-	8326659				
M 48 × 5	43	42.6	43.2	43.29	P2D4300FS40M12	P3D4300FS40M12	-	PDZ4300FS40M13-2D	PDZ4300FS40M13-3D	8326661				
M 48 × 3	45	44.8	45.2	45.25	P2D4500FS40M13	P3D4500FS40M13	-	-	-	8326665				
M 56 × 5.5	50.5	50.1	50.7	50.7	-	P3D5050FS40M14	-	-	-	8326670				

※エンドミルシャンク、ロングシャンクのツールNo.については「高効率・多機能タップ A-TAP」カタログをご参照下さい。
For additional sizes and styles, please refer to the high efficiency, multi-purpose A-Tap series catalog.

■ OSG Phoenixドリルでの穴開け加工の後には、Aタップ・XPFをご使用下さい。
Please use the A-Tap and XPF after drilling with the OSG Phoenix drills.

■ Aタップシリーズ A-Tap Series



切削タップにおける
安定加工の新スタンダード

The new industry standard for
stable threading.

■ XPFシリーズ XPF Series



切りくずの出ない
進化形転造タップ

Superior forming taps that
stably make threads without
creating chips.

» Phoenix PXD

ヘッド交換式ドリル3D/5D
Exchangeable Head Drill for 3D, 5D.

Phoenix Exchangeable Drill

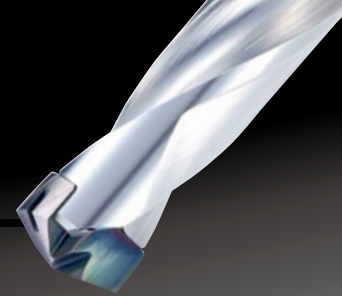

■ 特長 Features

**背抜き加工により、加工中の
切りくずのかみこみを防止**
O.D. relief grinding prevents the curling of
chips during drilling.

**内部給油により
高能率加工が可能**
Internal coolant capability enables
highly efficient drilling.

**研磨による溝仕上げ
加工により、スムーズ
な切りくず排出**
Polished flutes enable smooth
chip evacuation.

**大径加工に最適な
設計刃形**
Cutting edges designed optimally for
large-diameter drilling.

独自の方式で強固な締結

PAT. in Japan

OSG's proprietary construction ensures secure mounting.



- 独自の締結方法により、ねじを使用せずに強固な締結を実現
- ねじの強度などの不安定要素をなくし容易な取付け取り外しが可能
- With OSG's proprietary mounting system, the exchangeable head can be securely mounted without screws.
- Eliminates loose screw problems. Easy attachment and removal system.

■被削材別に最適なヘッドを選択

Exchangeable head selection based on work material



鋼用ヘッド(PC) For steel

- 鋼加工用に設計されたヘッド
Exchangeable head designed for steel
- 軟鋼～低、中炭素鋼の加工に最適
Suitable for mild steel and low to medium carbon steel



鋳鉄用ヘッド(KC) For cast iron

- 鋳鉄加工用に設計されたヘッド
Exchangeable head designed for cast iron
- 鋳鉄、ダクタイル鋳鉄の加工に最適
Suitable for cast iron and ductile cast iron



非鉄用ヘッド(NC) For non-ferrous metal

- 非鉄金属加工用に設計されたヘッド
Exchangeable head designed for non-ferrous metals
- アルミニウム合金鋳物などの加工に最適
Suitable for aluminum alloy casting

	低炭素鋼 Low Carbon Steel	中炭素鋼 Medium Carbon Steel	高炭素鋼 High Carbon Steel	合金鋼 Alloy Steel	調質鋼 Hardened Steel		鋳鉄 Cast Iron	ダクタイル 鋳鉄 Ductile Cast Iron	銅合金 Copper Alloy	アルミニウム 合金鋳物 Aluminum Alloy Casting
	C ~ 0.25%	C 0.25 ~ 0.45%	C 0.45% ~	SCM	~35HRC	35 ~ 45HRC	FC	FCD	Cu	AC・ADC
PC(鋼用) for Steel	◎	◎	◎	○	○		○	○		
KC(鋳鉄用) for Cast Iron	○	○	○	○	○		◎	◎		
NC(非鉄用) for Non-ferrous Metal									○	◎

◎第一推奨材質 Best ○第二推奨材質 Good

■ヘッドの交換で1つのボディで複数の加工径に対応可能

A single cutter body applicable for multiple drilling diameters.

PXDボディ型番 PXD Body Designation	加工径 (mm) Drilling Dia.	
	最小 Min.	最大 Max.
PXDZ140-....	14	14.49
PXDZ145-....	14.5	14.99
PXDZ150-....	15	15.99
PXDZ160-....	16	16.99
PXDZ170-....	17	17.99
PXDZ180-....	18	18.99
PXDZ190-....	19	19.99
PXDZ200-....	20	20.99
PXDZ210-....	21	21.99
PXDZ220-....	22	22.99
PXDZ230-....	23	23.99
PXDZ240-....	24	24.99
PXDZ250-....	25	25.99

Phoenix

ヘッド交換式ドリル

Exchangeable Head Drill

PXDZ 3D/5D

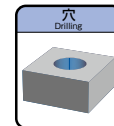

Specification

■形状寸法表 Specification

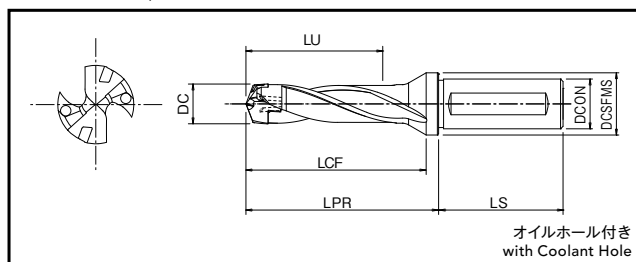

単位:mm Unit:mm

3Dタイプ 3D Type

ツールNo. EDP No.	呼び Designation	加工径 DC		有効加工 深さ LU	溝長 LCF	LPR	LS	シャンク径 DCON	DCSFMS	適用脱着 ドライバー Driver	適用 ヘッド Applicable Head	標準価格 (Yen)	
		最小 DCN	最大 DCX										
7831015	PXDZ140-3D-113.5-16	14	14.49	43	63.4	69.9	48	16	20	①	①	37,400	
7831016	PXDZ145-3D-115.5-16	14.5	14.99	44.5	65.5	72	48	16	20		②	37,400	
7831017	PXDZ150-3D-119.5-20	15	15.99	46.5	67.1	73.6	50	20	25		②	③	39,300
7831018	PXDZ160-3D-123.5-20	16	16.99	49.5	71.7	78.2	50	20	25			④	39,300
7831019	PXDZ170-3D-128.5-20	17	17.99	52.5	76.8	83.3	50	20	25			⑤	41,700
7831020	PXDZ180-3D-138.5-25	18	18.99	55.5	81.4	87.9	56	25	32			⑥	45,700
7831021	PXDZ190-3D-142.5-25	19	19.99	58.5	85.4	91.9	56	25	32	③		⑦	45,700
7831022	PXDZ200-3D-146.5-25	20	20.99	61.5	90.1	96.6	56	25	32		⑧	54,800	
7831023	PXDZ210-3D-154.5-32	21	21.99	64.5	94.7	101.2	60	32	42		⑨	54,800	
7831024	PXDZ220-3D-158.5-32	22	22.99	67.5	98.8	105.3	60	32	42		⑩	54,800	
7831025	PXDZ230-3D-162.5-32	23	23.99	70.5	103.4	109.9	60	32	42	④	⑪	60,400	
7831026	PXDZ240-3D-167.5-32	24	24.99	73.5	108.4	114.9	60	32	42		⑫	60,400	
7831027	PXDZ250-3D-170.5-32	25	25.99	76.5	112	118.5	60	32	42		⑬	67,500	

PXDZの呼びにボディ全長(ヘッド未装着時の長さ)を記載しております。

例) ツールNo : 7831015

呼び : PXDZ140-3D-113.5-16

↑ ボディ全長

PXDZ designation includes the total length of body (without head).

ex) EDP No. : 7831015

Designation : PXDZ140-3D-113.5-16

↑ total length of body

5Dタイプ 5D Type

単位:mm Unit:mm

ツールNo. EDP No.	呼び Designation	加工径 DC		有効加工 深さ LU	溝長 LCF	LPR	LS	シャンク径 DCON	DCSFMS	適用脱着 ドライバ Driver	適用 ヘッド Applicable Head	標準価格 (Yen)
		最小 DCN	最大 DCX									
7831065	PXDZ140-5D-141.5-16	14	14.49	71.2	92.9	97.9	48	16	20	①	①	44,900
7831066	PXDZ145-5D-144.5-16	14.5	14.99	73.7	96	101	48	16	20		②	44,900
7831067	PXDZ150-5D-149.5-20	15	15.99	77.5	97.1	103.6	50	20	25		③	47,100
7831068	PXDZ160-5D-155.5-20	16	16.99	82.5	103.7	110.2	50	20	25		④	47,100
7831069	PXDZ170-5D-162.5-20	17	17.99	87.5	110.8	117.3	50	20	25		⑤	49,800
7831070	PXDZ180-5D-174.5-25	18	18.99	92.5	117.4	123.9	56	25	32		⑥	54,800
7831071	PXDZ190-5D-180.5-25	19	19.99	97.5	123.4	129.9	56	25	32	②	⑦	54,800
7831072	PXDZ200-5D-186.5-25	20	20.99	102.5	130.1	136.6	56	25	32		⑧	66,100
7831073	PXDZ210-5D-196.5-32	21	21.99	107.5	136.7	143.2	60	32	42		⑨	66,100
7831074	PXDZ220-5D-202.5-32	22	22.99	112.5	142.8	149.3	60	32	42		⑩	66,100
7831075	PXDZ230-5D-208.5-32	23	23.99	117.5	149.4	155.9	60	32	42	③	⑪	72,500
7831076	PXDZ240-5D-215.5-32	24	24.99	122.5	156.4	162.9	60	32	42		⑫	72,500
7831077	PXDZ250-5D-220.5-32	25	25.99	127.5	162	168.5	60	32	42		⑬	81,000

PXDZの呼びにボディ全長(ヘッド未装着時の長さ)を記載しております。
例) ツールNo.: 7831015

呼び: PXDZ140-3D-113.5-16

↑ボディ全長

PXDZ designation includes the total length of body (without head).
ex) EDP No.: 7831015

Designation: PXDZ140-3D-113.5-16

↑total length of body

Accessories

■ 部品 Accessories

単位:mm Unit:mm

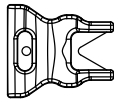
	ツールNo. EDP No.	呼び Designation	板厚 Sheet Thickness	適用ヘッド Applicable Head	標準価格 (Yen)	
 脱着ドライバ Driver	①	7808282	PXDP1400-1899	1.5	① ~ ⑥	2,360
	②	7808283	PXDP1900-2299	1.8	⑦ ~ ⑩	2,360
	③	7808284	PXDP2300-2699	2	⑪ ~ ⑬	2,410

脱着ドライバは別途ご購入下さい。 The drivers are sold separately from the cutters.

Phoenix

ヘッド交換式ドリル

Exchangeable Head Drill

PXDヘッド

Head

Heads

■適用ヘッド Heads

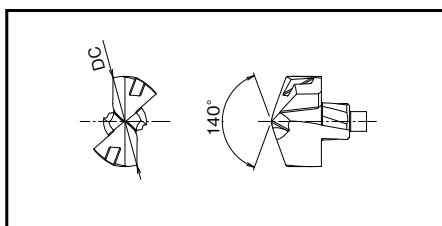

鋼用(PC) For steel (PC) 販売単価：1個 Sales price: per piece

単位:mm Unit:mm

ツールNo. EDP No.	呼び Designation	直径 DC	材種 Grades	在庫 Stock	標準価格 (Yen)
7831140	PXDH1400-PC	14	XP3425	C	8,640
	PXDH1410-PC	14.1	XP3425	※	—
	① PXDH1420-PC	14.2	XP3425	※	—
	PXDH1430-PC	14.3	XP3425	※	—
	PXDH1440-PC	14.4	XP3425	※	—
7831145	PXDH1450-PC	14.5	XP3425	C	8,640
	PXDH1460-PC	14.6	XP3425	※	—
	PXDH1470-PC	14.7	XP3425	※	—
	② PXDH1480-PC	14.8	XP3425	※	—
	PXDH1490-PC	14.9	XP3425	※	—
7831351	PXDH1495-PC	14.95	XP3425	C	8,640
7831150	PXDH1500-PC	15	XP3425	C	9,570
	PXDH1510-PC	15.1	XP3425	※	—
	PXDH1520-PC	15.2	XP3425	※	—
7831352	PXDH1525-PC	15.25	XP3425	C	9,570
	PXDH1530-PC	15.3	XP3425	※	—
	③ PXDH1540-PC	15.4	XP3425	※	—
7831155	PXDH1550-PC	15.5	XP3425	C	9,570
	PXDH1560-PC	15.6	XP3425	※	—
	PXDH1570-PC	15.7	XP3425	※	—
	PXDH1580-PC	15.8	XP3425	※	—
	PXDH1590-PC	15.9	XP3425	※	—
7831160	PXDH1600-PC	16	XP3425	C	9,570
	PXDH1610-PC	16.1	XP3425	※	—
	PXDH1620-PC	16.2	XP3425	※	—
	④ PXDH1630-PC	16.3	XP3425	※	—
	PXDH1640-PC	16.4	XP3425	※	—
7831165	PXDH1650-PC	16.5	XP3425	C	10,600
	PXDH1660-PC	16.6	XP3425	※	—
7831167	PXDH1670-PC	16.7	XP3425	C	10,600

ツールNo. EDP No.	呼び Designation	直径 DC	材種 Grades	在庫 Stock	標準価格 (Yen)
	PXDH1680-PC	16.8	XP3425	※	—
	④ PXDH1690-PC	16.9	XP3425	※	—
7831170	PXDH1700-PC	17	XP3425	C	10,600
	PXDH1710-PC	17.1	XP3425	※	—
	PXDH1720-PC	17.2	XP3425	※	—
7831353	PXDH1725-PC	17.25	XP3425	C	10,600
	PXDH1730-PC	17.3	XP3425	※	—
	⑤ PXDH1740-PC	17.4	XP3425	※	—
7831175	PXDH1750-PC	17.5	XP3425	C	11,500
	PXDH1760-PC	17.6	XP3425	※	—
	PXDH1770-PC	17.7	XP3425	※	—
	PXDH1780-PC	17.8	XP3425	※	—
	PXDH1790-PC	17.9	XP3425	※	—
7831180	PXDH1800-PC	18	XP3425	C	11,500
	PXDH1810-PC	18.1	XP3425	※	—
	PXDH1820-PC	18.2	XP3425	※	—
	PXDH1830-PC	18.3	XP3425	※	—
	PXDH1840-PC	18.4	XP3425	※	—
	⑥ PXDH1850-PC	18.5	XP3425	C	11,500
	PXDH1860-PC	18.6	XP3425	※	—
7831187	PXDH1870-PC	18.7	XP3425	C	11,500
	PXDH1880-PC	18.8	XP3425	※	—
	PXDH1890-PC	18.9	XP3425	※	—
7831190	PXDH1900-PC	19	XP3425	C	12,600
	PXDH1910-PC	19.1	XP3425	※	—
	PXDH1920-PC	19.2	XP3425	※	—
	⑦ PXDH1925-PC	19.25	XP3425	C	12,600
	PXDH1930-PC	19.3	XP3425	※	—
	PXDH1940-PC	19.4	XP3425	※	—
7831195	PXDH1950-PC	19.5	XP3425	C	12,600

FROM

単位:mm Unit:mm

ツールNo. EDP No.	呼び Designation	直径 DC	材種 Grades	在庫 Stock	標準価格 (Yen)
	PXDH1960-PC	19.6	XP3425	※	—
	PXDH1970-PC	19.7	XP3425	※	—
	PXDH1980-PC	19.8	XP3425	※	—
	PXDH1990-PC	19.9	XP3425	※	—
7831200	PXDH2000-PC	20	XP3425	C	13,700
	PXDH2010-PC	20.1	XP3425	※	—
	PXDH2020-PC	20.2	XP3425	※	—
	PXDH2030-PC	20.3	XP3425	※	—
	PXDH2040-PC	20.4	XP3425	※	—
7831205	PXDH2050-PC	20.5	XP3425	C	13,700
	PXDH2060-PC	20.6	XP3425	※	—
7831207	PXDH2070-PC	20.7	XP3425	C	13,700
	PXDH2080-PC	20.8	XP3425	※	—
	PXDH2090-PC	20.9	XP3425	※	—
7831210	PXDH2100-PC	21	XP3425	C	13,700
	PXDH2110-PC	21.1	XP3425	※	—
	PXDH2120-PC	21.2	XP3425	※	—
7831355	PXDH2125-PC	21.25	XP3425	C	13,700
	PXDH2130-PC	21.3	XP3425	※	—
	PXDH2140-PC	21.4	XP3425	※	—
7831215	PXDH2150-PC	21.5	XP3425	C	14,900
	PXDH2160-PC	21.6	XP3425	※	—
	PXDH2170-PC	21.7	XP3425	※	—
	PXDH2180-PC	21.8	XP3425	※	—
	PXDH2190-PC	21.9	XP3425	※	—
7831220	PXDH2200-PC	22	XP3425	C	14,900
	PXDH2210-PC	22.1	XP3425	※	—
	PXDH2220-PC	22.2	XP3425	※	—
	PXDH2230-PC	22.3	XP3425	※	—
7831224	PXDH2240-PC	22.4	XP3425	C	14,900
7831225	PXDH2250-PC	22.5	XP3425	C	14,900

ツールNo. EDP No.	呼び Designation	直径 DC	材種 Grades	在庫 Stock	標準価格 (Yen)
	PXDH2260-PC	22.6	XP3425	※	—
	PXDH2270-PC	22.7	XP3425	※	—
	PXDH2280-PC	22.8	XP3425	※	—
	PXDH2290-PC	22.9	XP3425	※	—
7831230	PXDH2300-PC	23	XP3425	C	16,200
	PXDH2310-PC	23.1	XP3425	※	—
	PXDH2320-PC	23.2	XP3425	※	—
7831356	PXDH2325-PC	23.25	XP3425	C	16,200
	PXDH2330-PC	23.3	XP3425	※	—
	PXDH2340-PC	23.4	XP3425	※	—
7831235	PXDH2350-PC	23.5	XP3425	C	16,200
	PXDH2360-PC	23.6	XP3425	※	—
	PXDH2370-PC	23.7	XP3425	※	—
	PXDH2380-PC	23.8	XP3425	※	—
	PXDH2390-PC	23.9	XP3425	※	—
7831240	PXDH2400-PC	24	XP3425	C	16,200
	PXDH2410-PC	24.1	XP3425	※	—
	PXDH2420-PC	24.2	XP3425	※	—
	PXDH2430-PC	24.3	XP3425	※	—
	PXDH2440-PC	24.4	XP3425	※	—
7831245	PXDH2450-PC	24.5	XP3425	C	16,200
	PXDH2460-PC	24.6	XP3425	※	—
	PXDH2470-PC	24.7	XP3425	※	—
	PXDH2480-PC	24.8	XP3425	※	—
	PXDH2490-PC	24.9	XP3425	※	—
7831250	PXDH2500-PC	25	XP3425	C	17,200
	PXDH2510-PC	25.1	XP3425	※	—
	PXDH2520-PC	25.2	XP3425	※	—
	PXDH2530-PC	25.3	XP3425	※	—
7831254	PXDH2540-PC	25.4	XP3425	C	18,100

青字 = 切削タップ下穴 Blue = pre-drilled hole for cutting taps
 赤字 = 転造タップ下穴 Red = pre-drilled hole for forming taps
 転造下穴として使用の場合は3Dタイプをご使用下さい。 For pre-drilled hole of forming tap, 3D type should be used. (5D is not recommended)

ねじの呼びに対応した推奨下穴径はp.15をご参照下さい。
 Please see p.15 for recommended pre-drilled hole size.

Phoenix

ヘッド交換式ドリル

Exchangeable Head Drill

PXDヘッド

Head

Heads

■適用ヘッド Heads

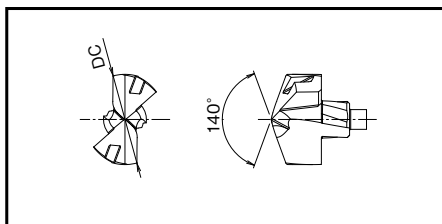

鋳鉄用(KC) For cast iron (KC) 販売単価：1個 Sales price: per piece

単位:mm Unit:mm

ツールNo. EDP No.	呼び Designation	直径 DC	材種 Grades	在庫 Stock	標準価格 (Yen)
7831440	PXDH1400-KC	14	XP1425	C	8,640
	PXDH1410-KC	14.1	XP1425	※	-
	① PXDH1420-KC	14.2	XP1425	※	-
	PXDH1430-KC	14.3	XP1425	※	-
	PXDH1440-KC	14.4	XP1425	※	-
7831445	PXDH1450-KC	14.5	XP1425	C	8,640
	PXDH1460-KC	14.6	XP1425	※	-
	② PXDH1470-KC	14.7	XP1425	※	-
	PXDH1480-KC	14.8	XP1425	※	-
	PXDH1490-KC	14.9	XP1425	※	-
7831450	PXDH1500-KC	15	XP1425	C	9,570
	PXDH1510-KC	15.1	XP1425	※	-
	PXDH1520-KC	15.2	XP1425	※	-
	PXDH1530-KC	15.3	XP1425	※	-
	③ PXDH1540-KC	15.4	XP1425	※	-
7831455	PXDH1550-KC	15.5	XP1425	C	9,570
	PXDH1560-KC	15.6	XP1425	※	-
	PXDH1570-KC	15.7	XP1425	※	-
	PXDH1580-KC	15.8	XP1425	※	-
	PXDH1590-KC	15.9	XP1425	※	-
7831460	PXDH1600-KC	16	XP1425	C	9,570
	PXDH1610-KC	16.1	XP1425	※	-
	PXDH1620-KC	16.2	XP1425	※	-
	PXDH1630-KC	16.3	XP1425	※	-
	PXDH1640-KC	16.4	XP1425	※	-
7831465	PXDH1650-KC	16.5	XP1425	C	10,600
	PXDH1660-KC	16.6	XP1425	※	-
7831467	PXDH1670-KC	16.7	XP1425	C	10,600
	PXDH1680-KC	16.8	XP1425	※	-
	PXDH1690-KC	16.9	XP1425	※	-

ツールNo. EDP No.	呼び Designation	直径 DC	材種 Grades	在庫 Stock	標準価格 (Yen)
7831470	PXDH1700-KC	17	XP1425	C	10,600
	PXDH1710-KC	17.1	XP1425	※	-
	PXDH1720-KC	17.2	XP1425	※	-
	PXDH1730-KC	17.3	XP1425	※	-
	PXDH1740-KC	17.4	XP1425	※	-
7831475	⑤ PXDH1750-KC	17.5	XP1425	C	11,500
	PXDH1760-KC	17.6	XP1425	※	-
	PXDH1770-KC	17.7	XP1425	※	-
	PXDH1780-KC	17.8	XP1425	※	-
	PXDH1790-KC	17.9	XP1425	※	-
7831480	PXDH1800-KC	18	XP1425	C	11,500
	PXDH1810-KC	18.1	XP1425	※	-
	PXDH1820-KC	18.2	XP1425	※	-
	PXDH1830-KC	18.3	XP1425	※	-
	⑥ PXDH1840-KC	18.4	XP1425	※	-
7831485	PXDH1850-KC	18.5	XP1425	C	11,500
	PXDH1860-KC	18.6	XP1425	※	-
7831487	PXDH1870-KC	18.7	XP1425	C	11,500
	PXDH1880-KC	18.8	XP1425	※	-
	PXDH1890-KC	18.9	XP1425	※	-
7831490	PXDH1900-KC	19	XP1425	C	12,600
	PXDH1910-KC	19.1	XP1425	※	-
	PXDH1920-KC	19.2	XP1425	※	-
	PXDH1930-KC	19.3	XP1425	※	-
	PXDH1940-KC	19.4	XP1425	※	-
7831495	⑦ PXDH1950-KC	19.5	XP1425	C	12,600
	PXDH1960-KC	19.6	XP1425	※	-
	PXDH1970-KC	19.7	XP1425	※	-
	PXDH1980-KC	19.8	XP1425	※	-
	PXDH1990-KC	19.9	XP1425	※	-

FROM

単位:mm Unit:mm

ツールNo. EDP No.	呼び Designation	直径 DC	材種 Grades	在庫 Stock	標準価格 (Yen)
7831500	PXDH2000-KC	20	XP1425	C	13,700
	PXDH2010-KC	20.1	XP1425	※	-
	PXDH2020-KC	20.2	XP1425	※	-
	PXDH2030-KC	20.3	XP1425	※	-
	PXDH2040-KC	20.4	XP1425	※	-
7831505	PXDH2050-KC	20.5	XP1425	C	13,700
	PXDH2060-KC	20.6	XP1425	※	-
7831507	PXDH2070-KC	20.7	XP1425	C	13,700
	PXDH2080-KC	20.8	XP1425	※	-
	PXDH2090-KC	20.9	XP1425	※	-
7831510	PXDH2100-KC	21	XP1425	C	13,700
	PXDH2110-KC	21.1	XP1425	※	-
	PXDH2120-KC	21.2	XP1425	※	-
	PXDH2130-KC	21.3	XP1425	※	-
	PXDH2140-KC	21.4	XP1425	※	-
7831515	PXDH2150-KC	21.5	XP1425	C	14,900
	PXDH2160-KC	21.6	XP1425	※	-
	PXDH2170-KC	21.7	XP1425	※	-
	PXDH2180-KC	21.8	XP1425	※	-
	PXDH2190-KC	21.9	XP1425	※	-
7831520	PXDH2200-KC	22	XP1425	C	14,900
	PXDH2210-KC	22.1	XP1425	※	-
	PXDH2220-KC	22.2	XP1425	※	-
	PXDH2230-KC	22.3	XP1425	※	-
7831524	PXDH2240-KC	22.4	XP1425	C	14,900
7831525	PXDH2250-KC	22.5	XP1425	C	14,900
	PXDH2260-KC	22.6	XP1425	※	-
	PXDH2270-KC	22.7	XP1425	※	-

ツールNo. EDP No.	呼び Designation	直径 DC	材種 Grades	在庫 Stock	標準価格 (Yen)
	PXDH2280-KC	22.8	XP1425	※	-
	PXDH2290-KC	22.9	XP1425	※	-
7831530	PXDH2300-KC	23	XP1425	C	16,200
	PXDH2310-KC	23.1	XP1425	※	-
	PXDH2320-KC	23.2	XP1425	※	-
	PXDH2330-KC	23.3	XP1425	※	-
	PXDH2340-KC	23.4	XP1425	※	-
7831535	PXDH2350-KC	23.5	XP1425	C	16,200
	PXDH2360-KC	23.6	XP1425	※	-
	PXDH2370-KC	23.7	XP1425	※	-
	PXDH2380-KC	23.8	XP1425	※	-
	PXDH2390-KC	23.9	XP1425	※	-
7831540	PXDH2400-KC	24	XP1425	C	16,200
	PXDH2410-KC	24.1	XP1425	※	-
	PXDH2420-KC	24.2	XP1425	※	-
	PXDH2430-KC	24.3	XP1425	※	-
	PXDH2440-KC	24.4	XP1425	※	-
7831545	PXDH2450-KC	24.5	XP1425	C	16,200
	PXDH2460-KC	24.6	XP1425	※	-
	PXDH2470-KC	24.7	XP1425	※	-
	PXDH2480-KC	24.8	XP1425	※	-
	PXDH2490-KC	24.9	XP1425	※	-
7831550	PXDH2500-KC	25	XP1425	C	17,200
	PXDH2510-KC	25.1	XP1425	※	-
	PXDH2520-KC	25.2	XP1425	※	-
	PXDH2530-KC	25.3	XP1425	※	-
7831554	PXDH2540-KC	25.4	XP1425	C	18,100

青字 = 切削タップ下穴 Blue = pre-drilled hole for cutting taps

ねじの呼びに対応した推奨下穴径はp.15をご参照下さい。

Please see p.15 for recommended pre-drilled hole size.

Phoenix

ヘッド交換式ドリル

Exchangeable Head Drill

PXDヘッド

Head

Heads

■適用ヘッド Heads

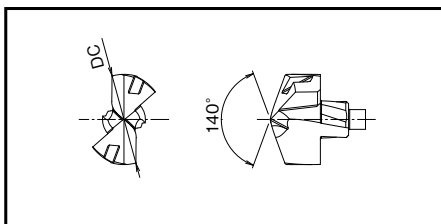

非鉄用(NC) For non-ferrous metal (NC) 販売単価: 1個 Sales price: per piece

単位:mm Unit:mm

ツールNo. EDP No.	呼び Designation	直径 DC	材種 Grades	在庫 Stock	標準価格 (Yen)
7831740	PXDH1400-NC	14	CF225	C	8,210
	PXDH1410-NC	14.1	CF225	※	-
	① PXDH1420-NC	14.2	CF225	※	-
	PXDH1430-NC	14.3	CF225	※	-
	PXDH1440-NC	14.4	CF225	※	-
7831745	PXDH1450-NC	14.5	CF225	C	8,210
	PXDH1460-NC	14.6	CF225	※	-
	② PXDH1470-NC	14.7	CF225	※	-
	PXDH1480-NC	14.8	CF225	※	-
	PXDH1490-NC	14.9	CF225	※	-
7831750	PXDH1500-NC	15	CF225	C	9,070
	PXDH1510-NC	15.1	CF225	※	-
	PXDH1520-NC	15.2	CF225	※	-
	PXDH1530-NC	15.3	CF225	※	-
	③ PXDH1540-NC	15.4	CF225	※	-
7831755	PXDH1550-NC	15.5	CF225	C	9,070
	PXDH1560-NC	15.6	CF225	※	-
	PXDH1570-NC	15.7	CF225	※	-
	PXDH1580-NC	15.8	CF225	※	-
	PXDH1590-NC	15.9	CF225	※	-
7831760	PXDH1600-NC	16	CF225	C	9,070
	PXDH1610-NC	16.1	CF225	※	-
	PXDH1620-NC	16.2	CF225	※	-
	PXDH1630-NC	16.3	CF225	※	-
	PXDH1640-NC	16.4	CF225	※	-
7831765	PXDH1650-NC	16.5	CF225	C	10,100
	PXDH1660-NC	16.6	CF225	※	-
7831767	PXDH1670-NC	16.7	CF225	C	10,100
	PXDH1680-NC	16.8	CF225	※	-
	PXDH1690-NC	16.9	CF225	※	-

ツールNo. EDP No.	呼び Designation	直径 DC	材種 Grades	在庫 Stock	標準価格 (Yen)
7831770	PXDH1700-NC	17	CF225	C	10,100
	PXDH1710-NC	17.1	CF225	※	-
	PXDH1720-NC	17.2	CF225	※	-
	PXDH1730-NC	17.3	CF225	※	-
	PXDH1740-NC	17.4	CF225	※	-
7831775	⑤ PXDH1750-NC	17.5	CF225	C	10,900
	PXDH1760-NC	17.6	CF225	※	-
	PXDH1770-NC	17.7	CF225	※	-
	PXDH1780-NC	17.8	CF225	※	-
	PXDH1790-NC	17.9	CF225	※	-
7831780	PXDH1800-NC	18	CF225	C	10,900
	PXDH1810-NC	18.1	CF225	※	-
	PXDH1820-NC	18.2	CF225	※	-
	PXDH1830-NC	18.3	CF225	※	-
	⑥ PXDH1840-NC	18.4	CF225	※	-
7831785	PXDH1850-NC	18.5	CF225	C	10,900
	PXDH1860-NC	18.6	CF225	※	-
7831787	PXDH1870-NC	18.7	CF225	C	10,900
	PXDH1880-NC	18.8	CF225	※	-
	PXDH1890-NC	18.9	CF225	※	-
7831790	PXDH1900-NC	19	CF225	C	11,900
	PXDH1910-NC	19.1	CF225	※	-
	PXDH1920-NC	19.2	CF225	※	-
	PXDH1930-NC	19.3	CF225	※	-
	PXDH1940-NC	19.4	CF225	※	-
7831795	⑦ PXDH1950-NC	19.5	CF225	C	11,900
	PXDH1960-NC	19.6	CF225	※	-
	PXDH1970-NC	19.7	CF225	※	-
	PXDH1980-NC	19.8	CF225	※	-
	PXDH1990-NC	19.9	CF225	※	-

FROM

ツールNo. EDP No.	呼び Designation	直径 DC	材種 Grades	在庫 Stock	標準価格 (Yen)
7831800	PXDH2000-NC	20	CF225	C	13,000
	PXDH2010-NC	20.1	CF225	※	-
	PXDH2020-NC	20.2	CF225	※	-
	PXDH2030-NC	20.3	CF225	※	-
	PXDH2040-NC	20.4	CF225	※	-
7831805	PXDH2050-NC	20.5	CF225	C	13,000
	PXDH2060-NC	20.6	CF225	※	-
7831807	PXDH2070-NC	20.7	CF225	C	13,000
	PXDH2080-NC	20.8	CF225	※	-
	PXDH2090-NC	20.9	CF225	※	-
7831810	PXDH2100-NC	21	CF225	C	13,000
	PXDH2110-NC	21.1	CF225	※	-
	PXDH2120-NC	21.2	CF225	※	-
	PXDH2130-NC	21.3	CF225	※	-
	PXDH2140-NC	21.4	CF225	※	-
7831815	PXDH2150-NC	21.5	CF225	C	14,200
	PXDH2160-NC	21.6	CF225	※	-
	PXDH2170-NC	21.7	CF225	※	-
	PXDH2180-NC	21.8	CF225	※	-
	PXDH2190-NC	21.9	CF225	※	-
7831820	PXDH2200-NC	22	CF225	C	14,200
	PXDH2210-NC	22.1	CF225	※	-
	PXDH2220-NC	22.2	CF225	※	-
	PXDH2230-NC	22.3	CF225	※	-
7831824	PXDH2240-NC	22.4	CF225	C	14,200
7831825	PXDH2250-NC	22.5	CF225	C	14,200
	PXDH2260-NC	22.6	CF225	※	-
	PXDH2270-NC	22.7	CF225	※	-

単位:mm Unit:mm

ツールNo. EDP No.	呼び Designation	直径 DC	材種 Grades	在庫 Stock	標準価格 (Yen)
	⑩ PXDH2280-NC	22.8	CF225	※	-
	PXDH2290-NC	22.9	CF225	※	-
7831830	PXDH2300-NC	23	CF225	C	15,500
	PXDH2310-NC	23.1	CF225	※	-
	PXDH2320-NC	23.2	CF225	※	-
	PXDH2330-NC	23.3	CF225	※	-
	PXDH2340-NC	23.4	CF225	※	-
7831835	⑪ PXDH2350-NC	23.5	CF225	C	15,500
	PXDH2360-NC	23.6	CF225	※	-
	PXDH2370-NC	23.7	CF225	※	-
	PXDH2380-NC	23.8	CF225	※	-
	PXDH2390-NC	23.9	CF225	※	-
7831840	PXDH2400-NC	24	CF225	C	15,500
	PXDH2410-NC	24.1	CF225	※	-
	PXDH2420-NC	24.2	CF225	※	-
	PXDH2430-NC	24.3	CF225	※	-
	PXDH2440-NC	24.4	CF225	※	-
7831845	⑫ PXDH2450-NC	24.5	CF225	C	15,500
	PXDH2460-NC	24.6	CF225	※	-
	PXDH2470-NC	24.7	CF225	※	-
	PXDH2480-NC	24.8	CF225	※	-
	PXDH2490-NC	24.9	CF225	※	-
7831850	PXDH2500-NC	25	CF225	C	16,300
	PXDH2510-NC	25.1	CF225	※	-
	⑬ PXDH2520-NC	25.2	CF225	※	-
	PXDH2530-NC	25.3	CF225	※	-
7831854	PXDH2540-NC	25.4	CF225	C	17,200

青字 = 切削タップ下穴 Blue = pre-drilled hole for cutting taps

ねじの呼びに対応した推奨下穴径はp.15をご参照下さい。
 Please see p.15 for recommended pre-drilled hole size.

Cutting Conditions

■切削条件基準表 Cutting Conditions

被削材 Work Material	PC(鋼用) For Steel						KC(鋳鉄用) For Cast Iron				NC(非鉄用) For Non-ferrous Metal	
	軟鋼・低炭素鋼 Mild Steel・ Low Carbon Steel SS400, S10C ~150HB (~500N/mm ²)		炭素鋼 Carbon Steel S35C, S50C ~210HB (~710N/mm ²)		合金鋼 Alloy Steel SCM, SCr, SNCM 16 ~ 30HRC (710 ~ 950N/mm ²)		鋳鉄 Cast Iron FC250 (~350N/mm ²)		ダクタイル鋳鉄 Ductile Cast Iron FCD450, FCD600 (400 ~ 600N/mm ²)		アルミニウム合金鋳物 Aluminum Alloy Casting AC4A, ADC	
切削速度 Cutting Speed	80~120m/min		80~120m/min		60~120m/min		80~120m/min		60~100m/min		80~180m/min	
直径 Drill Dia. (mm)	回転速度 Speed (min ⁻¹)	送り量 Feed Rate (mm/rev)	回転速度 Speed (min ⁻¹)	送り量 Feed Rate (mm/rev)	回転速度 Speed (min ⁻¹)	送り量 Feed Rate (mm/rev)	回転速度 Speed (min ⁻¹)	送り量 Feed Rate (mm/rev)	回転速度 Speed (min ⁻¹)	送り量 Feed Rate (mm/rev)	回転速度 Speed (min ⁻¹)	送り量 Feed Rate (mm/rev)
14	2,300	0.21 ~ 0.35	2,300	0.21 ~ 0.35	2,000	0.21 ~ 0.35	2,300	0.21 ~ 0.35	1,800	0.21 ~ 0.35	3,000	0.28 ~ 0.42
15	2,100	0.23 ~ 0.38	2,100	0.23 ~ 0.38	1,900	0.23 ~ 0.38	2,100	0.23 ~ 0.38	1,700	0.23 ~ 0.38	2,800	0.3 ~ 0.45
16	2,000	0.24 ~ 0.4	2,000	0.24 ~ 0.4	1,800	0.24 ~ 0.4	2,000	0.24 ~ 0.4	1,600	0.24 ~ 0.4	2,600	0.32 ~ 0.48
17	1,900	0.26 ~ 0.43	1,900	0.26 ~ 0.43	1,700	0.26 ~ 0.43	1,900	0.26 ~ 0.43	1,500	0.26 ~ 0.43	2,400	0.34 ~ 0.51
18	1,800	0.27 ~ 0.45	1,800	0.27 ~ 0.45	1,600	0.27 ~ 0.45	1,800	0.27 ~ 0.45	1,400	0.27 ~ 0.45	2,300	0.36 ~ 0.54
19	1,700	0.29 ~ 0.48	1,700	0.29 ~ 0.48	1,500	0.29 ~ 0.48	1,700	0.29 ~ 0.48	1,300	0.29 ~ 0.48	2,200	0.38 ~ 0.57
20	1,600	0.3 ~ 0.5	1,600	0.3 ~ 0.5	1,400	0.3 ~ 0.5	1,600	0.3 ~ 0.5	1,300	0.3 ~ 0.5	2,100	0.4 ~ 0.6
21	1,500	0.32 ~ 0.53	1,500	0.32 ~ 0.53	1,400	0.32 ~ 0.53	1,500	0.32 ~ 0.53	1,200	0.32 ~ 0.53	2,000	0.42 ~ 0.63
22	1,400	0.33 ~ 0.55	1,400	0.33 ~ 0.55	1,300	0.33 ~ 0.55	1,400	0.33 ~ 0.55	1,200	0.33 ~ 0.55	1,900	0.44 ~ 0.66
23	1,400	0.35 ~ 0.58	1,400	0.35 ~ 0.58	1,200	0.35 ~ 0.58	1,400	0.35 ~ 0.58	1,100	0.35 ~ 0.58	1,800	0.46 ~ 0.69
24	1,300	0.36 ~ 0.6	1,300	0.36 ~ 0.6	1,200	0.36 ~ 0.6	1,300	0.36 ~ 0.6	1,100	0.36 ~ 0.6	1,700	0.48 ~ 0.72
25	1,300	0.38 ~ 0.63	1,300	0.38 ~ 0.63	1,100	0.38 ~ 0.63	1,300	0.38 ~ 0.63	1,000	0.38 ~ 0.63	1,700	0.5 ~ 0.75

- この切削条件基準表は、水溶性切削油剤を内部給油にて使用する場合があります。
- 水溶性切削油剤は希釈倍率20倍以下の良質のものをご使用下さい。
- この切削条件基準表は、実切削速度における一般的な値を示したものです。加工環境に合わせて適宜調整して下さい。
- 被削材の保持はしっかりと行い、変形、たわみ、振動が起こらない状態にして下さい。
- オイルホールの詰まりは折損トラブルの原因になります。給油装置のフィルタは必ず装着して下さい。
- ヘッドの取り付け方や使用上の注意についてはp.28をご参照下さい。
- The indicated speeds and feeds are for using water-soluble oil with inner supply.
- Suitable cutting fluid is water-soluble in high density (less than 20 times dilution).
- The above cutting conditions are to be used as general guidelines. Adjustments may be necessary depending on actual cutting condition.
- Fasten the work material to reduce the possibility of work deformation, deflection of machined surface, or vibration.
- A clogged oil hole can lead to a breakage. Make sure that a filter is attached to the oil feeder.
- Please see p.28 for mounting procedure and precaution for machining.

■ ヘッド交換式ドリルの取り付けについて Mounting Procedure

■ 取り付け手順 Procedure



ステップ1 Step 1
締結部の汚れをエアブローなどで除去して下さい。
Clean attachment area with an air blower.

※切りくずなどが残っていると、正しい締結ができずヘッドが破損する恐れがあります。
Any leftover cutting chips may prevent the head from being mounted properly and may cause damages to the tool.



ステップ2 Step 2
ヘッドを手で締結部へ装着します。
Attach the head manually.



ステップ3 Step 3
専用ドライバの金属板部をヘッドの溝へ差し込みます。
Insert the flat metal portion of the designated driver into the groove of the head.

※溝の奥まで専用ドライバをしっかりと差し込んで下さい。専用ドライバの差し込みが浅い場合、溝部が破損する恐れがあります。
Insert the designated driver firmly into the groove. If the insertion of the designated driver is shallow, it could damage the flutes.



ステップ4 Step 4
専用ドライバをボディ側に押しつけながら時計回りに回転し、ヘッドをボディへ締結します。
Turn the designated driver clockwise and mount the head onto the body.

※ヘッドとボディの締結部に隙間が無いようにしっかりと締結下さい。
Mount head firmly and make sure that there is no gap between the head and the body.

■ 取り付け後の確認 After mounting



取り付け完了後、隙間(シクネス)ゲージ(20µm)にて矢印部位(青、赤)の隙間確認を行って下さい。
Make sure no clearance gap is found at places marked blue and red by using thickness gauges of 20µm.



このように取り付け後隙間が発生した場合は締結部の汚れをエアブローなどで除去し、再度取り付け・確認を行って下さい。
If clearance gap is found, please mount and check again after cleaning the mounting area by air blow.

※ボディは拘束力が一定以下になると寿命となります。隙間が発生したり、ヘッドが手で抜けるようになると寿命です。
If the clearance gap still remains or head can be took off without driver, body must be changed.

■ 使用上の注意 Precaution

■ PXDはクランプねじを使用しないため、締結部が緩みにくい加工環境を設定する必要があります。
The machining environment that won't loosen the mounting area is essential for PXD because no clamping screws are used.

特に穴あけ貫通時には注意が必要となります。
Extra caution is necessary for through holes.

- ・薄板でワーク保持が悪く、スプリングバックを起こしやすい材料での加工は、抜け際の回転送りを30%程度落として下さい。
- ・貫通する時の深さ位置の設定は右記を参考にして下さい。
- ・ Reduce feed rate by 30% when pulling the drill out from the hole of thin plate without enough holding or material tend to spring back easily.
- ・ Please refer photos on right for setting of through holes.

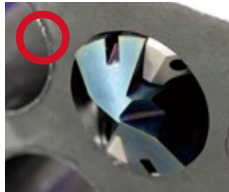

貫通する時の深さ位置はドリル肩部より2mm以下に設定して下さい。
Head should be penetrated no more than 2mm from the shoulder of PXD.



Phoenix

ヘッド交換式ドリル

Exchangeable Head Drill

PXD

■これまでの加工をスピードアップ! Achieves faster feeds than ever before!

加工能率2倍以上! Double the efficiency!

	工具径 Drill Dia.	被削材 Work Material	穴深さ Depth of Hole	切削速度 Cutting Speed (m/min)	回転数 Speed (min ⁻¹)	送り量 Feed Rate (mm/rev)	送り速度 Feed (mm/min)	切削油剤 Coolant	使用機械 Machine
油穴付きハイスドリル HSS Drill with Oil Hole	φ16	S50C	50mm	30	600	0.4	240	水溶性 切削油剤 Water-Soluble	横形マシニング センタ Horizontal Machining Center
インデキサブルドリル Indexable Drill				160	3,200	0.09	288		
PXD				100	1,990	0.3	597		

加工能率3倍以上! Triple the efficiency!

	工具径 Drill Dia.	被削材 Work Material	穴深さ Depth of Hole	切削速度 Cutting Speed (m/min)	回転数 Speed (min ⁻¹)	送り量 Feed Rate (mm/rev)	送り速度 Feed (mm/min)	切削油剤 Coolant	使用機械 Machine
油穴付きハイスドリル HSS Drill with Oil Hole	φ25	S50C	75mm	25	320	0.5	160	水溶性 切削油剤 Water-Soluble	横形マシニング センタ Horizontal Machining Center
インデキサブルドリル Indexable Drill				160	2,000	0.13	260		
PXD				100	1,270	0.5	635		

■加工能率・寿命アップ! 加工コスト大幅ダウン!

Greater tool life and efficiency while significantly lowering cost!

工具径: φ16

Drill Diameter

使用機械: 横形マシニングセンタ
Machine Horizontal Machining Center

穴深さ: 50mm

Depth of Hole

切削油剤: 水溶性切削油剤
Coolant Water-Soluble

被削材 Work Material	SS400		S50C	
	切削速度 Cutting Speed (m/min)	送り量 Feed Rate (mm/rev)	切削速度 Cutting Speed (m/min)	送り量 Feed Rate (mm/rev)
PXD	100	0.3	100	0.3
他社インデキサブルドリル Competitor's Indexable Drill	200	0.1	160	0.1
他社ハイスドリル Competitor's HSS Drill	30	0.3	30	0.3

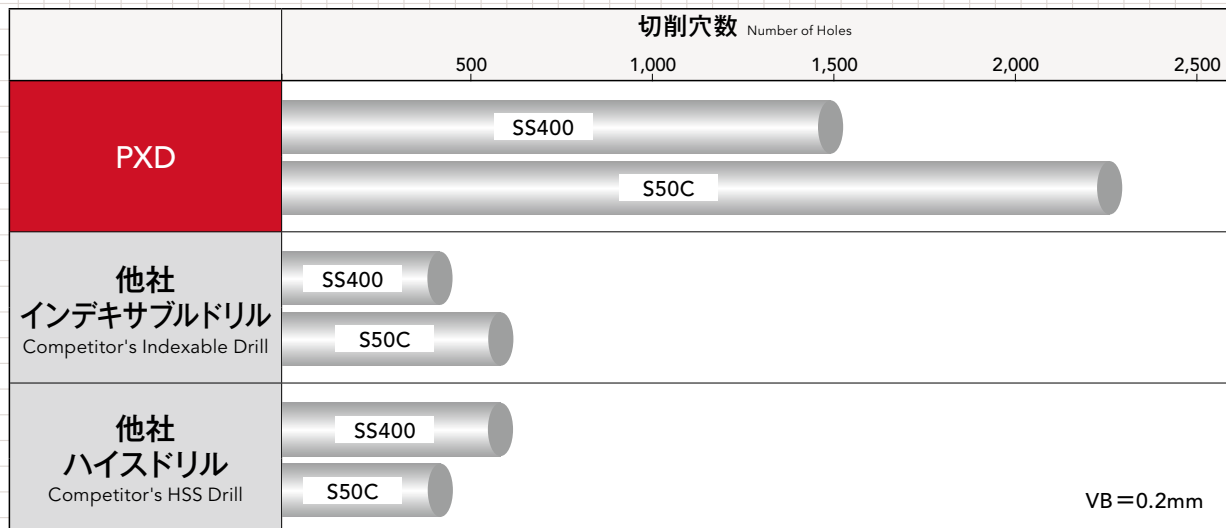

Cutting Data

加工データ Cutting Data

転造タップの下穴用にはPXD 3D！ PXD 3D drill adequate pre-drilled holes for forming taps

穴あけ Drilling

使用工具 Tool	PXDZ220-3D-158.5-32 (φ22.4)
使用ヘッド(材種) Head (grade)	PXDH2240-PC
被削材 Work Material	S50C
切削速度 Cutting Speed	70m/min (995min ⁻¹)
送り速度 Feed	597mm/min (0.6mm/rev)
穴深さ Depth of Hole	112mm (止り) (Blind)
切削油剤 Coolant	水溶性切削油剤 Water-Soluble
使用機械 Machine	横形マシニングセンタ Horizontal Machining Center

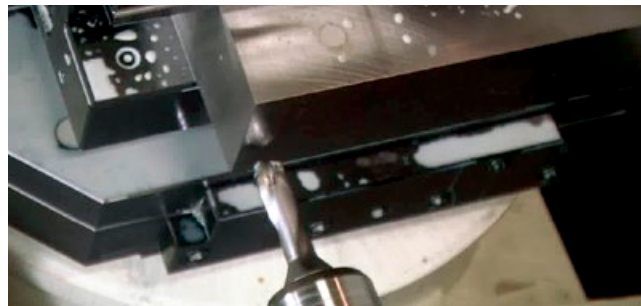

タッピング Tapping

使用工具 Tool	転造タップ S-XPf M24×3 Forming Tap
被削材 Work Material	S50C
ねじ立て長さ Tapping Length	48mm (2D) (止り) (Blind)
切削速度 Cutting Speed	15m/min (199min ⁻¹)
切削油剤 Coolant	水溶性切削油剤 Water-Soluble
使用機械 Machine	横形マシニングセンタ Horizontal Machining Center



※転造タップ用下穴加工にはPXD 3Dをご使用下さい。
For pre-drilled hole of forming tap, 3D type should be used (5D is not recommended).

SS400の長寿命加工 Long tool life in SS400

使用工具 Tool	PXDZ160-3D-123.5-20 (φ16)
使用ヘッド(材種) Head (grade)	PXDH1600-PC
被削材 Work Material	SS400
切削速度 Cutting Speed	100m/min (1,990min ⁻¹)
送り速度 Feed	597mm/min (0.3mm/rev)
穴深さ Depth of Hole	45mm (通り) (Through)
切削油剤 Coolant	水溶性切削油剤 Water-Soluble
使用機械 Machine	横形マシニングセンタ Horizontal Machining Center

	切削穴数 Number of Holes		
	500	1,000	1,500
PXD			
従来超硬ドリル Conventional Carbide Drill			

大径の加工において、加工環境によっては、超硬ソリッドドリル以上の耐久性がでる場合がある。上手に超硬ソリッドドリルとヘッド交換式ドリルを使い分けることで、低コストな加工が可能である。

Higher durability may be achieved than conventional carbide drills depending on the working environment. Optimal, low-cost drilling is possible by properly selected carbide solid drills and exchangeable head drills.

Cutting Data

加工データ Cutting Data

SS400の長寿命加工 Long tool life in SS400

使用工具 Tool	PXDZ160-3D-123.5-20 (φ16)	
使用ヘッド(材種) Head (grade)	PXDH1600-PC	
被削材 Work Material	SS400	
切削速度 Cutting Speed	100m/min (1,990min ⁻¹)	
送り速度 Feed	597mm/min (0.3mm/rev)	
穴深さ Depth of Hole	45mm (通り) (Through)	
切削油剤 Coolant	水溶性切削油剤 Water-Soluble	
使用機械 Machine	横形マシニングセンタ Horizontal Machining Center	

SS400において、摩耗・溶着の進行が抑えられ、他社品に比べ約1.8倍長寿命であった。

In SS400, the progress of wear and welding was suppressed, and the tool life was about 1.8 times longer than the competitor product.

	切削穴数 Number of Holes		
	500	1,000	1,500
PXD			
他社品 A Competitor			
他社品 B Competitor			

900穴加工時の摩耗比較 Wear comparison after 900 holes of drilling



専用ヘッドによる鋳物加工 Exchangeable head for cast iron

使用工具 Tool	PXDZ160-3D-123.5-20 (φ16)	
使用ヘッド(材種) Head (grade)	PXDH1600-KC	
被削材 Work Material	FC250	FCD600
切削速度 Cutting Speed	100m/min (1,990min ⁻¹)	80m/min (1,600min ⁻¹)
送り速度 Feed	796mm/min (0.4mm/rev)	480mm/min (0.3mm/rev)
穴深さ Depth of Hole	45mm (通り) (Through)	
切削油剤 Coolant	水溶性切削油剤 Water-Soluble	
使用機械 Machine	横形マシニングセンタ Horizontal Machining Center	

鋳鉄専用ヘッドを使用することにより長寿命を実現することができた。

This exchangeable head is designated for cast iron and can maintain long tool life.

【FC250】1,280穴加工時の摩耗比較 Wear comparison after 1,280 holes of drilling

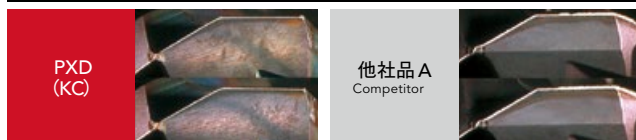

	切削穴数 Number of Holes		
	500	1,000	1,500
PXD			
他社品 A Competitor			
他社品 B Competitor			

【FCD600】1,600穴加工時の摩耗比較 Wear comparison after 1,600 holes of drilling



φ20の高効率加工 Highly efficient drilling at φ20

使用工具 Tool	PXDZ200-3D-146.5-25 (φ20)	
使用ヘッド(材種) Head (grade)	PXDH2000-PC	
被削材 Work Material	S50C	
切削速度 Cutting Speed	100m/min (1,590min ⁻¹)	
送り速度 Feed	637mm/min (0.4mm/rev)	
穴深さ Depth of Hole	50mm (通り) (Through)	
切削油剤 Coolant	水溶性切削油剤 Water-Soluble	
使用機械 Machine	横形マシニングセンタ Horizontal Machining Center	

φ20の穴あけにおいて高効率かつ工具の長寿命化を実現した。

Long tool life and highly efficient drilling at φ20.

	切削穴数 Number of Holes		
	500	1,000	1,500
PXD			
他社品 A Competitor			
他社品 B Competitor			

1,000穴加工時の摩耗比較 Wear comparison after 1,000 holes of drilling



S50Cの高効率加工(穴深さ5D) Highly efficient drilling in S50C (drilling depth 5xD)

使用工具 Tool	PXDZ160-5D-155.5-20 (φ16)
使用ヘッド(材種) Head (grade)	PXDH1600-PC
被削材 Work Material	S50C
切削速度 Cutting Speed	100m/min (1,990min ⁻¹)
送り速度 Feed	597mm/min (0.3mm/rev)
穴深さ Depth of Hole	80mm (止り) (Blind)
切削油剤 Coolant	水溶性切削油剤 Water-Soluble
使用機械 Machine	横形マシニングセンタ Horizontal Machining Center

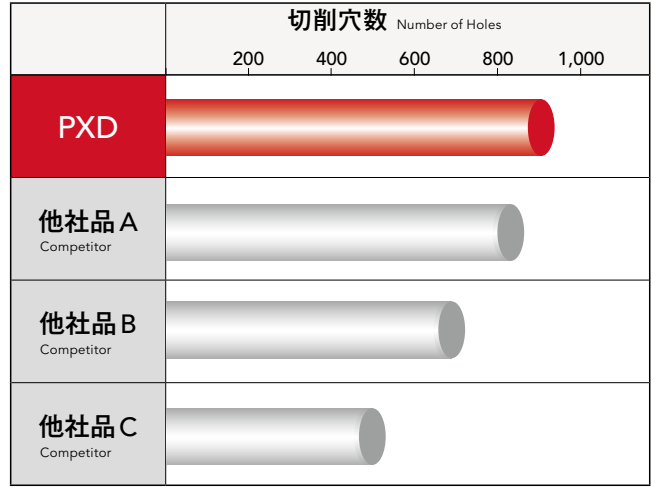

5Dの深穴加工でも超硬ドリルと同等の加工能率を実現した。また、他社品に比べても長寿命であった。Even when drilling hole depth of 5xD, the PXD achieved at the same level of efficiency as a carbide drill. Moreover, it had the best tool life versus the competitions.



■座ぐり付き、面取り付き等、加工に合わせた特殊品も承っております。詳細は当社営業までお問い合わせ下さい。
 Custom tooling with specifications such as counterboring and chamfering are available upon request. Please contact your local sales representative for details.

座ぐり刃付きPXDドリル(特殊品)
PXD Drill with Counterbore (Special)

面取り刃付きPXDドリル(特殊品)
PXD Drill with Chamfer (Special)

» Phoenix PD

インデキサブルドリル
Indexable Drill

Phoenix Drill

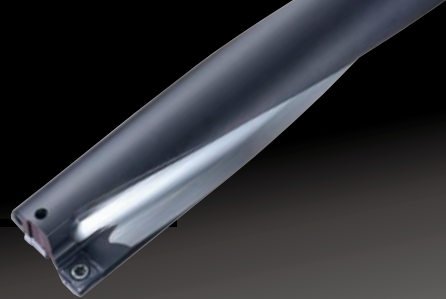

■ 特長 Features

剛性を高める溝設計に高精度仕上げをプラスすることで
切りくず排出性をさらにアップ! PAT. in Japan

High precision finishing on flute improves rigidity, chip ejection and reduces cutting force!

ボディ先端のガイド溝
がスムーズな切りくず
排出を実現

Optimized groove on the body
tip helps to lead chips to the flute
smoothly.



内部給油により
高能率加工が可能

The internal coolant system
enables highly efficient drilling.

インサートの配列バランスを
最適化し、高送り条件を実現

High feed drilling is possible by sequential
balance of inserts.

外周・中心に同一インサートを使用する4コーナ仕様で、
経済的かつ、工具管理が容易 (XCMT03...は2コーナ仕様)

Economical 4-corner insert design maximizes cost efficiency, with the same insert applicable
to both center and peripheral cutting edge. (XCMT03: 2-corner insert)



さらなる耐久性を求める加工には外周刃に専用インサートを!

The peripheral insert is recommended for maximum durability!



■幅広い被削材に対応可能なラインナップ

Broad lineup to accommodate a wide range of materials

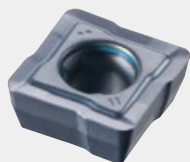

鋼・ステンレス鋼用(DM)

for Steel and Stainless Steel

XP9020

- 切れ味と強度をバランスよく兼ね備えた形状
- 鋼、ステンレス鋼加工において優れた性能を発揮
- Well balanced insert with sharpness and rigidity
- Optimal for steel and stainless steels

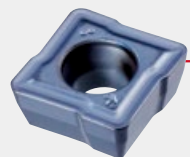

鋳鉄用(DR)

for Cast Iron

XP1010

- すくい角とランドによる刃先強度に優れた形状
- 鋳鉄加工において優れた性能を発揮
- Strong cutting edge acquired by rake angle and land
- Optimal for cast iron



アルミニウム合金・非鉄用(DN)

for Aluminum Alloy and Non-ferrous Metal

CK110

- シャープな切れ刃とポリッシュ処理による切りくず排出性に優れた形状
- アルミニウム合金・非鉄加工において優れた性能を発揮
- Excellent chip evacuation is acquired by sharp cutting edges and polishing treatment
- Optimal for aluminum alloy and non-ferrous metal

■さらなる耐久性を求める加工には外周刃に専用インサートを!

The peripheral insert is recommended for maximum durability!

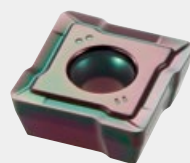

外周刃専用インサート(DM)

Inserts for Peripheral Cutting Edge

XC9015

- 強靱な超硬母材と厚膜のCVDコーティングにより、耐摩耗性に優れる
- 鋼、鋳鉄加工において優れた性能を発揮
- Excellent abrasion resistance with the robust carbide base metal and thick layered CVD coating
- Excellent performance in steel and cast iron applications



■旋削荒取り加工も可能

Rough process of turning is also possible

■内径旋削加工

Turning internal diameter

ワーク正回転
(ドリル=固定)

Normal rotation
(Drill=Fixed)

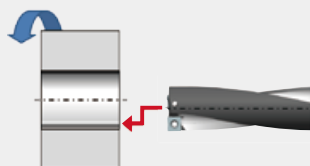

■外径旋削加工

Turning outer diameter

ワーク逆回転
(ドリル=固定)

Reverse rotation
(Drill=Fixed)

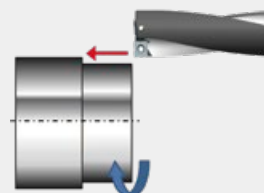

Phoenix

インデキサブルドリル

Indexable Drill

P2D

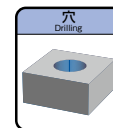

Specification

■形状寸法表 Specification

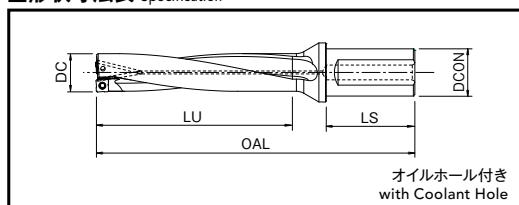

■加工径最大調整量 Max Offset Amount of Effective Dia.

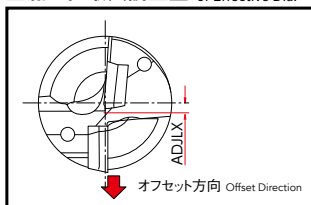

単位:mm Unit:mm

ツールNo. EDP No.	呼び Designation	外径 DC	全長 OAL	有効加工深さ LU	シャンク径 DCON	シャンク長 LS	最大 オフセット量 ADJLX	最大 加工径 DCX	適用インサート Applicable Inserts	標準価格 (Yen)
7803180	P2D1200FS20M03	12	87	24	20	50	0.4	12.8	①	41,700
7803181	P2D1250FS20M03	12.5	88	25	20	50	0.4	13.3		41,700
7803182	P2D1300FS20M03	13	89	26	20	50	0.3	13.6		41,700
7803183	P2D1350FS20M03	13.5	90	27	20	50	0.2	13.9		41,700
7803184	P2D1400FS20M03	14	91	28	20	50	0.2	14.4		41,700
7803185	P2D1450FS20M03	14.5	92	29	20	50	0.1	14.7	41,700	
7803117	P2D1500FS20M04	15	95	30	20	50	0.4	15.8	②	41,700
7803118	P2D1550FS20M04	15.5	96	31	20	50	0.3	16.1		41,700
7803119	P2D1600FS20M04	16	97	32	20	50	0.3	16.6		41,700
7803120	P2D1650FS20M04	16.5	98	33	20	50	0.3	17.1		41,700
7803121	P2D1700FS20M05	17	102	34	20	50	0.6	18.2	③	41,700
7803122	P2D1750FS20M05	17.5	103	35	20	50	0.5	18.5		41,700
7803190	P2D1750FS25M05		109		25	56		41,700		
7803123	P2D1800FS25M05	18	110	36	25	56	0.5	19.0		41,700
7803124	P2D1850FS25M05	18.5	111	37	25	56	0.4	19.3		41,700
7803125	P2D1900FS25M06	19	112	38	25	56	0.6	20.2	④	41,700
7803126	P2D1950FS25M06	19.5	113	39	25	56	0.5	20.5		41,700
7803127	P2D2000FS25M06	20	114	40	25	56	0.4	20.8		41,700
7803128	P2D2050FS25M06	20.5	115	41	25	56	0.4	21.3		41,700
7803129	P2D2100FS25M07	21	121	42	25	56	0.6	22.2		41,700
7803130	P2D2150FS25M07	21.5	122	43	25	56	0.6	22.7	⑤	41,700
7803131	P2D2200FS25M07	22	123	44	25	56	0.5	23.0		41,700
7803132	P2D2250FS25M07	22.5	124	45	25	56	0.5	23.5		41,700
7803133	P2D2300FS25M07	23	125	46	25	56	0.4	23.8		41,700
7803191	P2D2350FS25M07	23.5	126	47	25	56	0.3	24.1		41,700
7803134	P2D2350FS32M07		130		32	60		41,700		
7803192	P2D2400FS25M07	24	127	48	25	56	0.3	24.6		41,700
7803135	P2D2400FS32M07		131		32	60		41,700		
7803193	P2D2450FS25M07	24.5	128	49	25	56	0.2	24.9		41,700
7803136	P2D2450FS32M07		132		32	60		41,700		

FROM

単位:mm Unit:mm

ツールNo. EDP No.	呼び Designation	外径 DC	全長 OAL	有効加工深さ LU	シャンク径 DCON	シャンク長 LS	最大 オフセット量 ADJLX	最大 加工径 DCX	適用インサート Applicable Inserts	標準価格 (Yen)	
7803194	P2D2500FS25M08	25	129	50	25	56	0.7	26.4	⑥	46,300	
7803137	P2D2500FS32M08		133		32	60				46,300	
7803195	P2D2550FS25M08	25.5	130	51	25	56	0.6	26.7		46,300	
7803138	P2D2550FS32M08		134		32	60				46,300	
7803139	P2D2600FS32M08	26	135	52	32	60	0.5	27.0		46,300	
7803140	P2D2650FS32M08	26.5	136	53	32	60	0.5	27.5		46,300	
7803141	P2D2700FS32M08	27	137	54	32	60	0.4	27.8		46,300	
7803142	P2D2800FS32M08	28	139	56	32	60	0.3	28.6		46,300	
7803143	P2D2850FS32M08	28.5	140	57	32	60	0.2	28.9		46,300	
7803144	P2D2900FS32M09	29	141	58	32	60	0.8	30.6		⑦	54,300
7803145	P2D3000FS32M09	30	143	60	32	60	0.7	31.4	54,300		
7803146	P2D3100FS32M09	31	145	62	32	60	0.6	32.2	54,300		
7803196	P2D3100FS40M09		155		40	70			54,300		
7803147	P2D3200FS32M09	32	147	64	32	60	0.5	33.0	54,300		
7803197	P2D3200FS40M09		157		40	70			54,300		
7803148	P2D3300FS40M09	33	159	66	40	70	0.4	33.8	54,300		
7803149	P2D3350FS40M09	33.5	160	67	40	70	0.2	33.9	54,300		
7803150	P2D3400FS40M10	34	161	68	40	70	1.1	36.2	⑧		60,000
7803151	P2D3500FS40M10	35	163	70	40	70	0.8	36.6			60,000
7803152	P2D3600FS40M10	36	165	72	40	70	0.8	37.6		60,000	
7803153	P2D3700FS40M10	37	167	74	40	70	0.6	38.2		60,000	
7803154	P2D3800FS40M10	38	169	76	40	70	0.3	38.6		60,000	
7803155	P2D3900FS40M12	39	178	78	40	70	1.0	41.0		⑨	68,200
7803156	P2D4000FS40M12	40	180	80	40	70	0.9	41.8	68,200		
7803157	P2D4100FS40M12	41	182	82	40	70	0.8	42.6	68,200		
7803158	P2D4200FS40M12	42	184	84	40	70	0.6	43.2	68,200		
7803159	P2D4300FS40M12	43	186	86	40	70	0.5	44.0	68,200		
7803160	P2D4400FS40M12	44	188	88	40	70	0.3	44.6	68,200		
7803161	P2D4500FS40M13	45	190	90	40	70	0.9	46.8	⑩	81,800	
7803162	P2D4600FS40M13	46	192	92	40	70	0.8	47.6		81,800	
7803163	P2D4700FS40M13	47	194	94	40	70	0.7	48.4		81,800	
7803164	P2D4800FS40M13	48	196	96	40	70	0.5	49.0		81,800	
7803165	P2D4900FS40M13	49	198	98	40	70	0.3	49.6		81,800	
7803166	P2D5000FS40M14	50	200	100	40	70	1.1	52.2		⑪	90,500
7803167	P2D5100FS40M14	51	202	102	40	70	1.0	53.0	90,500		
7803168	P2D5200FS40M14	52	204	104	40	70	0.8	53.6	90,500		
7803169	P2D5300FS40M14	53	206	106	40	70	0.7	54.4	90,500		
7803170	P2D5400FS40M14	54	208	108	40	70	0.6	55.2	90,500		
7803171	P2D5500FS40M14	55	210	110	40	70	0.4	55.8	90,500		
7803172	P2D5600FS40M14	56	212	112	40	70	0.1	56.2	90,500		
7803173	P2D5700FS40M16	57	214	114	40	70	1.1	59.2	⑫	118,000	
7803174	P2D5800FS40M16	58	216	116	40	70	1.0	60.0		118,000	
7803175	P2D5900FS40M16	59	218	118	40	70	0.9	60.8		118,000	
7803176	P2D6000FS40M16	60	220	120	40	70	0.8	61.6		118,000	
7803177	P2D6100FS40M16	61	222	122	40	70	0.6	62.2		118,000	
7803178	P2D6200FS40M16	62	224	124	40	70	0.4	62.8		118,000	
7803179	P2D6300FS40M16	63	226	126	40	70	0.2	63.4	118,000		

青字 = 切削タップ下穴 Blue = pre-drilled hole for cutting taps
 ねじの呼びに対応した推奨下穴径はp.16をご参照下さい。
 Please see p.16 for recommended pre-drilled hole size.

在庫区分は全てC(標準在庫品)となります。 Stock are categorized as C (Standard stock item).

Phoenix

インデキサブルドリル

Indexable Drill

P3D

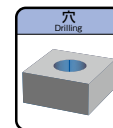

Specification

■形状寸法表 Specification

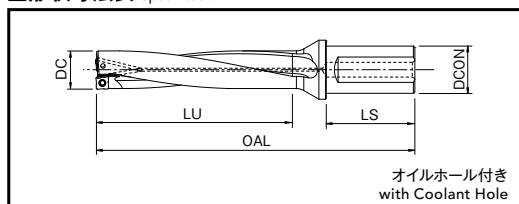

■加工径最大調整量 Max. Offset Amount of Effective Dia.

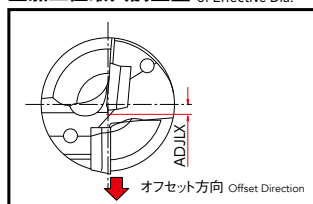

単位:mm Unit:mm

ツールNo. EDP No.	呼び Designation	外径 DC	全長 OAL	有効加工深さ LU	シャンク径 DCON	シャンク長 LS	最大 オフセット量 ADJLX	最大 加工径 DCX	適用インサート Applicable Inserts	標準価格 (Yen)
7803210	P3D1200FS20M03	12	99	36	20	50	0.4	12.8	①	47,100
7803211	P3D1250FS20M03	12.5	100.5	37.5	20	50	0.4	13.3		47,100
7803212	P3D1270FS20M03	12.7	101.1	38.1	20	50	0.3	13.3		47,100
7803213	P3D1300FS20M03	13	102	39	20	50	0.3	13.6		47,100
7803214	P3D1350FS20M03	13.5	103.5	40.5	20	50	0.2	13.9		47,100
7803215	P3D1400FS20M03	14	105	42	20	50	0.2	14.4		47,100
7803216	P3D1450FS20M03	14.5	106.5	43.5	20	50	0.1	14.7	47,100	
7803217	P3D1500FS20M04	15	110	45	20	50	0.4	15.8	②	47,100
7803218	P3D1550FS20M04	15.5	112	47	20	50	0.3	16.1		47,100
7803219	P3D1600FS20M04	16	113	48	20	50	0.3	16.6		47,100
7803220	P3D1650FS20M04	16.5	115	50	20	50	0.3	17.1	47,100	
7803221	P3D1700FS20M05	17	119	51	20	50	0.6	18.2	③	47,100
7803222	P3D1750FS20M05	17.5	121	53	20	50	0.5	18.5		47,100
7803290	P3D1750FS25M05		127		25	56				18.5
7803223	P3D1800FS25M05	18	128	54	25	56	0.5	19.0		47,100
7803224	P3D1850FS25M05	18.5	130	56	25	56	0.4	19.3		47,100
7803225	P3D1900FS25M06	19	131	57	25	56	0.6	20.2		47,100
7803226	P3D1950FS25M06	19.5	133	59	25	56	0.5	20.5	④	47,100
7803227	P3D2000FS25M06	20	134	60	25	56	0.4	20.8		47,100
7803228	P3D2050FS25M06	20.5	136	62	25	56	0.4	21.3		47,100
7803229	P3D2100FS25M07	21	142	63	25	56	0.6	22.2	⑤	47,100
7803230	P3D2150FS25M07	21.5	144	65	25	56	0.6	22.7		47,100
7803231	P3D2200FS25M07	22	145	66	25	56	0.5	23.0		47,100
7803232	P3D2250FS25M07	22.5	147	68	25	56	0.5	23.5		47,100
7803233	P3D2300FS25M07	23	148	69	25	56	0.4	23.8		47,100
7803291	P3D2350FS25M07	23.5	150	71	25	56	0.3	24.1		47,100
7803234	P3D2350FS32M07		154		32	60				47,100
7803292	P3D2400FS25M07	24	151	72	25	56	0.3	24.6		47,100
7803235	P3D2400FS32M07		155		32	60				47,100
7803293	P3D2450FS25M07	24.5	153	74	25	56	0.2	24.9		47,100
7803236	P3D2450FS32M07		157		32	60			47,100	
7803294	P3D2500FS25M08	25	154	75	25	56	0.7	26.4	52,200	
7803237	P3D2500FS32M08		158		32	60			52,200	
7803295	P3D2550FS25M08	25.5	156	77	25	56	0.6	26.7	52,200	
7803238	P3D2550FS32M08		160		32	60			52,200	
7803239	P3D2600FS32M08		26		161	78			32	60
7803240	P3D2650FS32M08	26.5	163	80	32	60	0.5	27.5	52,200	
7803241	P3D2700FS32M08	27	164	81	32	60	0.4	27.8	52,200	
7803300	P3D2750FS32M08	27.5	166	83	32	60	0.4	28.3	52,200	
7803242	P3D2800FS32M08	28	167	84	32	60	0.3	28.6	52,200	
7803243	P3D2850FS32M08	28.5	169	86	32	60	0.2	28.9	52,200	

FROM

単位:mm Unit:mm

ツールNo. EDP No.	呼び Designation	外径 DC	全長 OAL	有効加工深さ LU	シャンク径 DCON	シャンク長 LS	最大 オフセット量 ADJLX	最大 加工径 DCX	適用インサート Applicable Inserts	標準価格 (Yen)		
7803244	P3D2900FS32M09	29	170	87	32	60	0.8	30.6	⑦	60,400		
7803301	P3D2950FS32M09	29.5	172	89	32	60	0.8	31.1		60,400		
7803245	P3D3000FS32M09	30	173	90	32	60	0.7	31.4		60,400		
7803302	P3D3050FS32M09	30.5	175	92	32	60	0.7	31.9		60,400		
7803246	P3D3100FS32M09	31	176	93	32	60	0.6	32.2		60,400		
7803296	P3D3100FS40M09		186		40	70				60,400		
7803303	P3D3150FS32M09	31.5	178	95	32	60	0.5	32.5		60,400		
7803247	P3D3200FS32M09	32	179	96	32	60	0.5	33.0		60,400		
7803297	P3D3200FS40M09		189		40	70				60,400		
7803304	P3D3250FS40M09	32.5	191	98	40	70	0.4	33.3		60,400		
7803248	P3D3300FS40M09	33	192	99	40	70	0.4	33.8		60,400		
7803249	P3D3350FS40M09	33.5	194	101	40	70	0.2	33.9		60,400		
7803250	P3D3400FS40M10	34	195	102	40	70	1.1	36.2		⑧	63,900	
7803305	P3D3450FS40M10	34.5	197	104	40	70	0.9	36.3			63,900	
7803251	P3D3500FS40M10	35	198	105	40	70	0.8	36.6	63,900			
7803306	P3D3550FS40M10	35.5	200	107	40	70	0.7	36.9	63,900			
7803252	P3D3600FS40M10	36	201	108	40	70	0.8	37.6	63,900			
7803253	P3D3700FS40M10	37	204	111	40	70	0.6	38.2	63,900			
7803307	P3D3750FS40M10	37.5	206	113	40	70	0.4	38.3	63,900			
7803254	P3D3800FS40M10	38	207	114	40	70	0.3	38.6	63,900			
7803255	P3D3900FS40M12	39	217	117	40	70	1.0	41.0	⑨		72,500	
7803256	P3D4000FS40M12	40	220	120	40	70	0.9	41.8			72,500	
7803308	P3D4050FS40M12	40.5	222	122	40	70	0.8	42.1			72,500	
7803257	P3D4100FS40M12	41	223	123	40	70	0.8	42.6			72,500	
7803258	P3D4200FS40M12	42	226	126	40	70	0.6	43.2			72,500	
7803259	P3D4300FS40M12	43	229	129	40	70	0.5	44.0			72,500	
7803260	P3D4400FS40M12	44	232	132	40	70	0.3	44.6		72,500		
7803261	P3D4500FS40M13	45	235	135	40	70	0.9	46.8		⑩	86,900	
7803262	P3D4600FS40M13	46	238	138	40	70	0.8	47.6			86,900	
7803263	P3D4700FS40M13	47	241	141	40	70	0.7	48.4			86,900	
7803264	P3D4800FS40M13	48	244	144	40	70	0.5	49.0			86,900	
7803265	P3D4900FS40M13	49	247	147	40	70	0.3	49.6			86,900	
7803266	P3D5000FS40M14	50	250	150	40	70	1.1	52.2			⑪	96,300
7803309	P3D5050FS40M14	50.5	252	152	40	70	1.0	52.5				96,300
7803267	P3D5100FS40M14	51	253	153	40	70	1.0	53.0	96,300			
7803268	P3D5200FS40M14	52	256	156	40	70	0.8	53.6	96,300			
7803269	P3D5300FS40M14	53	259	159	40	70	0.7	54.4	96,300			
7803270	P3D5400FS40M14	54	262	162	40	70	0.6	55.2	96,300			
7803271	P3D5500FS40M14	55	265	165	40	70	0.4	55.8	96,300			
7803272	P3D5600FS40M14	56	268	168	40	70	0.1	56.2	96,300			
7803273	P3D5700FS40M16	57	271	171	40	70	1.1	59.2	⑫			125,000
7803274	P3D5800FS40M16	58	274	174	40	70	1.0	60.0		125,000		
7803275	P3D5900FS40M16	59	277	177	40	70	0.9	60.8		125,000		
7803276	P3D6000FS40M16	60	280	180	40	70	0.8	61.6		125,000		
7803277	P3D6100FS40M16	61	283	183	40	70	0.6	62.2		125,000		
7803278	P3D6200FS40M16	62	286	186	40	70	0.4	62.8		125,000		
7803279	P3D6300FS40M16	63	289	189	40	70	0.2	63.4		125,000		

青字 = 切削タップ下穴 Blue = pre-drilled hole for cutting taps
 ねじの呼びに対応した推奨下穴径はp.16をご参照下さい。
 Please see p.16 for recommended pre-drilled hole size.

在庫区分は全てC(標準在庫品)となります。 Stock are categorized as C (Standard stock item).

Phoenix

インデキサブルドリル

Indexable Drill

P4D

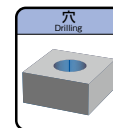

Specification

■形状寸法表 Specification

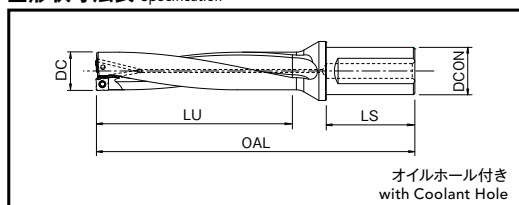

■加工径最大調整量 Max Offset Amount of Effective Dia.

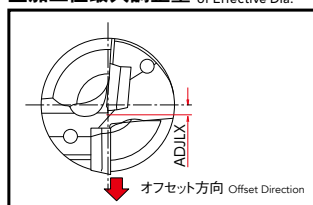

単位:mm Unit:mm

ツールNo. EDP No.	呼び Designation	外径 DC	全長 OAL	有効加工深さ LU	シャンク径 DCON	シャンク長 LS	最大 オフセット量 ADJLX	最大 加工径 DCX	適用インサート Applicable Inserts	標準価格 (Yen)
7803311	P4D1200FS20M03	12	111	48	20	50	0.4	12.8	①	56,100
7803312	P4D1250FS20M03	12.5	113	50	20	50	0.4	13.3		56,100
7803313	P4D1300FS20M03	13	115	52	20	50	0.3	13.6		56,100
7803314	P4D1350FS20M03	13.5	117	54	20	50	0.2	13.9		56,100
7803315	P4D1400FS20M03	14	119	56	20	50	0.2	14.4		56,100
7803316	P4D1450FS20M03	14.5	121	58	20	50	0.1	14.7	56,100	
7803317	P4D1500FS20M04	15	125	60	20	50	0.4	15.8	②	73,800
7803318	P4D1550FS20M04	15.5	127	62	20	50	0.3	16.1		73,800
7803319	P4D1600FS20M04	16	129	64	20	50	0.3	16.6		73,800
7803320	P4D1650FS20M04	16.5	131	66	20	50	0.3	17.1		73,800
7803321	P4D1700FS20M05	17	136	68	20	50	0.6	18.2		73,800
7803322	P4D1750FS20M05	17.5	138	70	20	50	0.5	18.5	③	73,800
7803390	P4D1750FS25M05		144		25	56				73,800
7803323	P4D1800FS25M05	18	146	72	25	56	0.5	19.0		73,800
7803324	P4D1850FS25M05	18.5	148	74	25	56	0.4	19.3		73,800
7803325	P4D1900FS25M06	19	150	76	25	56	0.6	20.2		73,800
7803326	P4D1950FS25M06	19.5	152	78	25	56	0.5	20.5	④	73,800
7803327	P4D2000FS25M06	20	154	80	25	56	0.4	20.8		73,800
7803328	P4D2050FS25M06	20.5	156	82	25	56	0.4	21.3		73,800
7803329	P4D2100FS25M07	21	163	84	25	56	0.6	22.2		73,800
7803330	P4D2150FS25M07	21.5	165	86	25	56	0.6	22.7		73,800
7803331	P4D2200FS25M07	22	167	88	25	56	0.5	23.0	73,800	
7803332	P4D2250FS25M07	22.5	169	90	25	56	0.5	23.5	73,800	
7803333	P4D2300FS25M07	23	171	92	25	56	0.4	23.8	73,800	
7803391	P4D2350FS25M07	23.5	173	94	25	56	0.3	24.1	⑤	73,800
7803334	P4D2350FS32M07		177		32	60				73,800
7803392	P4D2400FS25M07	24	175	96	25	56	0.3	24.6		73,800
7803335	P4D2400FS32M07		179		32	60				73,800
7803393	P4D2450FS25M07	24.5	177	98	25	56	0.2	24.9		73,800
7803336	P4D2450FS32M07		181		32	60			73,800	

FROM

単位:mm Unit:mm

ツールNo. EDP No.	呼び Designation	外径 DC	全長 OAL	有効加工深さ LU	シャンク径 DCON	シャンク長 LS	最大 オフセット量 ADJLX	最大 加工径 DCX	適用インサート Applicable Inserts	標準価格 (Yen)
7803394	P4D2500FS25M08	25	179	100	25	56	0.7	26.4	⑥	78,600
7803337	P4D2500FS32M08		183		32	60				78,600
7803395	P4D2550FS25M08	25.5	181	102	25	56	0.6	26.7		78,600
7803338	P4D2550FS32M08		185		32	60				78,600
7803339	P4D2600FS32M08	26	187	104	32	60	0.5	27.0		78,600
7803340	P4D2650FS32M08	26.5	189	106	32	60	0.5	27.5		78,600
7803341	P4D2700FS32M08	27	191	108	32	60	0.4	27.8		78,600
7803342	P4D2800FS32M08	28	195	112	32	60	0.3	28.6		78,600
7803343	P4D2850FS32M08	28.5	197	114	32	60	0.2	28.9		78,600
7803344	P4D2900FS32M09	29	199	116	32	60	0.8	30.6		83,200
7803345	P4D3000FS32M09	30	203	120	32	60	0.7	31.4		
7803346	P4D3100FS32M09	31	207	124	32	60	0.6	32.2	83,200	
7803396	P4D3100FS40M09		217		40	70			83,200	
7803347	P4D3200FS32M09	32	211	128	32	60	0.5	33.0	83,200	
7803397	P4D3200FS40M09		221		40	70			83,200	
7803348	P4D3300FS40M09	33	225	132	40	70	0.4	33.8	83,200	
7803349	P4D3350FS40M09	33.5	227	134	40	70	0.2	33.9	83,200	
7803350	P4D3400FS40M10	34	229	136	40	70	1.1	36.2	87,800	
7803351	P4D3500FS40M10	35	233	140	40	70	0.8	36.6		
7803352	P4D3600FS40M10	36	237	144	40	70	0.8	37.6		
7803353	P4D3700FS40M10	37	241	148	40	70	0.6	38.2		
7803354	P4D3800FS40M10	38	245	152	40	70	0.3	38.6		
7803355	P4D3900FS40M12	39	256	156	40	70	1.0	41.0		
7803356	P4D4000FS40M12	40	260	160	40	70	0.9	41.8	94,400	
7803357	P4D4100FS40M12	41	264	164	40	70	0.8	42.6		
7803358	P4D4200FS40M12	42	268	168	40	70	0.6	43.2		
7803359	P4D4300FS40M12	43	272	172	40	70	0.5	44.0		
7803360	P4D4400FS40M12	44	276	176	40	70	0.3	44.6		
7803361	P4D4500FS40M13	45	280	180	40	70	0.9	46.8	112,000	
7803362	P4D4600FS40M13	46	284	184	40	70	0.8	47.6		
7803363	P4D4700FS40M13	47	288	188	40	70	0.7	48.4		
7803364	P4D4800FS40M13	48	292	192	40	70	0.5	49.0		
7803365	P4D4900FS40M13	49	296	196	40	70	0.3	49.6	121,000	
7803366	P4D5000FS40M14	50	300	200	40	70	1.1	52.2		
7803367	P4D5100FS40M14	51	304	204	40	70	1.0	53.0		
7803368	P4D5200FS40M14	52	308	208	40	70	0.8	53.6	121,000	
7803369	P4D5300FS40M14	53	312	212	40	70	0.7	54.4		
7803370	P4D5400FS40M14	54	316	216	40	70	0.6	55.2		
7803371	P4D5500FS40M14	55	320	220	40	70	0.4	55.8		
7803372	P4D5600FS40M14	56	324	224	40	70	0.1	56.2	121,000	
7803373	P4D5700FS40M16	57	328	228	40	70	1.1	59.2		
7803374	P4D5800FS40M16	58	332	232	40	70	1.0	60.0		
7803375	P4D5900FS40M16	59	336	236	40	70	0.9	60.8	142,000	
7803376	P4D6000FS40M16	60	340	240	40	70	0.8	61.6		
7803377	P4D6100FS40M16	61	344	244	40	70	0.6	62.2		
7803378	P4D6200FS40M16	62	348	248	40	70	0.4	62.8		
7803379	P4D6300FS40M16	63	352	252	40	70	0.2	63.4		

在庫区分は全てC(標準在庫品)となります。 Stock are categorized as C (Standard stock item).

Phoenix

インデキサブルドリル

Indexable Drill

P5D

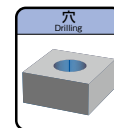

Specification

■形状寸法表 Specification

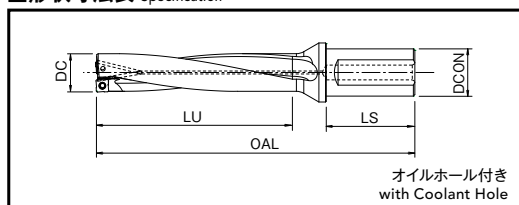

■加工径最大調整量 Max Offset Amount of Effective Dia.

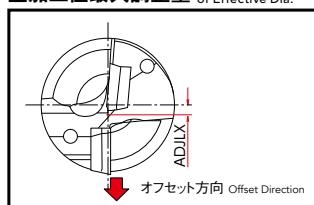

単位:mm Unit:mm

ツールNo. EDP No.	呼び Designation	外径 DC	全長 OAL	有効加工深さ LU	シャンク径 DCON	シャンク長 LS	最大 オフセット量 ADJLX	最大 加工径 DCX	適用インサート Applicable Inserts	標準価格 (Yen)
7802780	P5D1200FS20M03	12	123	60	20	50	0.4	12.8	①	62,100
7802781	P5D1250FS20M03	12.5	125.5	62.5	20	50	0.4	13.3		62,100
7802782	P5D1300FS20M03	13	128	65	20	50	0.3	13.6		62,100
7802783	P5D1350FS20M03	13.5	130.5	67.5	20	50	0.2	13.9		62,100
7802784	P5D1400FS20M03	14	133	70	20	50	0.2	14.4		62,100
7802785	P5D1450FS20M03	14.5	135.5	72.5	20	50	0.1	14.7	62,100	
7802717	P5D1500FS20M04	15	140	75	20	50	0.4	15.8	②	77,300
7802718	P5D1550FS20M04	15.5	143	78	20	50	0.3	16.1		77,300
7802719	P5D1600FS20M04	16	145	80	20	50	0.3	16.6		77,300
7802720	P5D1650FS20M04	16.5	148	83	20	50	0.3	17.1	77,300	
7802721	P5D1700FS20M05	17	153	85	20	50	0.6	18.2	③	77,300
7802722	P5D1750FS20M05	17.5	156	88	20	50	0.5	18.5		77,300
7802790	P5D1750FS25M05		162		25	56		77,300		
7802723	P5D1800FS25M05	18	164	90	25	56	0.5	19.0		77,300
7802724	P5D1850FS25M05	18.5	167	93	25	56	0.4	19.3		77,300
7802725	P5D1900FS25M06	19	169	95	25	56	0.6	20.2	④	77,300
7802726	P5D1950FS25M06	19.5	172	98	25	56	0.5	20.5		77,300
7802727	P5D2000FS25M06	20	174	100	25	56	0.4	20.8		77,300
7802728	P5D2050FS25M06	20.5	177	103	25	56	0.4	21.3		77,300
7802729	P5D2100FS25M07	21	184	105	25	56	0.6	22.2		77,300
7802730	P5D2150FS25M07	21.5	187	108	25	56	0.6	22.7	77,300	
7802731	P5D2200FS25M07	22	189	110	25	56	0.5	23.0	77,300	
7802732	P5D2250FS25M07	22.5	192	113	25	56	0.5	23.5	77,300	
7802733	P5D2300FS25M07	23	194	115	25	56	0.4	23.8	77,300	
7802791	P5D2350FS25M07	23.5	197	118	25	56	0.3	24.1	⑤	77,300
7802734	P5D2350FS32M07		201		32	60		77,300		
7802792	P5D2400FS25M07	24	199	120	25	56	0.3	24.6		77,300
7802735	P5D2400FS32M07		203		32	60		77,300		
7802793	P5D2450FS25M07	24.5	202	123	25	56	0.2	24.9		77,300
7802736	P5D2450FS32M07		206		32	60		77,300		

FROM

単位:mm Unit:mm

ツールNo. EDP No.	呼び Designation	外径 DC	全長 OAL	有効加工深さ LU	シャンク径 DCON	シャンク長 LS	最大 オフセット量 ADJLX	最大 加工径 DCX	適用インサート Applicable Inserts	標準価格 (Yen)
7802794	P5D2500FS25M08	25	204	125	25	56	0.7	26.4	⑥	82,400
7802737	P5D2500FS32M08		208		32	60				82,400
7802795	P5D2550FS25M08	25.5	207	128	25	56	0.6	26.7		82,400
7802738	P5D2550FS32M08		211		32	60				82,400
7802739	P5D2600FS32M08	26	213	130	32	60	0.5	27.0		82,400
7802740	P5D2650FS32M08	26.5	216	133	32	60	0.5	27.5		82,400
7802741	P5D2700FS32M08	27	218	135	32	60	0.4	27.8		82,400
7802742	P5D2800FS32M08	28	223	140	32	60	0.3	28.6		82,400
7802743	P5D2850FS32M08	28.5	226	143	32	60	0.2	28.9		82,400
7802744	P5D2900FS32M09	29	228	145	32	60	0.8	30.6		87,700
7802745	P5D3000FS32M09	30	233	150	32	60	0.7	31.4		87,700
7802746	P5D3100FS32M09	31	238	155	32	60	0.6	32.2		87,700
7802796	P5D3100FS40M09		248		40	70			87,700	
7802747	P5D3200FS32M09	32	243	160	32	60	0.5	33.0	87,700	
7802797	P5D3200FS40M09		253		40	70			87,700	
7802748	P5D3300FS40M09	33	258	165	40	70	0.4	33.8	87,700	
7802749	P5D3350FS40M09	33.5	261	168	40	70	0.2	33.9	87,700	
7802750	P5D3400FS40M10	34	263	170	40	70	1.1	36.2	92,100	
7802751	P5D3500FS40M10	35	268	175	40	70	0.8	36.6	92,100	
7802752	P5D3600FS40M10	36	273	180	40	70	0.8	37.6	92,100	
7802753	P5D3700FS40M10	37	278	185	40	70	0.6	38.2	92,100	
7802754	P5D3800FS40M10	38	283	190	40	70	0.3	38.6	92,100	
7802755	P5D3900FS40M12	39	295	195	40	70	1.0	41.0	98,900	
7802756	P5D4000FS40M12	40	300	200	40	70	0.9	41.8	98,900	
7802757	P5D4100FS40M12	41	305	205	40	70	0.8	42.6	98,900	
7802758	P5D4200FS40M12	42	310	210	40	70	0.6	43.2	98,900	
7802759	P5D4300FS40M12	43	315	215	40	70	0.5	44.0	98,900	
7802760	P5D4400FS40M12	44	320	220	40	70	0.3	44.6	98,900	
7802761	P5D4500FS40M13	45	325	225	40	70	0.9	46.8	117,000	
7802762	P5D4600FS40M13	46	330	230	40	70	0.8	47.6	117,000	
7802763	P5D4700FS40M13	47	335	235	40	70	0.7	48.4	117,000	
7802764	P5D4800FS40M13	48	340	240	40	70	0.5	49.0	117,000	
7802765	P5D4900FS40M13	49	345	245	40	70	0.3	49.6	117,000	
7802766	P5D5000FS40M14	50	350	250	40	70	1.1	52.2	130,000	
7802767	P5D5100FS40M14	51	355	255	40	70	1.0	53.0	130,000	
7802768	P5D5200FS40M14	52	360	260	40	70	0.8	53.6	130,000	
7802769	P5D5300FS40M14	53	365	265	40	70	0.7	54.4	130,000	
7802770	P5D5400FS40M14	54	370	270	40	70	0.6	55.2	130,000	
7802771	P5D5500FS40M14	55	375	275	40	70	0.4	55.8	130,000	
7802772	P5D5600FS40M14	56	380	280	40	70	0.1	56.2	130,000	
7802773	P5D5700FS40M16	57	385	285	40	70	1.1	59.2	154,000	
7802774	P5D5800FS40M16	58	390	290	40	70	1.0	60.0	154,000	
7802775	P5D5900FS40M16	59	395	295	40	70	0.9	60.8	154,000	
7802776	P5D6000FS40M16	60	400	300	40	70	0.8	61.6	154,000	
7802777	P5D6100FS40M16	61	405	305	40	70	0.6	62.2	154,000	
7802778	P5D6200FS40M16	62	410	310	40	70	0.4	62.8	154,000	
7802779	P5D6300FS40M16	63	415	315	40	70	0.2	63.4	154,000	

在庫区分は全てC(標準在庫品)となります。 Stock are categorized as C (Standard stock item).

Phoenix

インデキサブルドリル
Indexable Drill

インサート

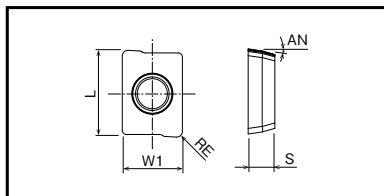
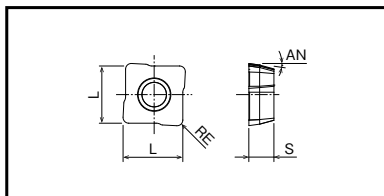

Inserts



Inserts

■適用インサート Inserts

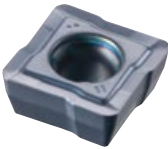
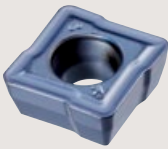
単位:mm Unit:mm

仕様 Specification	呼び Designation	切れ刃数 No. of Cutting Edges	適用ボディ Applicable Body	インサート寸法 Insert Size				超硬 Uncoated	コーティング材種 Grade of Coated Materials			標準価格 (Yen)
				L×W1	厚さ S	逃げ角 AN	RE		CK110	XP9020	XP1010	
 鋼 ステンレス鋼 for Steel & Stainless Steel	① XCMT031904ER-DM	2	φ12~14.5	6.1 × 4.5	1.9	8°	0.4		7823098		1,040	
	② XCMT042204ER-DM	4	φ15~16.5	5 × 5	2.2	8°	0.4		7823064		1,300	
	③ XCMT052404ER-DM	4	φ17~18.5	5.83 × 5.83	2.4	8°	0.4		7823065		1,350	
	④ XCMT062706ER-DM	4	φ19~20.5	6.46 × 6.46	2.7	8°	0.6		7823066		1,390	
	⑤ XCMT073106ER-DM	4	φ21~24.5	7.11 × 7.11	3.1	8°	0.6		7823067		1,410	
	⑥ XCMT083508ER-DM	4	φ25~28.5	8.36 × 8.36	3.5	8°	0.8		7823068		1,490	
	⑦ XCMT094008ER-DM	4	φ29~33.5	9.62 × 9.62	4	8°	0.8		7823069		1,620	
	⑧ XCMT104608ER-DM	4	φ34~38	10.89 × 10.89	4.6	8°	0.8		7823097		1,780	
	⑨ XCMT125010ER-DM	4	φ39~44	12.57 × 12.57	5	8°	1		7823071		2,330	
	⑩ XCMT135212ER-DM	4	φ45~49	14.05 × 14.05	5.2	8°	1.2		7823072		2,430	
	⑪ XCMT145612ER-DM	4	φ50~56	15.58 × 15.58	5.6	8°	1.2		7823073		2,560	
	⑫ XCMT165912ER-DM	4	φ57~63	17.28 × 17.28	5.9	8°	1.2		7823075		3,000	
 鑄鉄 for Cast Iron	① XCMT031904ER-DR	2	φ12~14.5	6.1 × 4.5	1.9	8°	0.4			7823163	1,040	
	② XCMT042204ER-DR	4	φ15~16.5	5 × 5	2.2	8°	0.4			7823164	1,300	
	③ XCMT052404ER-DR	4	φ17~18.5	5.83 × 5.83	2.4	8°	0.4			7823165	1,350	
	④ XCMT062706ER-DR	4	φ19~20.5	6.46 × 6.46	2.7	8°	0.6			7823166	1,390	
	⑤ XCMT073106ER-DR	4	φ21~24.5	7.11 × 7.11	3.1	8°	0.6			7823167	1,410	
	⑥ XCMT083508ER-DR	4	φ25~28.5	8.36 × 8.36	3.5	8°	0.8			7823168	1,490	
	⑦ XCMT094008ER-DR	4	φ29~33.5	9.62 × 9.62	4	8°	0.8			7823169	1,620	
	⑧ XCMT104608ER-DR	4	φ34~38	10.89 × 10.89	4.6	8°	0.8			7823197	1,780	
	⑨ XCMT125010ER-DR	4	φ39~44	12.57 × 12.57	5	8°	1			7823171	2,330	
	⑩ XCMT135212ER-DR	4	φ45~49	14.05 × 14.05	5.2	8°	1.2			7823172	2,430	
	⑪ XCMT145612ER-DR	4	φ50~56	15.58 × 15.58	5.6	8°	1.2			7823173	2,560	
	⑫ XCMT165912ER-DR	4	φ57~63	17.28 × 17.28	5.9	8°	1.2			7823175	3,000	
 アルミニウム 非鉄 for Aluminum(alloy) and Non-ferrous Metal	① XCMT031904ER-DN	2	φ12~14.5	6.1 × 4.5	1.9	8°	0.4	7823263			930	
	② XCMT042204ER-DN	4	φ15~16.5	5 × 5	2.2	8°	0.4	7823264			1,110	
	③ XCMT052404ER-DN	4	φ17~18.5	5.83 × 5.83	2.4	8°	0.4	7823265			1,170	
	④ XCMT062706ER-DN	4	φ19~20.5	6.46 × 6.46	2.7	8°	0.6	7823266			1,240	
	⑤ XCMT073106ER-DN	4	φ21~24.5	7.11 × 7.11	3.1	8°	0.6	7823267			1,330	
	⑥ XCMT083508ER-DN	4	φ25~28.5	8.36 × 8.36	3.5	8°	0.8	7823268			1,410	
	⑦ XCMT094008ER-DN	4	φ29~33.5	9.62 × 9.62	4	8°	0.8	7823269			1,540	
	⑧ XCMT104608ER-DN	4	φ34~38	10.89 × 10.89	4.6	8°	0.8	7823297			1,650	
	⑨ XCMT125010ER-DN	4	φ39~44	12.57 × 12.57	5	8°	1	7823271			2,090	
	⑩ XCMT135212ER-DN	4	φ45~49	14.05 × 14.05	5.2	8°	1.2	7823272			2,240	
	⑪ XCMT145612ER-DN	4	φ50~56	15.58 × 15.58	5.6	8°	1.2	7823273			2,380	
	⑫ XCMT165912ER-DN	4	φ57~63	17.28 × 17.28	5.9	8°	1.2	7823275			2,860	

ケースに専用ラベルが付いています
Indicating label



P2D/P3D/P4D/P5D 外周刃専用インサート Inserts for Peripheral Cutting Edge

単位:mm Unit:mm

仕様 Specification	呼び Designation	切れ刃数 No. of Cutting Edges	適用ボディ Applicable Body	インサート寸法 Insert Size				コーティング材種 Grade of Coated Materials	標準価格 (Yen)		
				L×W1	厚さ S	逃げ角 AN	RE				
								XC9015			
	鋼 鋳鉄 for Steel & Cast Iron	①	XCMT031904ER-DM	2	φ12~14.5	6.1 × 4.5	1.9	8°	0.4	7829098	1,040
		②	XCMT042204ER-DM	4	φ15~16.5	5 × 5	2.2	8°	0.4	7829064	1,300
		③	XCMT052404ER-DM	4	φ17~18.5	5.83 × 5.83	2.4	8°	0.4	7829065	1,350
		④	XCMT062706ER-DM	4	φ19~20.5	6.46 × 6.46	2.7	8°	0.6	7829066	1,390
		⑤	XCMT073106ER-DM	4	φ21~24.5	7.11 × 7.11	3.1	8°	0.6	7829067	1,410
		⑥	XCMT083508ER-DM	4	φ25~28.5	8.36 × 8.36	3.5	8°	0.8	7829068	1,490
		⑦	XCMT094008ER-DM	4	φ29~33.5	9.62 × 9.62	4	8°	0.8	7829069	1,620
		⑧	XCMT104608ER-DM	4	φ34~38	10.89 × 10.89	4.6	8°	0.8	7829097	1,780
		⑨	XCMT125010ER-DM	4	φ39~44	12.57 × 12.57	5	8°	1	7829071	2,330
		⑩	XCMT135212ER-DM	4	φ45~49	14.05 × 14.05	5.2	8°	1.2	7829072	2,430
		⑪	XCMT145612ER-DM	4	φ50~56	15.58 × 15.58	5.6	8°	1.2	7829073	2,560
		⑫	XCMT165912ER-DM	4	φ57~63	17.28 × 17.28	5.9	8°	1.2	7829075	3,000

Accessories

■ 部品 Accessories

	ツールNo. EDP No.	呼び Designation	適用インサート Applicable Inserts					
			①	②	③	④	⑤	⑥
	7808096	FS18536P (Torx 6IP)	①	XCMT0319...	-	-	-	-
	7808139	FS20543P (Torx 6IP)	②	XCMT0422...	③	XCMT0524...	-	-
	7808138	FS22550P (Torx 7IP)	④	XCMT0627...	-	-	-	-
	7808136	FS25560P (Torx 8IP)	⑤	XCMT0731...	-	-	-	-
	7808135	FS30570P (Torx 9IP)	⑥	XCMT0835...	⑦	XCMT0940...	-	-
	7808137	FS35586P (Torx 15IP)	⑧	XCMT1046...	⑨	XCMT1250...	-	-
	7808114	FS45510P (Torx 20IP)	⑩	XCMT1352...	⑪	XCMT1456...	⑫	XCMT1659...

	ツールNo. EDP No.	呼び Designation	適用インサート Applicable Inserts						標準価格 (Yen)
			①	②	③	④	⑤	⑥	
	7808223	6IP-D (Torx 6IP)	①	XCMT0319...	②	XCMT0422...	③	XCMT0524...	1,600
	7808224	7IP-D (Torx 7IP)	④	XCMT0627...	-	-	-	-	1,370
	7808225	8IP-D (Torx 8IP)	⑤	XCMT0731...	-	-	-	-	1,560
	7808226	9IP-D (Torx 9IP)	⑥	XCMT0835...	⑦	XCMT0940...	-	-	1,600
	7808228	15IP-D (Torx 15IP)	⑧	XCMT1046...	⑨	XCMT1250...	-	-	1,820
	7808229	20IP-D (Torx 20IP)	⑩	XCMT1352...	⑪	XCMT1456...	⑫	XCMT1659...	1,930

レンチは別途ご購入下さい。 The wrenches are sold separately from the cutters.

Cutting Conditions

■ 切削条件基準表 Cutting Conditions

被削材 Work Material	引張強さ・ 硬さ Tensile Strength・ Hardness	切削速度 Vc (m/min) Cutting Speed	送り量 f (mm/rev) Feed Rate							
			P2D・P3D							
			φ12-φ14.5	φ15-φ16.5	φ17-φ18.5	φ19-φ20.5	φ21-φ24.5	φ25-φ28.5	φ29-φ33.5	φ34-φ63
P 軟鋼、低炭素鋼 Mild Steel, Carbon Steel (S5400, S10C)	~180HB	200 (150~250)	0.06 (0.04~0.08)	0.06 (0.04~0.1)	0.06 (0.04~0.1)	0.07 (0.04~0.1)	0.08 (0.04~0.12)	0.08 (0.04~0.12)	0.1 (0.05~0.15)	0.1 (0.05~0.18)
	~280HB	150 (100~220)	0.08 (0.04~0.12)	0.08 (0.04~0.14)	0.09 (0.04~0.16)	0.1 (0.04~0.18)	0.14 (0.04~0.2)	0.18 (0.06~0.25)	0.2 (0.08~0.3)	0.2 (0.08~0.35)
		ダイス鋼 Die Steel (SKD11, SKD61)	120 (80~180)	0.06 (0.04~0.1)	0.06 (0.04~0.1)	0.07 (0.04~0.1)	0.08 (0.04~0.12)	0.12 (0.04~0.15)	0.14 (0.06~0.2)	0.18 (0.08~0.25)
M ステンレス鋼 Stainless Steel (SUS304, SUS420)	~250HB	130 (80~180)	0.07 (0.04~0.1)	0.07 (0.04~0.1)	0.08 (0.04~0.1)	0.09 (0.04~0.12)	0.1 (0.04~0.15)	0.13 (0.06~0.2)	0.15 (0.08~0.25)	0.15 (0.08~0.25)
K 鋳鉄 Cast Iron (FC250)	~350N/mm ²	200 (150~280)	0.08 (0.04~0.14)	0.08 (0.04~0.14)	0.1 (0.04~0.16)	0.12 (0.04~0.2)	0.16 (0.08~0.25)	0.2 (0.06~0.3)	0.2 (0.08~0.3)	0.2 (0.08~0.35)
	~800N/mm ²	160 (100~220)	0.08 (0.04~0.1)	0.08 (0.04~0.12)	0.09 (0.04~0.14)	0.1 (0.04~0.18)	0.14 (0.04~0.2)	0.18 (0.06~0.25)	0.18 (0.08~0.25)	0.18 (0.08~0.25)
N アルミニウム合金 Aluminum Alloy	~13%Si	200 (100~800)	0.08 (0.04~0.12)	0.08 (0.04~0.12)	0.1 (0.04~0.16)	0.12 (0.04~0.2)	0.16 (0.04~0.25)	0.2 (0.06~0.3)	0.2 (0.08~0.3)	0.2 (0.08~0.3)
S 超耐熱合金 Superalloy (Inconel 718)	—	50 (15~60)	0.04 (0.02~0.06)	0.04 (0.02~0.06)	0.05 (0.03~0.06)	0.05 (0.03~0.06)	0.06 (0.04~0.08)	0.08 (0.06~0.1)	0.1 (0.06~0.12)	0.1 (0.06~0.12)
	チタン合金 Titanium Alloy (Ti-6Al-4V)	60 (30~100)	0.05 (0.04~0.08)	0.05 (0.04~0.08)	0.06 (0.04~0.08)	0.06 (0.04~0.08)	0.08 (0.04~0.15)	0.1 (0.06~0.2)	0.14 (0.08~0.2)	0.14 (0.08~0.2)
H プリハードン鋼 Pre-hardened Steel (NAK80)	40~43HRC	100 (60~120)	0.06 (0.04~0.1)	0.06 (0.04~0.1)	0.06 (0.04~0.12)	0.07 (0.04~0.12)	0.08 (0.04~0.12)	0.1 (0.06~0.15)	0.1 (0.06~0.15)	0.1 (0.06~0.15)
	調質鋼 Hardened Steel (SKD11)	60 (40~80)	0.05 (0.04~0.08)	0.05 (0.04~0.08)	0.05 (0.04~0.08)	0.06 (0.04~0.08)	0.06 (0.04~0.08)	0.08 (0.04~0.1)	0.08 (0.04~0.1)	0.08 (0.04~0.1)

- この切削条件基準表は、水溶性切削油剤を内部給油にて使用する場合があります。
- 水溶性切削油剤は、希釈倍率20倍以下の良質のものをご使用下さい。
- 不水溶性切削油剤は推奨しません。
- この切削条件基準表は、実切削速度における一般的な値を示したものです。加工環境に合わせて適宜調整して下さい。
- インサート装着に際しては、傷や汚れを取り除いた状態でしっかりと取り付けて下さい。
- 被削材の保持はしっかりと行い、変形、たわみ、振動が起こらない状態にして下さい。
- オイルホールの詰まりは折損トラブルの原因になります。給油装置のフィルタは必ず装着して下さい。

被削材別推奨材質

Recommended Materials by Insert Type

◎第一推奨材質 Best
○第二推奨材質 Good

インサート材種 Insert Grades	ブレーカ Insert Breaker	切削油剤 Coolant	P	M	K	N	S	H
XP9020	DM	有 Wet	◎	◎	○	○	○	○
XP1010	DR	有 Wet	○		◎			
CK110	DN	有 Wet				◎		

外周刃専用インサート

Inserts for Peripheral Cutting Edge

◎第一推奨材質 Best
○第二推奨材質 Good

インサート材種 Insert Grades	ブレーカ Insert Breaker	切削油剤 Coolant	P	M	K	N	S	H
XC9015	DM	有 Wet	◎		◎			

		送り量 f (mm/rev) Feed Rate															
		P4D								P5D							
		φ12-φ14.5	φ15-φ16.5	φ17-φ18.5	φ19-φ20.5	φ21-φ24.5	φ25-φ28.5	φ29-φ33.5	φ34-φ63	φ12-φ14.5	φ15-φ16.5	φ17-φ18.5	φ19-φ20.5	φ21-φ24.5	φ25-φ28.5	φ29-φ33.5	φ34-φ63
		0.06 (0.04~0.08)	0.06 (0.04~0.08)	0.06 (0.04~0.08)	0.07 (0.04~0.1)	0.08 (0.04~0.12)	0.08 (0.04~0.12)	0.1 (0.05~0.15)	0.1 (0.05~0.18)	0.05 (0.04~0.08)	0.05 (0.04~0.08)	0.06 (0.04~0.08)	0.07 (0.04~0.1)	0.08 (0.04~0.12)	0.08 (0.04~0.12)	0.1 (0.05~0.15)	0.1 (0.05~0.18)
		0.07 (0.04~0.1)	0.08 (0.04~0.14)	0.08 (0.04~0.16)	0.09 (0.04~0.18)	0.12 (0.04~0.15)	0.18 (0.06~0.25)	0.2 (0.08~0.25)	0.2 (0.08~0.3)	0.06 (0.04~0.09)	0.06 (0.04~0.09)	0.08 (0.04~0.12)	0.08 (0.04~0.14)	0.12 (0.04~0.15)	0.15 (0.06~0.2)	0.18 (0.08~0.2)	0.18 (0.08~0.25)
		0.06 (0.04~0.08)	0.06 (0.04~0.1)	0.07 (0.04~0.1)	0.08 (0.04~0.12)	0.1 (0.04~0.13)	0.14 (0.06~0.2)	0.18 (0.08~0.25)	0.18 (0.08~0.25)	0.06 (0.04~0.08)	0.06 (0.04~0.08)	0.06 (0.04~0.08)	0.07 (0.04~0.1)	0.1 (0.04~0.13)	0.12 (0.06~0.15)	0.15 (0.08~0.18)	0.16 (0.08~0.22)
		0.06 (0.04~0.08)	0.06 (0.04~0.08)	0.07 (0.04~0.1)	0.08 (0.04~0.1)	0.08 (0.04~0.1)	0.13 (0.06~0.2)	0.15 (0.08~0.2)	0.15 (0.08~0.2)	0.06 (0.04~0.08)	0.06 (0.04~0.08)	0.06 (0.04~0.08)	0.07 (0.04~0.09)	0.08 (0.04~0.1)	0.1 (0.06~0.15)	0.12 (0.06~0.18)	0.12 (0.06~0.2)
		0.08 (0.04~0.12)	0.08 (0.04~0.14)	0.09 (0.04~0.16)	0.1 (0.04~0.2)	0.12 (0.04~0.15)	0.2 (0.06~0.3)	0.2 (0.08~0.3)	0.2 (0.08~0.3)	0.06 (0.04~0.1)	0.06 (0.04~0.1)	0.08 (0.04~0.12)	0.08 (0.04~0.13)	0.12 (0.04~0.15)	0.15 (0.06~0.2)	0.18 (0.08~0.2)	0.18 (0.08~0.25)
		0.08 (0.04~0.1)	0.08 (0.04~0.1)	0.08 (0.04~0.12)	0.09 (0.04~0.15)	0.12 (0.04~0.15)	0.15 (0.06~0.25)	0.18 (0.08~0.25)	0.18 (0.08~0.25)	0.06 (0.04~0.09)	0.06 (0.04~0.09)	0.08 (0.04~0.12)	0.08 (0.04~0.12)	0.1 (0.04~0.13)	0.12 (0.06~0.15)	0.15 (0.08~0.18)	0.18 (0.08~0.25)
		0.07 (0.04~0.12)	0.07 (0.04~0.12)	0.09 (0.04~0.12)	0.12 (0.04~0.2)	0.14 (0.04~0.2)	0.2 (0.06~0.3)	0.2 (0.08~0.3)	0.2 (0.08~0.3)	0.06 (0.04~0.1)	0.06 (0.04~0.1)	0.09 (0.04~0.12)	0.1 (0.04~0.15)	0.12 (0.04~0.15)	0.15 (0.06~0.25)	0.2 (0.08~0.3)	0.2 (0.08~0.3)
		0.04 (0.02~0.06)	0.04 (0.02~0.06)	0.04 (0.02~0.06)	0.04 (0.02~0.06)	0.05 (0.04~0.08)	0.07 (0.06~0.1)	0.08 (0.06~0.12)	0.08 (0.06~0.12)	0.04 (0.02~0.06)	0.04 (0.02~0.06)	0.04 (0.02~0.06)	0.04 (0.02~0.06)	0.04 (0.02~0.06)	0.07 (0.06~0.08)	0.07 (0.06~0.08)	0.07 (0.06~0.08)
		0.05 (0.04~0.08)	0.05 (0.04~0.08)	0.06 (0.04~0.08)	0.06 (0.04~0.08)	0.08 (0.04~0.1)	0.1 (0.06~0.2)	0.14 (0.08~0.2)	0.14 (0.08~0.2)	0.05 (0.04~0.08)	0.05 (0.04~0.08)	0.06 (0.04~0.08)	0.06 (0.04~0.08)	0.06 (0.04~0.1)	0.08 (0.06~0.15)	0.1 (0.08~0.15)	0.1 (0.08~0.15)
		0.06 (0.04~0.1)	0.06 (0.04~0.1)	0.06 (0.04~0.1)	0.06 (0.04~0.1)	0.08 (0.04~0.12)	0.08 (0.06~0.12)	0.1 (0.06~0.13)	0.1 (0.06~0.13)	0.06 (0.04~0.08)	0.06 (0.04~0.08)	0.06 (0.04~0.08)	0.06 (0.04~0.08)	0.08 (0.04~0.1)	0.08 (0.06~0.12)	0.1 (0.06~0.12)	0.1 (0.06~0.12)
		0.05 (0.04~0.08)	0.05 (0.04~0.08)	0.05 (0.04~0.08)	0.06 (0.04~0.08)	0.06 (0.04~0.08)	0.08 (0.04~0.1)	0.08 (0.04~0.1)	0.08 (0.04~0.1)	0.05 (0.04~0.07)	0.05 (0.04~0.07)	0.05 (0.04~0.07)	0.06 (0.04~0.07)	0.06 (0.04~0.08)	0.07 (0.04~0.1)	0.08 (0.04~0.1)	0.08 (0.04~0.1)

- The indicated speeds and feeds are for using water-soluble oil with inner supply.
- Suitable cutting fluid is water-soluble in high density (less than 20 times dilution).
- Using non-water-soluble oil is not recommended.
- The above cutting conditions are to be used as general guidelines. Adjustments may be necessary depending on actual cutting condition.
- Inserts should be attached to the holder tightly in a very neat condition.
- Fasten the work material to reduce the possibility of work deformation, deflection of machined surface, or vibration.
- A clogged oil hole can lead to a breakage. Make sure that a filter is attached to the oil feeder.

Pre-Drilled Hole Size for Tap

PD穴底段差量の目安値 Reference Value of PD Hmax

ドリル径 Drill Dia	Hmax (mm)
φ12~φ14.5	0.6
φ15~φ16.5	0.8
φ17~φ18.5	0.9
φ19~φ20.5	1.1
φ21~φ24.5	1.2
φ25~φ28.5	1.5
φ29~φ33.5	1.6
φ34~φ38	1.7
φ39~φ44	2
φ45~φ49	2.3
φ50~φ56	2.5
φ57~φ63	2.6

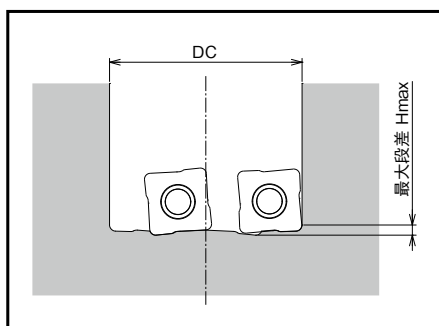

加工穴径の目安値 Reference Value of Hole Diameter

単位:mm Unit:mm

外径 DC	P2D・P3D	P4D・P5D
φ12~φ20.5	+0.25 0	+0.3 0
φ21~φ49	+0.3 0	+0.4 0
φ50~φ63	+0.35 0	+0.5 0

上記は推奨条件下での一般的な値を示したものです。加工環境によって異なる場合があります。
The above values are general recommendation and may differ based on actual machining condition.

タップ下穴径・推奨タップ一覧表 Recommended taps and size chart

P2D/P3D用 for P2D/P3D

切削タップ用 for Cutting Tap

ねじの呼び Thread Size	推奨下穴径 Recommended drill hole diameter	最小下穴径 Min. drill hole dia.		最大下穴径 Max. drill hole dia.		適応ボディ Applicable Body		推奨タップ ツールNo. Recommended Tap No.	
		各精度共通	旧JIS 2級用	6H用	P2D	P3D	A-SFT	A-POT	
M 14 × 2	12	11.84	12.21	12.21	P2D1200FS20M03	P3D1200FS20M03	8325347	-	
M 14 × 1.5	12.5	12.38	12.67	12.67	P2D1250FS20M03	P3D1250FS20M03	8325350	-	
M 16 × 2	14	13.9	14.2	14.21	P2D1400FS20M03	P3D1400FS20M03	8325357	8325157	
M 16 × 1.5	14.5	14.4	14.6	14.67	P2D1450FS20M03	P3D1450FS20M03	8325360	8325160	
M 17 × 1.5	15.5	15.4	15.68	15.67	P2D1550FS20M04	P3D1550FS20M04	8325364	8325164	
M 18 × 2.5	15.5	15.3	15.7	15.74			8325367	3825167	
M 18 × 2	16	15.9	16.2	16.21	P2D1600FS20M04	P3D1600FS20M04	8325369	8325169	
M 18 × 1.5	16.5	16.4	16.6	16.67	P2D1650FS20M04	P3D1650FS20M04	8325370	8325170	
M 20 × 2.5	17.5	17.3	17.7	17.74	P2D1750FS20M05	P3D1750FS20M05	8325377	8325177	
					P2D1750FS25M05	P3D1750FS25M05			
M 20 × 2	18	17.9	18.2	18.21	P2D1800FS25M05	P3D1800FS25M05	8325379	8325179	
M 20 × 1.5	18.5	18.4	18.6	18.67	P2D1850FS25M05	P3D1850FS25M05	8325380	8325180	
M 22 × 2.5	19.5	19.3	19.7	19.74	P2D1950FS25M06	P3D1950FS25M06	8325387	8325187	
M 22 × 2	20	19.9	20.2	20.21	P2D2000FS25M06	P3D2000FS25M06	8325389	8325189	
M 22 × 1.5	20.5	20.4	20.6	20.67	P2D2050FS20M06	P3D2050FS20M06	8325390	8325190	
M 24 × 3	21	20.8	21.2	21.25	P2D2100FS25M07	P3D2100FS25M07	8325397	8325197	
M 24 × 2	22	21.9	22.2	22.21	P2D2200FS25M07	P3D2200FS25M07	8325399	8325199	
M 24 × 1.5	22.5	22.4	22.6	22.67	P2D2250FS25M07	P3D2250FS25M07	8325400	8325200	
M 27 × 3	24	23.8	24.2	24.25	P2D2400FS25M07	P3D2400FS25M07	8326605		
					P2D2400FS32M07	P3D2400FS32M07			
					P2D2550FS25M08	P3D2550FS25M08			
M 27 × 1.5	25.5	25.4	25.6	25.67	P2D2550FS32M08	P3D2550FS32M08	8326608		
					P2D2650FS32M08	P3D2650FS32M08			
M 30 × 3.5	26.5	26.3	26.7	26.77	P2D2700FS32M08	P3D2700FS32M08	8326615		
M 30 × 3	27	26.8	27.2	27.25	P2D2850FS32M08	P3D2850FS32M08	8326618		
M 30 × 1.5	28.5	28.4	28.6	28.67	-	P3D2950FS32M09	8326624		
M 33 × 3.5	29.5	29.3	29.7	29.77	-	P3D3000FS32M09	8326625		
M 33 × 3	30	29.8	30.2	30.25	P2D3000FS32M09	P3D3000FS32M09	8326628		
M 33 × 1.5	31.5	31.4	31.6	31.67	-	P3D3150FS32M09	8326633		
M 36 × 4	32	31.7	32.2	32.27	P2D3200FS32M09	P3D3200FS32M09	8326633	-	
					P2D3200FS40M09	P3D3200FS40M09			
M 36 × 3	33	32.8	33.2	33.25	P2D3300FS40M09	P3D3300FS40M09	8326635		
M 36 × 1.5	34.5	34.4	34.6	34.67	-	P3D3450FS40M10	8326638		
M 39 × 4	35	34.7	35.2	35.27	P2D3500FS40M10	P3D3500FS40M10	8326643		
M 42 × 4.5	37.5	37.2	37.7	37.79	-	P3D3750FS40M10	8326652		
M 42 × 3	39	38.8	39.2	39.25	P2D3900FS40M12	P3D3900FS40M12	8326655		
M 42 × 1.5	40.5	40.4	40.6	40.67	-	P3D4050FS40M12	8326658		
M 45 × 4.5	40.5	40.2	40.7	40.79			8326659		
M 48 × 5	43	42.6	43.2	43.29	P2D4300FS40M12	P3D4300FS40M12	8326661		
M 48 × 3	45	44.8	45.2	45.25	P2D4500FS40M13	P3D4500FS40M13	8326665		
M 56 × 5.5	50.5	50.1	50.7	50.7	-	P3D5050FS40M14	8326670		

※エンドミルシャンク、ロングシャンクのツールNo.については「高能率・多機能タップ A-TAP」カタログをご参照下さい。
For additional sizes and styles, please refer to the high efficiency, multi-purpose A-Tap series catalog.

Performance Evaluation & Cutting Data

■性能評価と加工データ Performance Evaluation & Cutting Data

■過酷な5Dの深穴でも安定加工

Achieves stable drilling, even when making rigorous, 5xD deep holes

被削材：S50C
Work Material

使用機械：横形マシニングセンタ
Machine Horizontal Machining Center

工具径：φ25
Drill Diameter

切削油剤：水溶性切削油剤
Coolant Water-Soluble

穴深さ：125mm
Depth of Hole

切削条件：Vc=150m/min、f=0.12mm/rev
Cutting Conditions

■従来品 Conventional Indexable Drill

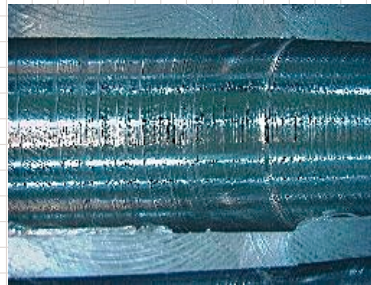
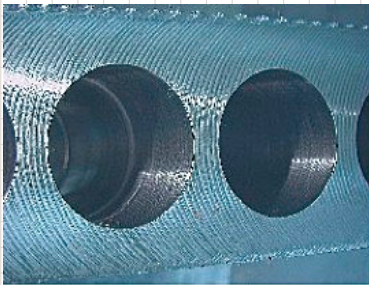

断面写真 Cross-sectional

- 従来のインデキサブルドリルでは、5Dの深穴加工は非常に困難。
- インデキサブルドリルは2溝1刃のため、径方向の負荷バランスが悪く、横荷重がかかりやすい。深穴ではその影響は一層大きくなる。
- 5xD deep hole drilling was an extremely difficult process for conventional indexable drills.
- Since conventional indexable drills are constructed of two flutes and a cutting edge, its load balance is relatively poor especially when drilling deep holes.



■P5D

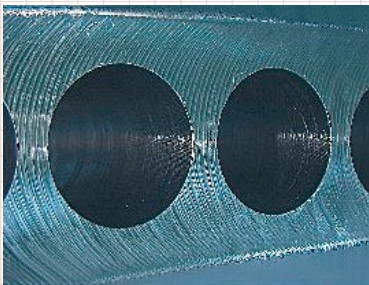

- 段差の少ない安定加工が可能！
- 5Dの深穴加工を基準とした専用設計で安定加工が可能！
- Achieves stable drilling with minimal irregularity!
- The P5D is designed specifically for stable drilling of 5xD deep holes.

■安定した切削負荷

Stable cutting load

被削材：S50C
Work Material

使用機械：横形マシニングセンタ(BT50)
Machine Horizontal Machining Center

工具径：φ21
Drill Diameter

切削油剤：水溶性切削油剤
Coolant Water-Soluble

穴深さ：50mm
Depth of Hole

切削条件：Vc=120m/min、f=0.12mm/rev
Cutting Conditions

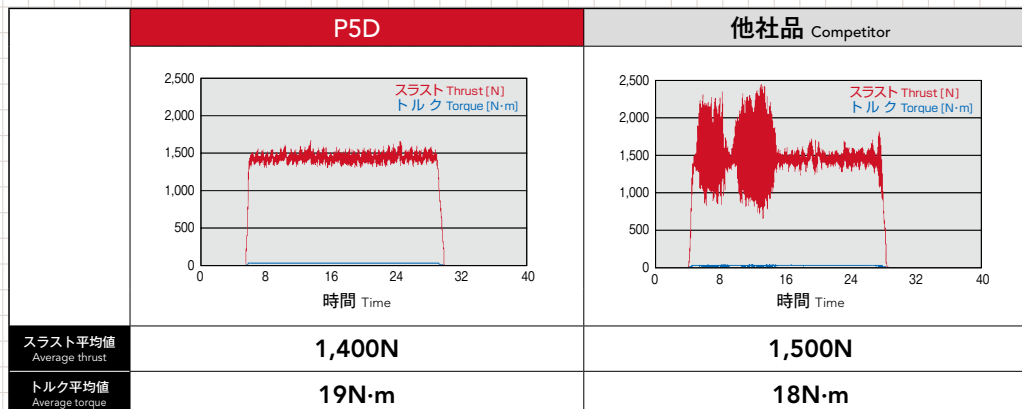

Performance Evaluation & Cutting Data



■性能評価と加工データ Performance Evaluation & Cutting Data

金型部品の高性能穴あけ加工(P3D) High efficiency drilling in mold parts (P3D)

使用工具 Tool	P3D2500FS32M08 (φ25)	他社インデキサブルドリル (φ25) Competitor's Indexable Drill
使用インサート(材種) Insert (grade)	XCMT083508ER-DM (XP9020)	超硬コーティングインサート Coated Carbide Insert
被削材 Work Material	S50C	
切削速度 Cutting Speed	200m/min (2,550min ⁻¹)	167m/min (2,100min ⁻¹)
送り速度 Feed	300mm/min (0.12mm/rev)	170mm/min (0.08mm/rev)
穴深さ Depth of Hole	50mm(通り) (Through)	
切削油剤 Coolant	水溶性切削油剤(内部給油) Water-Soluble (Internal)	
使用機械 Machine	立形マシニングセンタ (BT40) Vertical Machining Center	

他社品では加工条件を上げると切りくずがつまり加工が困難であったが、P3Dは加工条件を上げて切りくずを細かく分断できるため排出性が良好で、大幅な加工時間短縮を行うことができた。

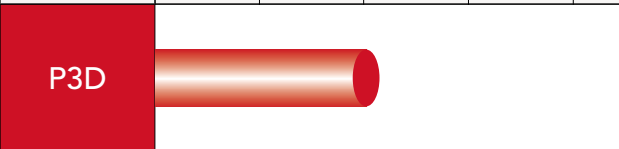
The competitor product exhibited difficulties in the separation of cutting chips, whereas the P3D was able to break chips into small pieces for trouble-free evacuation, reducing processing time significantly.

	加工時間(秒/穴) Cutting Time (sec./hole)			
	5	10	15	20
P3D				
他社品 Competitor				

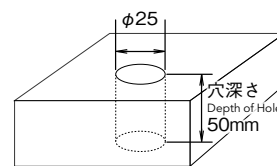



P3Dの切りくず Cutting Chips of P3D

構造物の高性能穴あけ加工(P4D) High efficiency drilling of structural part (P4D)

使用工具 Tool	P4D3300FS40M09 (φ33)	他社インデキサブルドリル (φ33) Competitor's Indexable Drill
使用インサート(材種) Insert (grade)	XCMT094008ER-DM (XP9020)	超硬コーティングインサート Coated Carbide Insert
被削材 Work Material	SS400	
切削速度 Cutting Speed	220m/min (2,100min ⁻¹)	165m/min (1,600min ⁻¹)
送り速度 Feed	150mm/min (0.07mm/rev)	110mm/min (0.07mm/rev)
穴深さ Depth of Hole	100mm(止り) (Blind)	
切削油剤 Coolant	水溶性切削油剤(内部給油) Water-Soluble (Internal)	
使用機械 Machine	横形マシニングセンタ (BT50) Horizontal Machining Center	

従来、加工深さ70mm以降は切りくずつまりのため2mmのステップ加工を行っていた。深穴でも切りくず排出性に優れたP4Dを使用することでノンステップで加工ができ、さらに加工条件もUPさせることができたので、1穴当りの加工時間を45%短縮することができた。

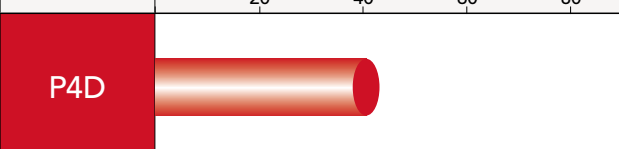
To prevent chip clogging, 2mm step-drilling was commonly required for applications with a depth of over 70mm. The P4D, however, was able to demonstrate excellent chip evacuation even in deep-hole with no step processing required, improving performance with the reduction of machining time by 45% per hole.

	加工時間(秒/穴) Cutting Time (sec./hole)			
	20	40	60	80
P4D				
他社品 Competitor				

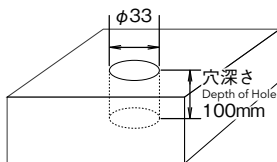

SUS304でも安定加工(P5D) Stable performance even in SUS304 (P5D)

使用工具 Tool	P5D1500FS20M04 (φ15)	他社品 A Competitor	他社品 B Competitor
使用インサート(材種) Insert (grade)	XCMT042204ER-DM (XP9020)	超硬コーティングインサート Coated Carbide Insert	
被削材 Work Material	SUS304		
切削速度 Cutting Speed	120m/min (2,550min ⁻¹)		
送り速度 Feed	150mm/min (0.06mm/rev)		
穴深さ Depth of Hole	75mm(止り) (Blind)		
切削油剤 Coolant	水溶性切削油剤(内部給油) Water-Soluble (Internal)		
使用機械 Machine	横形マシニングセンタ(BT40) Horizontal Machining Center		

SUS304の加工において長寿命が実現できた。
 The P5D was able to achieve long tool life by drilling SUS304.

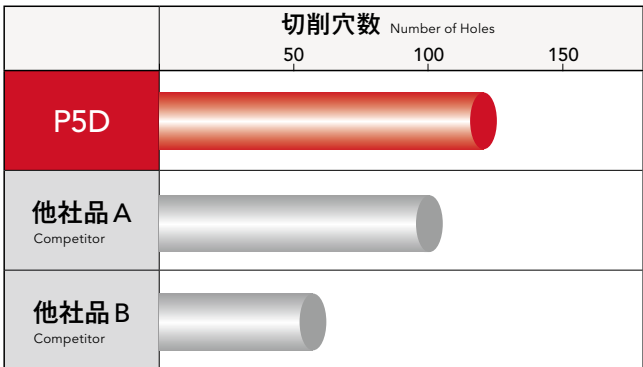
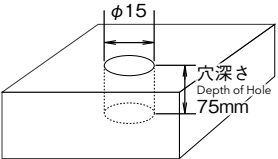

FC250の長寿命加工(P5D) Drilling with long tool life in FC250 (P5D)

使用工具 Tool	P5D2500FS32M08 (φ25)	他社インデキサブルドリル(φ25) Competitor's Indexable Drill
使用インサート(材種) Insert (grade)	XCMT083508ER-DR (XP1010)	超硬コーティングインサート Coated Carbide Insert
被削材 Work Material	FC250	
切削速度 Cutting Speed	150m/min (1,910min ⁻¹)	
送り速度 Feed	200mm/min (0.1mm/rev)	
穴深さ Depth of Hole	100mm(止り) (Blind)	
切削油剤 Coolant	水溶性切削油剤(内部給油) Water-Soluble (Internal)	
使用機械 Machine	横形マシニングセンタ(BT50) Horizontal Machining Center	

他社品の耐久の1.3倍となる、250穴の加工を行ったが安定した加工が可能であった。
 P5D achieved stable drilling of 250 holes, which was over 1.3 times, versus the competition.

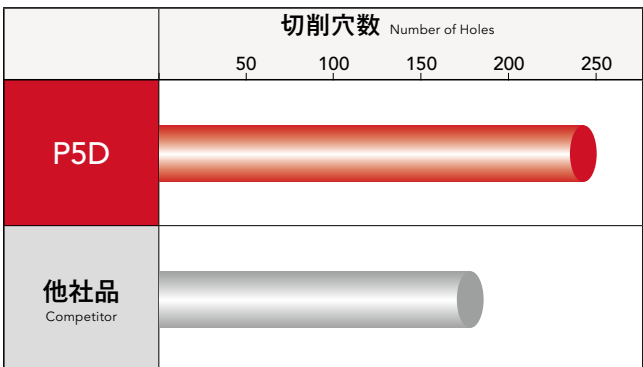
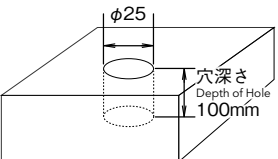

Cutting Data

■加工データ Cutting Data

ADC12の長寿命加工(P5D) Drilling with long tool life in ADC12 (P5D)

使用工具 Tool	P5D2500FS32M08 (φ25)	他社インデキサブルドリル (φ25) Competitor's Indexable Drill
使用インサート(材種) Insert (grade)	XCMT083508ER-DN (CK110)	超硬インサート Carbide Insert
被削材 Work Material	ADC12	
切削速度 Cutting Speed	250m/min (3,185min ⁻¹)	
送り速度 Feed	320mm/min (0.1mm/rev)	
穴深さ Depth of Hole	100mm(止り) (Blind)	
切削油剤 Coolant	水溶性切削油剤(内部給油) Water-Soluble (Internal)	
使用機械 Machine	横形マシニングセンタ(BT50) Horizontal Machining Center	

200穴加工時の摩耗比較 Wear comparison after 200 holes of drilling

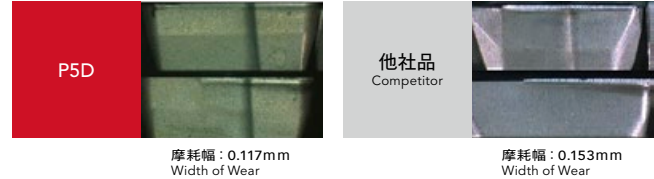

アルミニウム合金・非鉄用インサートを用いたADC12の加工において長寿命が実現できた。

Long tool life was achieved in machining ADC12 by using inserts for aluminum alloy and non-ferrous materials.

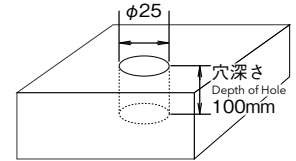

高硬度材の長寿命加工(P3D) Drilling with long tool life in high-hardened material (P3D)

使用工具 Tool	P3D2100FS25M07 (φ21)	他社インデキサブルドリル (φ21) Competitor's Indexable Drill
使用インサート(材種) Insert (grade)	XCMT073106ER-DM (XP9020)	超硬コーティングインサート Coated Carbide Insert
被削材 Work Material	SKD61 (50HRC)	
切削速度 Cutting Speed	80m/min (1,200min ⁻¹)	
送り速度 Feed	100mm/min (0.08mm/rev)	
穴深さ Depth of Hole	63mm(止り) (Blind)	
切削油剤 Coolant	水溶性切削油剤(内部給油) Water-Soluble (Internal)	
使用機械 Machine	横形マシニングセンタ(BT40) Horizontal Machining Center	

HRC50の高硬度材の加工において、他社品は30穴で中心刃が欠けてしまったが、P3Dは50穴加工後の損傷も軽微で継続加工が可能であった。

The competitor product exhibited chipping of the center blade after processing 30 holes in a high hardness material of HRC50. The P3D, on the other hand, was able to continue processing even after 50 holes with minimal wear.

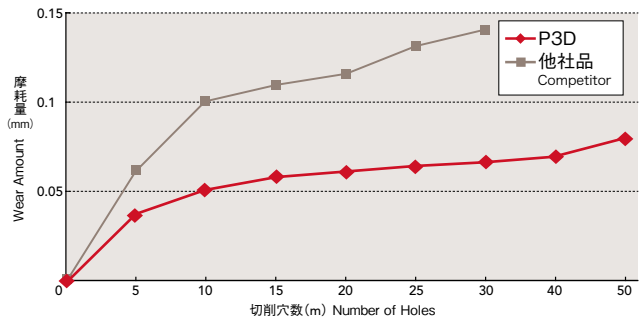
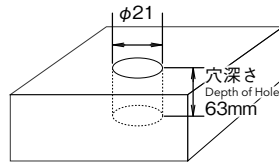

摩耗比較 Wear comparison



建機部品の旋削穴あけ加工(P4D) Turning of building component (P4D)

使用工具 Tool	P4D2200FS25M07 (φ22)	他社インデキサブルドリル (φ22) Competitor's Indexable Drill
使用インサート(材種) Insert (grade)	XCMT073106ER-DM (XP9020)	超硬コーティングインサート Coated Carbide Insert
被削材 Work Material	SCM415	
切削速度 Cutting Speed	104m/min (1,500min ⁻¹)	
送り速度 Feed	300mm/min (0.2mm/rev)	
穴深さ Depth of Hole	70mm(通り) (Through)	
切削油剤 Coolant	水溶性切削油剤(内部給油) Water-Soluble (Internal)	
使用機械 Machine	横形NC旋盤 Horizontal NC Lathe	

150穴加工後の損傷状態 Wear comparison after 150 holes of drilling

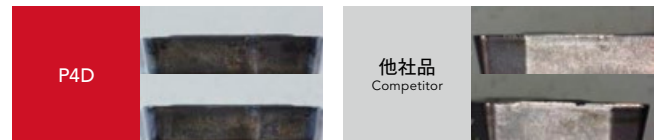

穴深さ70mmの旋削穴あけ加工において他社品はインサートがチッピングしたのに対し、深穴でも安定加工ができるP4Dは欠けもなく摩耗も軽微で継続使用可能な状態であった。

The insert of the competitor tool exhibited chipping during the processing of a 70mm deep-hole turning application while the P4D was able to continue processing with minimal wear shown.

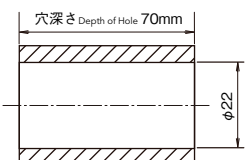

特殊品にも対応

Customization Available

面取り付き等、加工に合わせた
特殊品も承っております。
詳細は当社営業までお問い合わせ
下さい。

Custom tooling with specifications such as chamfering are
available upon request.
Please contact your local sales representative for details.



面取り刃付きPDドリル(特殊品)

PD with Chamfering (Special)



座ぐり刃付きPDドリル(特殊品)

PD with Counterbore (Special)



大径(DC>φ63)加工用PDドリル(特殊品)

PD for large diameter (DC > φ63, Special)

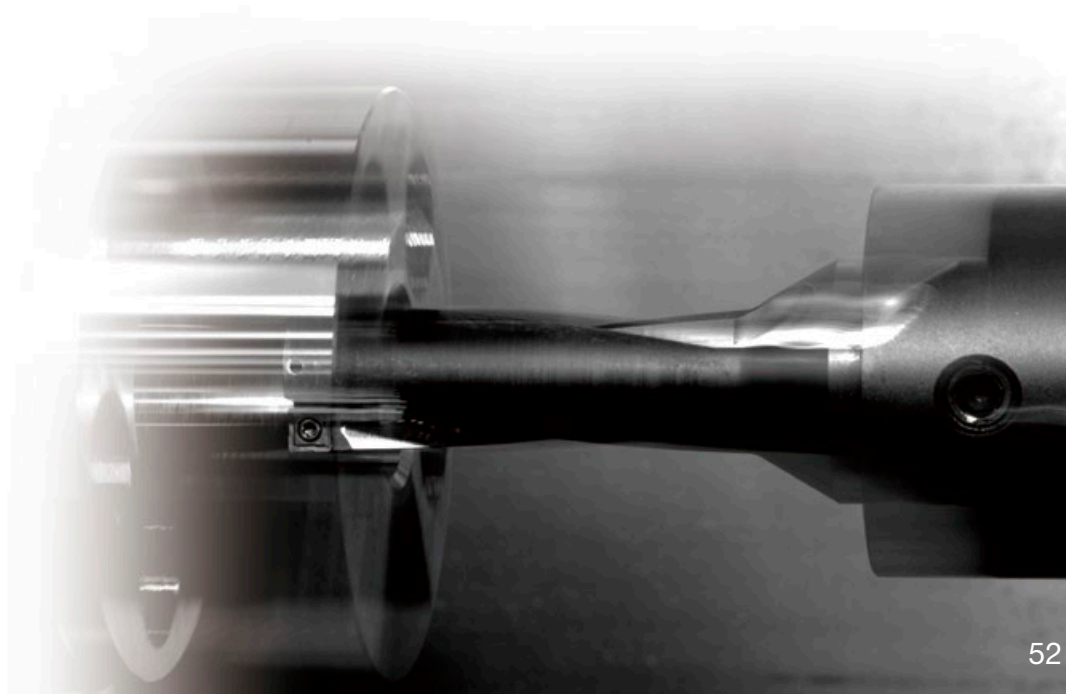

» Phoenix PHP

インデキサブルドリル 3D用
Indexable Drill for 3D

Phoenix High Performance drill



■独自の形状で様々な加工形態に対応

Unique design supports many types of machining

■インサートの配列 Insert arrangement

- ・先端角形状により食い付き時の抵抗を低減
Point angle shape reduces bite resistance
- ・配列バランスにより、高能率加工を実現
Balanced arrangement to achieve high efficiency machining
- ・中心、外周刃に同じインサートを使用できるため、工具管理が容易
The center and the peripheral edge of the same insert can be used, simplifying insert management.

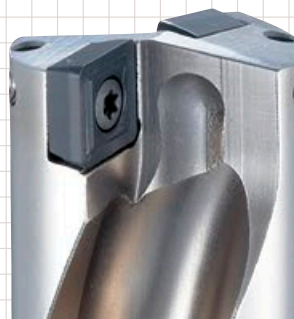

■溝フォームの最適化 Ideal flute form

切りくずの流れをコントロール Controls the flow of chips

■先端角形状により難しい加工形状に対応

Shaped corner tips for difficult drilling shapes

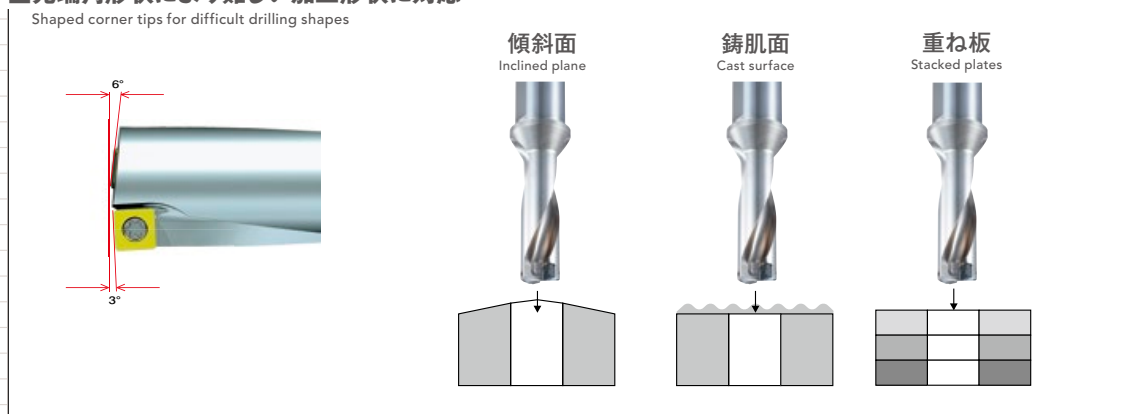

■高剛性ボディ High rigidity of body

高剛性による耐久性改善 High rigidity improves tool durability

■安定したトルク The stable torque

使用工具 Tool	PHP210FS25M07-3D (φ21)
使用インサート(材種) Insert(grade)	SCMT073206-DM(XP9040)
被削材 Work Material	S50C
切削速度 Cutting Speed	150m/min (2,275min ⁻¹)
送り速度 Feed	341mm/min (0.15mm/rev)
穴深さ Depth of Hole	50mm
切削油剤 Coolant	水溶性切削油剤(内部給油) Water-Soluble (Internal)
使用機械 Machine	立形マシニングセンタ(BT50) (26kW/30kW) Vertical Machining Center

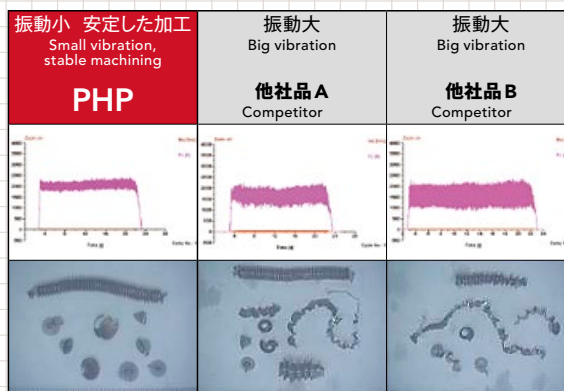

安定したトルクにより機械に与える負荷を低減

Stable torque minimizes the load imparted on the machine.

Phoenix

インデキサブルドリル 3D用

Indexable Drill for 3D

PHP

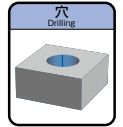

Specification

■形状寸法表 Specification

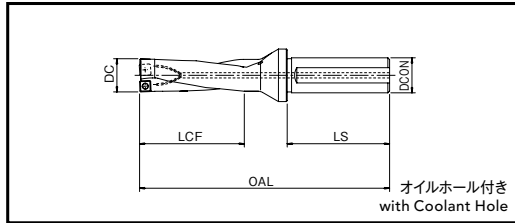

単位:mm Unit:mm

ツールNo. EDP No.	呼び Designation	外径 DC	全長 OAL	溝長 LCF	シャンク径 DCON	シャンク長 LS	適用インサート Applicable Inserts	標準価格 (Yen)
7800100	PHP140FS20M04-3D	14	116	42	20	50	①	78,400
7800101	PHP145FS20M04-3D	14.5	119	45	20	50		78,400
7800102	PHP150FS20M04-3D	15	119	45	20	50		78,400
7800103	PHP155FS20M04-3D	15.5	122	48	20	50		78,400
7800104	PHP160FS20M04-3D	16	122	48	20	50	②	78,400
7800105	PHP165FS20M05-3D	16.5	125	51	20	50		78,400
7800106	PHP170FS20M05-3D	17	125	51	20	50		78,400
7800107	PHP175FS25M05-3D	17.5	134	54	25	56		78,400
7800108	PHP180FS25M05-3D	18	134	54	25	56	③	79,200
7800109	PHP185FS25M06-3D	18.5	137	57	25	56		79,200
7800110	PHP190FS25M06-3D	19	137	57	25	56		79,200
7800111	PHP195FS25M06-3D	19.5	140	60	25	56		79,200
7800112	PHP200FS25M06-3D	20	140	60	25	56	④	79,200
7800113	PHP205FS25M06-3D	20.5	143	63	25	56		79,200
7800114	PHP210FS25M07-3D	21	143	63	25	56		79,200
7800115	PHP215FS25M07-3D	21.5	146	66	25	56		79,200
7800116	PHP220FS25M07-3D	22	146	66	25	56	⑤	82,700
7800117	PHP225FS25M07-3D	22.5	149	69	25	56		82,700
7800118	PHP230FS25M07-3D	23	149	69	25	56		82,700
7800119	PHP235FS32M07-3D	23.5	156	72	32	60		82,700
7800120	PHP240FS32M07-3D	24	156	72	32	60	⑥	82,700
7800121	PHP245FS32M08-3D	24.5	159	75	32	60		82,700
7800122	PHP250FS32M08-3D	25	159	75	32	60		82,700
7800123	PHP255FS32M08-3D	25.5	162	78	32	60		82,700
7800124	PHP260FS32M08-3D	26	162	78	32	60	⑦	82,700
7800125	PHP265FS32M08-3D	26.5	165	81	32	60		82,700
7800126	PHP270FS32M08-3D	27	165	81	32	60		82,700
7800127	PHP280FS32M08-3D	28	168	84	32	60		92,600
7800128	PHP290FS32M10-3D	29	171	87	32	60	⑧	92,600
7800130	PHP300FS32M10-3D	30	179	90	32	60		92,600
7800131	PHP310FS32M10-3D	31	182	93	32	60		92,600
7800132	PHP320FS32M10-3D	32	185	96	32	60		92,600
7800133	PHP330FS40M10-3D	33	196	99	40	68	⑨	92,600
7800134	PHP340FS40M10-3D	34	199	102	40	68		119,000
7800135	PHP350FS40M12-3D	35	202	105	40	68		119,000
7800136	PHP360FS40M12-3D	36	205	108	40	68		119,000
7800137	PHP370FS40M12-3D	37	218	111	40	68		119,000
7800138	PHP380FS40M12-3D	38	221	114	40	68		119,000
7800139	PHP390FS40M12-3D	39	224	117	40	68		119,000
7800140	PHP400FS40M12-3D	40	227	120	40	68		119,000

青字 = 切削タップ下穴 Blue = tap drill hole for cutting taps

ねじの呼びに対応した推奨下穴径はp.16をご参照下さい。
Please see p.16 for recommended tap pilot hole size.

在庫区分は全てC(標準在庫品)となります。 Stock are categorized as C (Standard stock item).

Phoenix

インデキサブルドリル 3D用

Indexable Drill for 3D

PHPインサート

Inserts

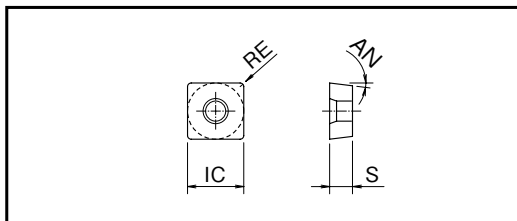

Inserts

■適用インサート Inserts

単位:mm Unit:mm

呼び Designation	切れ刃数 Number of Cutting Edges	適用ボディ Applicable Body	インサート寸法 Insert Size				コーティング材種 Grade of Coated Materials		標準価格 (Yen)
			IC	厚さ S	逃げ角 AN	RE	XP9040	XC9025	
① SCMT042204-DM	4	φ14~16	4.8	2.2	7°	0.4	7818001	7817001	1,610
② SCMT052404-DM	4	φ16.5~18	5.4	2.4	7°	0.4	7818002	7817002	1,610
③ SCMT062806-DM	4	φ18.5~20.5	6.2	2.8	7°	0.6	7818003	7817003	1,660
④ SCMT073206-DM	4	φ21~24	7.2	3.2	7°	0.6	7818004	7817004	1,720
⑤ SCMT083608-DM	4	φ24.5~28	8.6	3.6	7°	0.8	7818005	7817005	1,760
⑥ SCMT104208-DM	4	φ29~34	10	4.2	7°	0.8	7818006	7817006	1,810
⑦ SCMT125008-DM	4	φ35~40	12.3	5	7°	0.8	7818007	7817007	1,870

Accessories

■部品 Accessories

	ツールNo. EDP No.	呼び Designation	適用インサート Applicable Inserts	
 クランプねじ Clamping Screw	7808100	FS18538 (Torx 6)	①	SCMT042204-DM
	7808102	FS20540 (Torx 6)	②	SCMT052404-DM
	7808104	FS22550 (Torx 7)	③	SCMT062806-DM
	7808108	FS25560 (Torx 8)	④	SCMT073206-DM
	7808110	FS30573 (Torx 8)	⑤	SCMT083608-DM
	7808111	FS35572 (Torx 15)	⑥	SCMT104208-DM
	7808113	FS45510 (Torx 20)	⑦	SCMT125008-DM

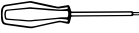
	ツールNo. EDP No.	呼び Designation	適用インサート Applicable Inserts		標準価格 (Yen)		
 レンチ Wrench	7808203	T6-D (Torx 6)	①	SCMT042204-DM	②	SCMT052404-DM	1,050
	7808204	T7-D (Torx 7)	③	SCMT062806-DM	—	—	1,050
	7808205	T8-D (Torx 8)	④	SCMT073206-DM	⑤	SCMT083608-DM	1,190
	7808208	T15-D (Torx 15)	⑥	SCMT104208-DM	—	—	1,260
	7808209	T20-D (Torx 20)	⑦	SCMT125008-DM	—	—	1,260

レンチは別途ご購入下さい。 The wrenches are sold separately from the cutters.

■被削材別推奨材質

Recommended Materials by Insert Type

◎第一推奨材質 Best
○第二推奨材質 Good

インサート材種 Insert Grades	ブレーカ Insert Breaker	切削油剤 Coolant	P	M	K	N	S	H
XP9040	DM	有 Wet	◎	◎		◎	○	
XC9025	DM	有 Wet	○	○	◎	○		

Cutting Conditions

■切削条件基準表 Cutting Conditions

被削材 Work Material	引張強さ・硬さ Tensile Strength・Hardness	切削速度 Vc (m/min) Cutting Speed	送り量 f (mm/rev) Feed Rate			
			φ14~φ20.5	φ21~φ28	φ29~φ34	φ35~φ40
P 軟鋼、低炭素鋼 Mild Steel, Carbon Steel (SS400, S10C) 炭素鋼、合金鋼 Carbon Steel, Alloy Steel (S50C, SCM440) ダイス鋼 Die Steel (SKD11, SKD61)	~180HB	200 (60 ~ 250)	0.09 (0.06 ~ 0.13)	0.13 (0.1 ~ 0.18)	0.18 (0.13 ~ 0.21)	0.25 (0.2 ~ 0.27)
	~280HB	160 (40 ~ 220)	0.09 (0.06 ~ 0.13)	0.13 (0.1 ~ 0.18)	0.18 (0.13 ~ 0.21)	0.25 (0.2 ~ 0.27)
	~280HB	140 (40 ~ 180)	0.08 (0.05 ~ 0.12)	0.12 (0.06 ~ 0.15)	0.14 (0.09 ~ 0.18)	0.15 (0.1 ~ 0.2)
M ステンレス鋼 Stainless Steel (SUS304, SUS420)	~250HB	150 (60 ~ 180)	0.08 (0.05 ~ 0.12)	0.1 (0.06 ~ 0.12)	0.15 (0.1 ~ 0.17)	0.18 (0.15 ~ 0.2)
K 鋳鉄 Cast Iron (FC250) ダクタイル鋳鉄 Ductile Cast Iron (FCD400)	~350N/mm ²	150 (60 ~ 180)	0.09 (0.06 ~ 0.13)	0.13 (0.1 ~ 0.18)	0.18 (0.13 ~ 0.21)	0.25 (0.2 ~ 0.27)
	~800N/mm ²	130 (40 ~ 150)	0.09 (0.06 ~ 0.13)	0.12 (0.08 ~ 0.16)	0.16 (0.1 ~ 0.2)	0.2 (0.15 ~ 0.25)
N アルミニウム合金 Aluminum Alloy	~13%Si	220 (100 ~ 800)	0.09 (0.06 ~ 0.2)	0.13 (0.1 ~ 0.25)	0.18 (0.13 ~ 0.3)	0.25 (0.2 ~ 0.35)
S 超耐熱合金(湿式) Superalloy (Wet) (Inconel 718) チタン合金(湿式) Titanium Alloy (Wet) (Ti-6Al-4V)	—	30 (15 ~ 50)	0.04 (0.02 ~ 0.06)	0.06 (0.03 ~ 0.1)	0.08 (0.04 ~ 0.12)	0.1 (0.06 ~ 0.14)
	—	60 (30 ~ 100)	0.06 (0.04 ~ 0.08)	0.08 (0.06 ~ 0.12)	0.1 (0.08 ~ 0.15)	0.12 (0.1 ~ 0.15)

- この切削条件基準表は、水溶性切削油剤を使用する場合のものです。
- 水溶性切削油剤は、希釈倍率20倍以下の良質のものをご使用下さい。
- 不水溶性切削油剤は推奨しません。
- この切削条件基準表は、穴深さ3D以下の場合に適用下さい。
- この切削条件基準表は、実切削速度における一般的な値を示したものです。加工環境に合わせて適宜調整して下さい。
- インサート装着に際しては、傷や汚れを取り除いた状態でしっかりと取り付けして下さい。
- 被削材の保持はしっかりと行い、変形、たわみ、振動が起こらない状態にして下さい。
- オイルホールの詰まりは折損トラブルの原因になります。給油装置のフィルタは必ず装着して下さい。

- The indicated speeds and feeds are for using water-soluble oil.
- Suitable cutting fluid is water-soluble in high density (less than 20 times dilution).
- Using non-water-soluble oil is not recommended.
- These conditions are for drilling depth less than 3 times the drill diameter.
- The above cutting conditions are to be used as general guidelines. Adjustments may be necessary depending on actual cutting condition.
- Inserts should be attached to the holder tightly in a very neat condition.
- Fasten the work material to reduce the possibility of work deformation, deflection of machined surface, or vibration.
- A clogged oil hole can lead to a breakage. Make sure that a filter is attached to the oil feeder.

Cutting Data

■加工データ Cutting Data

Inconel 718 (28HRC) の高効率加工 High efficiency machining of Inconel 718 (28HRC)

使用工具 Tool	PHP200FS25M06-3D (φ20)
使用インサート(材種) Insert (grade)	SCMT062806-DM (XP9040)
被削材 Work Material	Inconel 718 (28HRC)
切削速度 Cutting Speed	60m/min (955min ⁻¹)
送り速度 Feed	57mm/min (0.06mm/rev)
穴深さ Depth of Hole	50mm (2.5D 通り) (Through)
切削油剤 Coolant	水溶性切削油剤(内部給油) Water-Soluble (Internal)
使用機械 Machine	複合加工機(ワーク回転) Multifunction milling machine (rotating workpiece)

Inconel 718 (28HRC)の旋盤での穴加工において10穴加工を行ったが切りくずは細かく分断され安定した加工が可能であった。

While drilling holes in Inconel 718 (28HRC) on a lathe, 10 holes were completed, breaking up chips into small pieces and resulting in stable milling.

インサート摩耗幅の写真(5穴加工時点) Photo of insert wear width (after 5 holes)

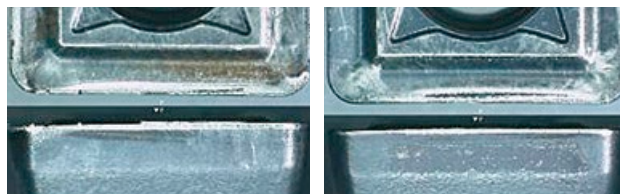

0.147mm

0.113mm

切りくず Chips



SS400の重ね板加工 Stacked milling of SS400

使用工具 Tool	PHP260FS32M08-3D (φ26)	他社品(ハイスドリル) Competitor (HSS Drill)
使用インサート(材種) Insert (grade)	SCMT083608-DM (XP9040)	-
被削材 Work Material	SS400	
切削速度 Cutting Speed	80m/min (980min ⁻¹)	20m/min (245min ⁻¹)
送り速度 Feed	118mm/min (0.12mm/rev)	25mm/min (0.1mm/rev)
穴深さ Depth of Hole	30mm(厚さ20mm×10mm 通り) (Thickness Through)	
切削油剤 Coolant	水溶性切削油剤(外部給油) Water-Soluble (External)	
使用機械 Machine	立形マシニングセンタ(BT50) Vertical Machining Center	

厚さ20mm×10mmの重ね板加工。これまでに他社インデキサブルドリルをテストするもインサート欠損、ボディ破損が多発。インデキサブル化を断念し、ハイスドリルにて低速で加工を行っていたが、PHPでは抜け際で発生するディスクが出来にくい先端角形状のため外部給油にも関わらず安定した加工が可能であった。

Stacked milling consisted of 20mm × 10mm sheets. In the past, tests using a competitor's indexable drills resulted in the frequent breakage of inserts and bodies. Therefore, high-speed drills at low speeds were used instead of indexable drills. Because the chip of the PHP is shaped with an angle, it suppresses the creation of discs, allowing it to mill in a stable manner even when coolant was fed externally.

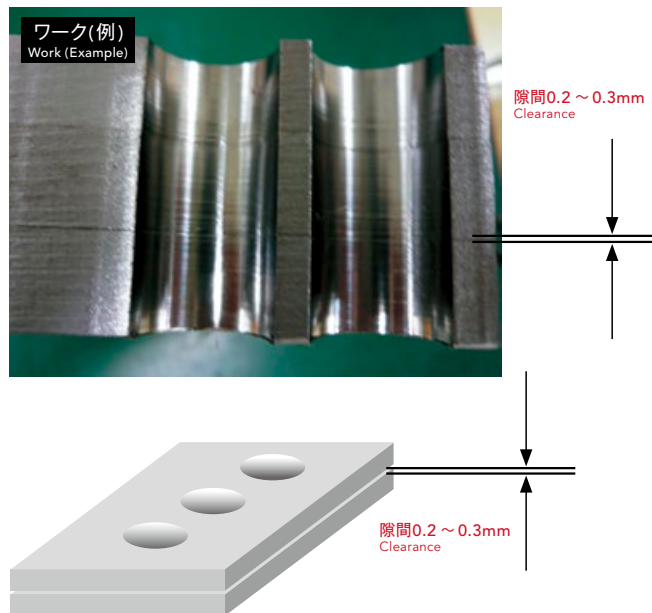

15° 傾斜面の加工 Milling of a 15° inclined plane

使用工具 Tool	PHP210FS25M07-3D (φ21)	他社品A、B Competitor
使用インサート(材種) Insert (grade)	SCMT073206-DM (XP9040)	超硬コーティングインサート Coated Carbide Insert
被削材 Work Material	S50C	
切削速度 Cutting Speed	200m/min (3,033min ⁻¹)	
送り速度 Feed	364mm/min (0.12mm/rev) [入口: 152mm/min (0.05mm/rev)]	
穴深さ Depth of Hole	45mm	
切削油剤 Coolant	水溶性切削油剤 Water-Soluble	
使用機械 Machine	横形マシニングセンタ (BT50) Horizontal Machining Center	



15° 傾斜面加工において、他社品では穴の入口付近にバタつき、口元が拡がってしまっていた(青丸部分)。PHPには連続加工に耐えられる剛性があるため口元の拡がりを抑えている(赤丸部分)。

When milling a 15° inclined plane, a competitor's product wobbled at entry and enlarged the hole entry (as indicated by the blue circle). Because the PHP has the rigidity to withstand intermittent milling, it inhibits the enlargement of the hole entry (as indicated by the red circle).

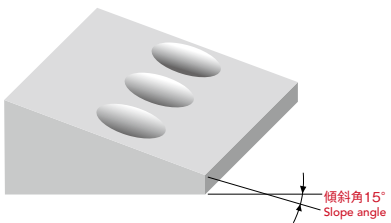

風力発電(旋回輪)の穴加工 Drilling holes in a wind power generator (rotating wheel)

使用工具 Tool	PHP210FS25M07-3D (φ21)	他社品 Competitor
使用インサート(材種) Insert (grade)	SCMT073206-DM (XP9040)	超硬コーティングインサート Coated Carbide Insert
被削材 Work Material	S45C 相当品 Equivalent	
切削速度 Cutting Speed	165m/min (2,502min ⁻¹)	
送り速度 Feed	300mm/min (0.12mm/rev)	
穴深さ Depth of Hole	57mm	
切削油剤 Coolant	水溶性切削油剤 Water-Soluble	
使用機械 Machine	横形専用加工機 Horizontal Dedicated Machine	



他社品の耐久の1.3倍となる、128穴の加工を行ったが安定した加工が可能であった。
The PHP drilled 128 holes and exhibited stable milling performance. Its durability was 1.3 times that of a competitor's product.

部品の穴加工 Drilling holes in parts

使用工具 Tool	PHP210FS25M07-3D (φ21)	他社品 Competitor
使用インサート(材種) Insert (grade)	SCMT073206-DM (XP9040)	超硬コーティングインサート Coated Carbide Insert
被削材 Work Material	SUS304	
切削速度 Cutting Speed	150m/min (2,275min ⁻¹)	
送り速度 Feed	272mm/min (0.12mm/rev)	
穴深さ Depth of Hole	50mm	
切削油剤 Coolant	水溶性切削油剤 Water-Soluble	
使用機械 Machine	横形マシニングセンタ (BT50) Horizontal Machining Center	

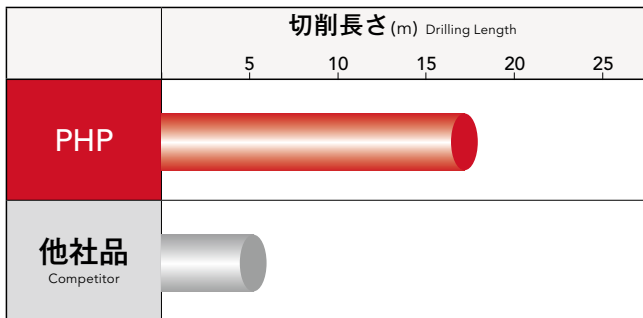

他社品ではチッピングなどで耐久が安定しなかったが、PHPは細かい切りくずと高い排出性により耐久のばらつきを抑制し、他社品の2倍の耐久が得られた。
A competitor's product could not provide stable durability due to chipping. Our product, however, breaks up chips into small pieces and evacuates them properly, which inhibits durability variances and provides double the durability.

Phoenix PDZ

インデキサブルフラットドリル
Indexable Flat Drill

Phoenix Indexable Flat Drill



■安定した穴底フラット加工を実現 Achieves stable flat-bottom hole machining



底刃フラット設定 Flat bottom cutting edge configuration

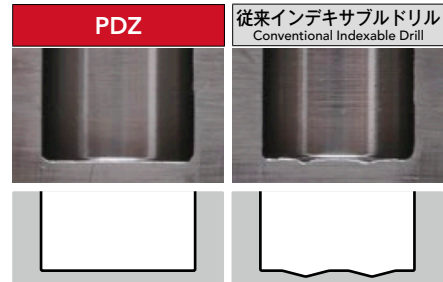

穴底形状イメージ Bottom Hole Shape Comparison
φ20 被削材：S50C
Work material

穴加工をはじめ、座ぐり穴、傾斜面加工など多様な用途に対応

Compatible with a wide range of applications including drilling, counterboring, inclined surface drilling, and more.

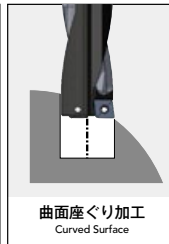
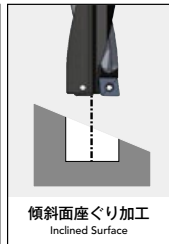

良好な切りくず排出性 Good chip evacuation

剛性を高める溝設計に高精度仕上げをプラスすることで切りくず排出性をさらにアップ!

High precision finishing on flute improves rigidity, chip ejection and reduces cutting force!

穴加工で高い切りくず分断性

Superior chip breaking capability during drilling, counterboring, and turning



切れ刃に対して大きく盛り上がったマッスルブレーカで抜群の切りくず分断性を実現

Excellent chip breaking capability with the enhanced muscle breaker

・座ぐりカッタPZAG、多機能カッタシリーズPMDと共通インサートを採用

・外周刃と中心刃に同一インサートを使用することで4コーナ使用でき経済的*

*外周刃として2コーナ、中心刃として2コーナの計4コーナ

・ Uses the same insert as the PZAG counterboring cutter and the PMD multi-function cutter series

・ Economical 4-corner insert design maximizes cost efficiency, with the same insert applicable to both peripheral and center cutting edge*

*2 corners for the peripheral cutting edge and 2 corners for the center cutting edge, adding up to a total of 4 corners.

φ20 穴加工(ノンステップ加工)
φ20 hole processing (non-step drilling)

被削材：S50C 切削条件：Vc=150m/min、f=0.1mm/rev
Work Material Cutting Conditions

インサート装着時の注意事項についてはP.63をご覧ください。
See page 63 for precautions when installing the inserts.

■ヘッド交換式ドリルと比較して高いコストパフォーマンス

Higher cost performance compared to exchangeable head drills

PDZは4コーナあたりの加工穴数を、他社品はヘッド1個あたりの加工穴数を示します。
 The number of holes machined per insert corner by the PDZ versus per exchangeable head by a competitor.

使用工具 Tool	PDZ1600FS20M05-2D (φ16)	他社ヘッド交換式ドリル Competitor Exchangeable Head Drill
使用インサート(材種) Insert (grade)	ZPNT050204EN (XP8030)	-
被削材 Work Material	S50C	
切削速度 Cutting Speed	150m/min (2,984min ⁻¹)	100m/min (1,989min ⁻¹)
送り速度 Feed	298mm/min (0.1mm/rev)	198mm/min (0.1mm/rev)
穴深さ Depth of Hole	24mm(止り) (Blind)	
切削油剤 Coolant	水溶性切削油剤(内部給油) Water-Soluble (Internal)	
使用機械 Machine	横形マシニングセンタ(BT50) Horizontal Machining Center	

	加工穴数 Number of Holes			
	880	1,760	2,640	3,520
PDZ	1コーナ目 1st corner	2コーナ目 2nd corner	3コーナ目 3rd corner	4コーナ目 4th corner
他社品 Competitor				

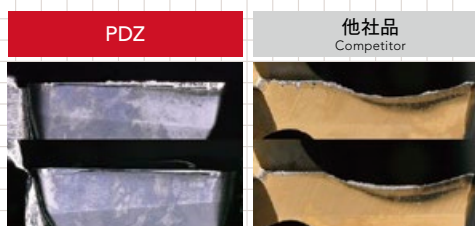

■豊富なラインナップ Broad size lineup

キャップボルトの座ぐり穴寸法規格に合わせたサイズラインナップ (ボルトねじサイズM10 ~ M27に対応)
 Size lineup corresponding to the cap bolt's counterbore hole size (corresponds to bolt screw sizes M10 to M27)



※正面フライス(横引き加工)としては使用できません。
 Cannot be used as a face milling cutter

DCがドリル外径となります
 DC* represents the drill diameter

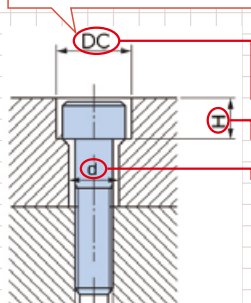

■六角穴付きボルトに対する座ぐり及びボルト穴の寸法

Dimensions of counterbore and bolt hole with hexagon socket head bolt

ねじの呼び Thread size	M10	M12	M14	M16	M18	M20	M22	M24	M27
DC	17.5	20	23	26	29	32	35	39	43
H	10.8	13	15.2	17.5	19.5	21.5	23.5	25.5	29
d	11	14	16	18	20	22	24	26	30

単位:mm Unit:mm

■旋盤での工具集約も実現 Enables tool consolidation on lathes

旋削加工の事例はP.67へ
 See page 67 for turning example

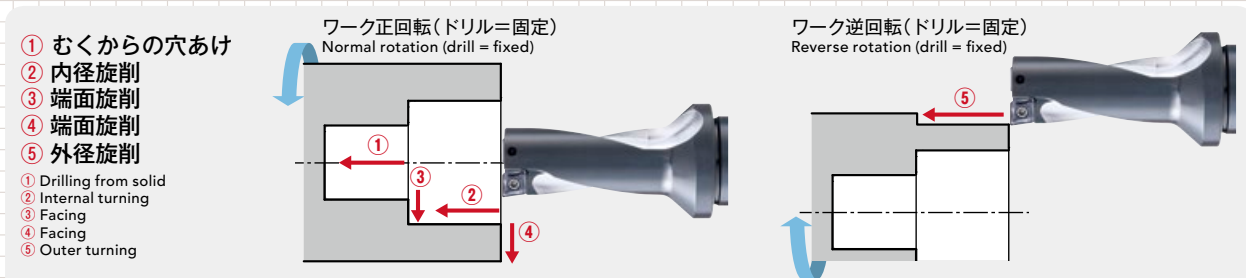

5つの加工を1本で対応します 1 tool for 5 types of machining method

Phoenix

インデキサブルフラットドリル

Indexable Flat Drill

PDZ

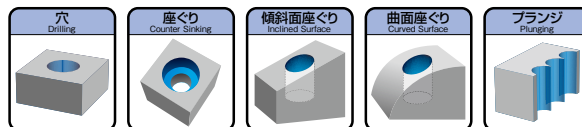

Specification

■形状寸法表 Specification

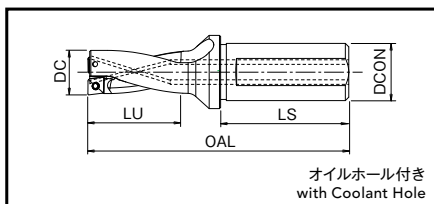

2Dタイプ 2D Type

単位:mm Unit:mm

ツールNo. EDP No.	呼び Designation	外径 DC	全長 OAL	有効加工長さ LU	シャンク径 DCON	シャンク長 LS	適用インサート Applicable Inserts	標準価格 (Yen)
7803776	PDZ1600FS20M05-2D	16	97	32	20	50	①	41,700
7803777	PDZ1650FS20M05-2D	16.5	98	33	20	50		41,700
7803778	PDZ1700FS20M05-2D	17	102	34	20	50		41,700
7803779	PDZ1750FS25M05-2D	17.5	109	35	25	56		41,700
7803780	PDZ1800FS25M05-2D	18	110	36	25	56		41,700
7803781	PDZ1850FS25M05-2D	18.5	111	37	25	56		41,700
7803782	PDZ1900FS25M06-2D	19	112	38	25	56	②	41,700
7803783	PDZ1950FS25M06-2D	19.5	113	39	25	56		41,700
7803784	PDZ2000FS25M06-2D	20	114	40	25	56		41,700
7803785	PDZ2100FS25M06-2D	21	121	42	25	56	③	41,700
7803786	PDZ2200FS25M06-2D	22	123	44	25	56		41,700
7803787	PDZ2300FS25M07-2D	23	125	46	25	56		41,700
7803788	PDZ2400FS25M07-2D	24	127	48	25	56	④	41,700
7803789	PDZ2500FS25M07-2D	25	129	50	25	56		46,300
7803790	PDZ2500FS32M07-2D	25	133	50	32	60		46,300
7803791	PDZ2600FS32M07-2D	26	135	52	32	60	⑤	46,300
7803792	PDZ2700FS32M08-2D	27	137	54	32	60		46,300
7803793	PDZ2800FS32M08-2D	28	139	56	32	60		46,300
7803794	PDZ2900FS32M08-2D	29	141	58	32	60	⑥	54,300
7803795	PDZ3000FS32M08-2D	30	143	60	32	60		54,300
7803796	PDZ3100FS32M08-2D	31	145	62	32	60		54,300
7803797	PDZ3200FS32M09-2D	32	147	64	32	60	⑦	54,300
7803798	PDZ3300FS40M09-2D	33	159	66	40	70		54,300
7803799	PDZ3400FS40M09-2D	34	161	68	40	70		60,000
7803800	PDZ3500FS40M10-2D	35	163	70	40	70	⑧	60,000
7803801	PDZ3600FS40M10-2D	36	165	72	40	70		60,000
7803802	PDZ3700FS40M10-2D	37	167	74	40	70		60,000
7803803	PDZ3800FS40M10-2D	38	169	76	40	70		60,000
7803804	PDZ3900FS40M13-2D	39	178	78	40	70	⑨	68,200
7803805	PDZ4000FS40M13-2D	40	180	80	40	70		68,200
7803806	PDZ4100FS40M13-2D	41	182	82	40	70		68,200
7803807	PDZ4200FS40M13-2D	42	184	84	40	70		68,200
7803808	PDZ4300FS40M13-2D	43	186	86	40	70		68,200

青字=キャップボルト座ぐり対応サイズ Items in blue = cap bolt counterbore compatible size

ねじの呼びに対応した推奨下穴径はp.16をご参照下さい。

Please see p.16 for recommended tap pilot hole size.

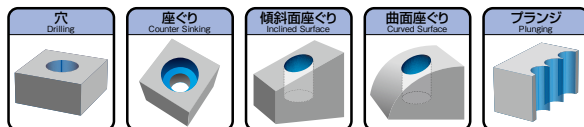

■形状寸法表 Specification

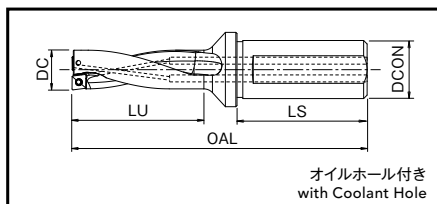

3Dタイプ 3D Type

単位:mm Unit:mm

ツールNo. EDP No.	呼び Designation	外径 DC	全長 OAL	有効加工深さ LU	シャンク径 DCON	シャンク長 LS	適用インサート Applicable Inserts	標準価格 (Yen)
7803828	PDZ1600FS20M05-3D	16	113	48	20	50	①	47,100
7803829	PDZ1650FS20M05-3D	16.5	115	49.5	20	50		47,100
7803830	PDZ1700FS20M05-3D	17	119	51	20	50		47,100
7803831	PDZ1750FS25M05-3D	17.5	127	52.5	25	56		47,100
7803832	PDZ1800FS25M05-3D	18	128	54	25	56		47,100
7803833	PDZ1850FS25M05-3D	18.5	130	55.5	25	56		47,100
7803834	PDZ1900FS25M06-3D	19	131	57	25	56	②	47,100
7803835	PDZ1950FS25M06-3D	19.5	133	58.5	25	56		47,100
7803836	PDZ2000FS25M06-3D	20	134	60	25	56		47,100
7803837	PDZ2100FS25M06-3D	21	142	63	25	56	③	47,100
7803838	PDZ2200FS25M06-3D	22	145	66	25	56		47,100
7803839	PDZ2300FS25M07-3D	23	148	69	25	56		47,100
7803840	PDZ2400FS25M07-3D	24	151	72	25	56	④	47,100
7803841	PDZ2500FS25M07-3D	25	154	75	25	56		52,200
7803842	PDZ2500FS32M07-3D	25	158	75	32	60		52,200
7803843	PDZ2600FS32M07-3D	26	161	78	32	60	⑤	52,200
7803844	PDZ2700FS32M08-3D	27	164	81	32	60		52,200
7803845	PDZ2800FS32M08-3D	28	167	84	32	60		52,200
7803846	PDZ2900FS32M08-3D	29	170	87	32	60	⑥	60,400
7803847	PDZ3000FS32M08-3D	30	173	90	32	60		60,400
7803848	PDZ3100FS32M08-3D	31	176	93	32	60		60,400
7803849	PDZ3200FS32M09-3D	32	179	96	32	60	⑦	60,400
7803850	PDZ3300FS40M09-3D	33	192	99	40	70		60,400
7803851	PDZ3400FS40M09-3D	34	195	102	40	70		63,900
7803852	PDZ3500FS40M10-3D	35	198	105	40	70	⑧	63,900
7803853	PDZ3600FS40M10-3D	36	201	108	40	70		63,900
7803854	PDZ3700FS40M10-3D	37	204	111	40	70		63,900
7803855	PDZ3800FS40M10-3D	38	207	114	40	70	⑨	63,900
7803856	PDZ3900FS40M13-3D	39	217	117	40	70		72,500
7803857	PDZ4000FS40M13-3D	40	220	120	40	70		72,500
7803858	PDZ4100FS40M13-3D	41	223	123	40	70	⑩	72,500
7803859	PDZ4200FS40M13-3D	42	226	126	40	70		72,500
7803860	PDZ4300FS40M13-3D	43	229	129	40	70		72,500

青字 = キャップボルト座ぐり対応サイズ Items in blue = cap bolt counterbore compatible size

ねじの呼びに対応した推奨下穴径はp.16をご参照下さい。

Please see p.16 for recommended tap pilot hole size.

在庫区分は全てC(標準在庫品)となります。 Stock are categorized as C (Standard stock item).

Phoenix

インデキサブルフラットドリル

Indexable Flat Drill

PDZ

Inserts

■形状寸法表 Specification

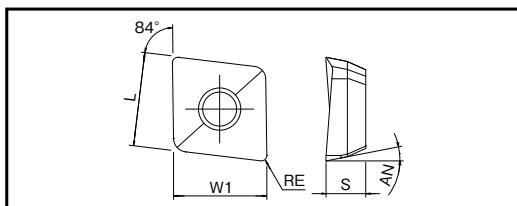

■適用インサート Applicable Inserts

単位:mm Unit:mm

呼び Designation	インサート寸法 Insert Size				適用ボディ Applicable Body	コーティング材種 Carbide Coated Materials	標準価格 (Yen)
	L × W1	厚さ S	逃げ角 AN	RE		XP8030	
① ZPNT050204EN	5.9 × 5.9	2.25	11°	0.4	φ16 ~ 18.5	7814102	1,850
② ZPNT060204EN	6.95 × 6.95	2.93	11°	0.4	φ19 ~ 22	7814103	1,900
③ ZPNT070304EN	7.84 × 7.84	3.87	11°	0.4	φ23 ~ 26	7814104	1,900
④ ZPNT080304EN	8.85 × 8.85	3.92	11°	0.4	φ27 ~ 31	7814105	1,920
⑤ ZPNT090404EN	9.94 × 9.94	4.65	11°	0.4	φ32 ~ 34	7814106	1,930
⑥ ZPNT100408EN	10.95 × 10.95	4.65	11°	0.8	φ35 ~ 38	7814108	2,030
⑦ ZPNT130508EN	13.92 × 13.92	5.46	11°	0.8	φ39 ~ 43	7814110	2,350

さらなる耐久性を求める加工には外周刃に専用インサートを選定下さい。

For machining that requires greater durability, select a designated insert for the peripheral cutting edge.

■PDZ外周刃専用インサート Inserts for Peripheral Cutting Edge

※PDZ外周刃専用インサートは中心刃に取り付けしないで下さい。

* Do not attach inserts dedicated for the PDZ peripheral cutting edge to the center cutting edge.

単位:mm Unit:mm

呼び Designation	インサート寸法 Insert Size				適用ボディ Applicable Body	コーティング材種 Carbide Coated Materials	標準価格 (Yen)
	L × W1	厚さ S	逃げ角 AN	RE		XC8035	
① ZPNT050204EN	5.9 × 5.9	2.25	11°	0.4	φ16 ~ 18.5	7815102	1,850
② ZPNT060204EN	6.95 × 6.95	2.93	11°	0.4	φ19 ~ 22	7815103	1,900
③ ZPNT070304EN	7.84 × 7.84	3.87	11°	0.4	φ23 ~ 26	7815104	1,900
④ ZPNT080304EN	8.85 × 8.85	3.92	11°	0.4	φ27 ~ 31	7815105	1,920
⑤ ZPNT090404EN	9.94 × 9.94	4.65	11°	0.4	φ32 ~ 34	7815106	1,930
⑥ ZPNT100408EN	10.95 × 10.95	4.65	11°	0.8	φ35 ~ 38	7815108	2,030
⑦ ZPNT130508EN	13.92 × 13.92	5.46	11°	0.8	φ39 ~ 43	7815110	2,350



インサート装着時の注意

Precautions when installing the insert

・インサート(XP8030)は外周刃として2コーナ、中心刃として2コーナの計4コーナ使用できます。
The insert (XP8030) has a total of 4 working corners – 2 corners for the peripheral cutting edge and 2 corners for the center cutting edge.

・外周刃には外周刃用コーナを、中心刃には中心刃用コーナを使用して下さい。
Use the peripheral cutting edge corner for the peripheral cutting edge and the center cutting edge corner for the center cutting edge.



外周刃装着時
Attached with peripheral cutting edge



中心刃装着時
Attached with center cutting edge



—: 外周刃用切れ刃
Edges for peripheral cutting

—: 中心刃用切れ刃
Edges for center cutting

Accessories

■部品 Accessories

	ツールNo. EDP No.	呼び Designation	適用インサート Applicable Inserts	適用ボディ Applicable Body	推奨締め付けトルク Recommended Tightening Torque
 クランプねじ Clamping Screw	7808139	FS20543P (Torx 6IP)	① ZPNT05...	PDZ φ16~18.5	0.7 N·m
	7808138	FS22550P (Torx 7IP)	② ZPNT06...	PDZ φ19~22	1.0 N·m
	7808136	FS25560P (Torx 8IP)	③ ZPNT07...	PDZ φ23~26	1.6 N·m
	7808135	FS30570P (Torx 9IP)	④ ZPNT08...	PDZ φ27~34	2.2 N·m
			⑤ ZPNT09...		
	7808137	FS35586P (Torx 15IP)	⑥ ZPNT10...	PDZ φ35~38	3.2 N·m
	7808114	FS45510P (Torx 20IP)	⑦ ZPNT13...	PDZ φ39~43	5.0 N·m

	ツールNo. EDP No.	呼び Designation	適用インサート Applicable Inserts	適用ボディ Applicable Body	標準価格 (Yen)
 レンチ Wrench	7808223	6IP-D (Torx 6IP)	① ZPNT05...	PDZ φ16~18.5	1,600
	7808224	7IP-D (Torx 7IP)	② ZPNT06...	PDZ φ19~22	1,370
	7808225	8IP-D (Torx 8IP)	③ ZPNT07...	PDZ φ23~26	1,560
	7808226	9IP-D (Torx 9IP)	④ ZPNT08...	PDZ φ27~34	1,600
			⑤ ZPNT09...		
	7808228	15IP-D (Torx 15IP)	⑥ ZPNT10...	PDZ φ35~38	1,820
	7808229	20IP-D (Torx 20IP)	⑦ ZPNT13...	PDZ φ39~43	1,930

在庫区分は全てC(標準在庫品)となります。 Stock are categorized as C (Standard stock item).

レンチは別途ご購入下さい。
The wrenches are sold separately from the cutters.

⚠️ むくからの穴あけ時の注意 Precautions when drilling from solid

オフセット加工は推奨しません。

PDZはインサート配列の都合上、オフセット加工を行うと中心刃インサートに欠けが発生します。

Offset machining is not recommended.

Due to the insert arrangement of the PDZ, chipping will occur in the center insert when offset machining is performed.

調整が必要な穴加工には、PDドリル*を選定下さい(p.33参照)。

Select the PD drill* for drilling that requires adjustment (refer to p.33).

*PDドリルは穴底がフラットになりません。

*PD drill does not make the bottom of the hole flat.

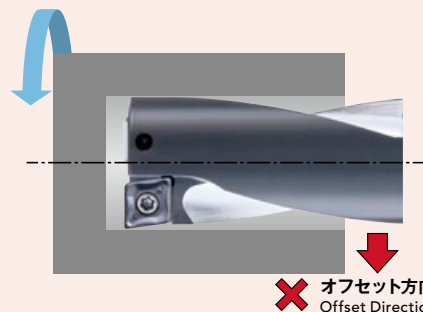

❌ オフセット方向
Offset Direction

■被削材別推奨材質

Recommended Materials by Insert Type

◎第一推奨材質 Best
○第二推奨材質 Good

インサート材種 Insert Grades	切削油剤 Coolant	P	M	K	N	S	H
XP8030	有 Wet	◎	◎	○	○	○	○

■外周刃専用インサート

Inserts for Peripheral Cutting Edge

◎第一推奨材質 Best
○第二推奨材質 Good

インサート材種 Insert Grades	切削油剤 Coolant	P	M	K	N	S	H
XC8035	無 Dry	○	◎				
	有 Wet		○				

Cutting Conditions

■切削条件基準表 Cutting Conditions

被削材 Work Material	引張強さ・硬さ Tensile Strength・Hardness	切削速度 Vc (m/min) Cutting Speed	送り量 f (mm/rev) Feed Rate						
			φ16~φ16.5	φ17~φ18.5	φ19~φ20	φ21~φ24	φ25~φ28	φ29~φ33	φ34~φ43
P 軟鋼、低炭素鋼 Mild Steel, Carbon Steel (S5400, S10C) 炭素鋼、合金鋼 Carbon Steel, Alloy Steel (S50C, SCM440) ダイス鋼 Die Steel (SKD11, SKD61)	~180HB	200(150~250)	0.06 (0.04~0.1)	0.06 (0.04~0.1)	0.07 (0.04~0.1)	0.08 (0.04~0.12)	0.08 (0.04~0.12)	0.1 (0.05~0.15)	0.1 (0.05~0.18)
	~280HB	150(100~220)	0.08 (0.04~0.14)	0.09 (0.04~0.16)	0.1 (0.04~0.18)	0.14 (0.04~0.2)	0.18 (0.06~0.25)	0.2 (0.08~0.3)	0.2 (0.08~0.35)
	~280HB	120(80~180)	0.06 (0.04~0.1)	0.07 (0.04~0.1)	0.08 (0.04~0.12)	0.12 (0.04~0.15)	0.14 (0.06~0.2)	0.18 (0.08~0.25)	0.18 (0.08~0.25)
M ステンレス鋼 Stainless Steel (SUS304, SUS420)	~250HB	130(80~180)	0.07 (0.04~0.1)	0.08 (0.04~0.1)	0.09 (0.04~0.12)	0.1 (0.04~0.15)	0.13 (0.06~0.2)	0.15 (0.08~0.25)	0.15 (0.08~0.25)
K 鋳鉄 Cast Iron (FC250) ダクタイル鋳鉄 Ductile Cast Iron (FCD400)	~350N/mm ²	200(150~280)	0.08 (0.04~0.14)	0.1 (0.04~0.16)	0.12 (0.04~0.2)	0.16 (0.08~0.25)	0.2 (0.06~0.3)	0.2 (0.08~0.3)	0.2 (0.08~0.35)
	~800N/mm ²	160(100~220)	0.08 (0.04~0.12)	0.09 (0.04~0.14)	0.1 (0.04~0.18)	0.14 (0.04~0.2)	0.18 (0.06~0.25)	0.18 (0.08~0.25)	0.18 (0.08~0.25)
N アルミニウム合金 Aluminum Alloy	~13%Si	200(100~800)	0.08 (0.04~0.12)	0.1 (0.04~0.16)	0.12 (0.04~0.2)	0.16 (0.04~0.25)	0.2 (0.06~0.3)	0.2 (0.08~0.3)	0.2 (0.08~0.3)
S 超耐熱合金 Superalloy (Inconel718) チタン合金 Titanium Alloy (Ti-6Al-4V)	-	50(15~60)	0.04 (0.02~0.06)	0.05 (0.03~0.06)	0.05 (0.03~0.06)	0.06 (0.04~0.08)	0.08 (0.06~0.1)	0.1 (0.06~0.12)	0.1 (0.06~0.12)
	-	60(30~100)	0.05 (0.04~0.08)	0.06 (0.04~0.08)	0.06 (0.04~0.08)	0.08 (0.04~0.15)	0.1 (0.06~0.2)	0.14 (0.08~0.2)	0.14 (0.08~0.2)
H プリハードン鋼 Pre-hardened Steel (NAK80) 調質鋼 Hardened Steel (SKD11)	40~43HRC	100(60~120)	0.06 (0.04~0.1)	0.06 (0.04~0.12)	0.07 (0.04~0.12)	0.08 (0.04~0.12)	0.1 (0.06~0.15)	0.1 (0.06~0.15)	0.1 (0.06~0.15)
	50~55HRC	60(40~80)	0.05 (0.04~0.08)	0.05 (0.04~0.08)	0.06 (0.04~0.08)	0.06 (0.04~0.08)	0.08 (0.04~0.1)	0.08 (0.04~0.1)	0.08 (0.04~0.1)

■加工穴径の目安値

Reference Value of Hole Diameter

単位:mm Unit:mm

外径 DC	PDZ
φ16~φ20	+0.2 -0.15
φ21~φ43	+0.25 -0.15

上記は推奨条件下での一般的な値を示したものです。加工環境によって異なる場合があります。The above values are general recommendation and may differ based on actual machining condition.

- The indicated speeds and feeds are for using water-soluble oil with inner supply.
- Suitable cutting fluid is water-soluble in high density (less than 20 times dilution).
- Using non-water-soluble oil is not recommended.
- The above cutting conditions are to be used as general guidelines. Adjustments may be necessary depending on actual cutting condition.
- Inserts should be attached to the holder tightly in a very neat condition.
- Fasten the work material to reduce the possibility of work deformation, deflection of machined surface, or vibration.
- A clogged oil hole can lead to a breakage. Make sure that a filter is attached to the oil feeder.

■旋削加工 Turning

内径・外径旋削の切込み/送り条件 Cutting Conditions of Internal / External Turning

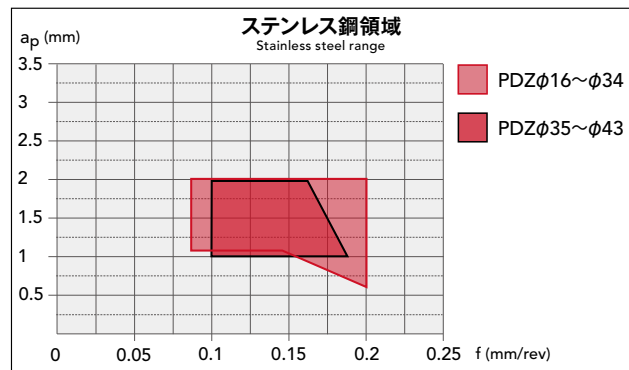
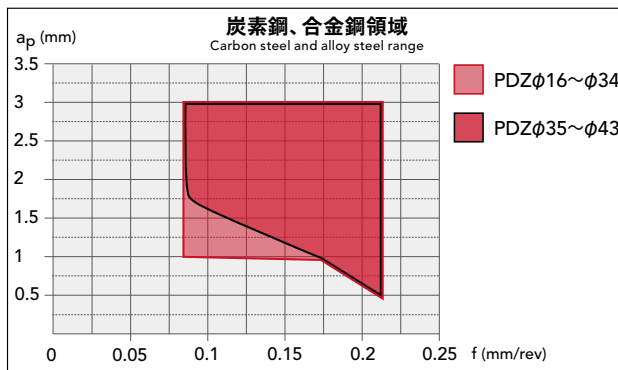

Cutting Data

加工データ Cutting Data

PDZ
加工動画は
こちら
Watch it in action



傾斜面座ぐり加工 Counterboring in Inclined Surfaces

使用工具 Tool	PDZ2500FS25M07-2D (φ25)
使用インサート(材種) Insert (grade)	ZPNT070304EN (XP8030)
被削材 Work Material	S50C
切削速度 Cutting Speed	60m/min (764min ⁻¹)
送り速度 Feed	46mm/min (0.06mm/rev)
座ぐり深さ Counterbore Depth	座ぐり: 25mm 傾斜角度20° Counterboring Slope angle
切削油剤 Coolant	ドライ Dry
使用機械 Machine	横形マシニングセンタ (BT50) Horizontal Machining Center

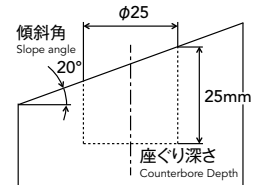

曲面座ぐり加工 Counterboring in Curved Surfaces

使用工具 Tool	PDZ2000FS25M06-2D (φ20)
使用インサート(材種) Insert (grade)	ZPNT060204EN (XP8030)
被削材 Work Material	SCM420
切削速度 Cutting Speed	50m/min (800min ⁻¹)
送り速度 Feed	80mm/min (0.1mm/rev)
座ぐり深さ Counterbore Depth	座ぐり: 10mm Counterboring
切削油剤 Coolant	水溶性切削油剤 (内部給油) Water-Soluble (Internal)
使用機械 Machine	複合旋盤 (HSK-A63) Multifunction Lathe

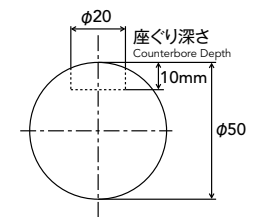

小径の穴加工にも対応

Also supports small diameter drilling

超硬フラットドリル

ADF

Carbide Flat Drill

ラインナップ Lineup

- ADF-2D : φ0.2 ~ φ20
- ADFO-3D : φ3 ~ φ20
- ADFLS-2D : φ3 ~ φ20
- ADF-NC : φ2 ~ φ12
- ADFO-NC : φ3 ~ φ10



詳細はこちら
Scan for details

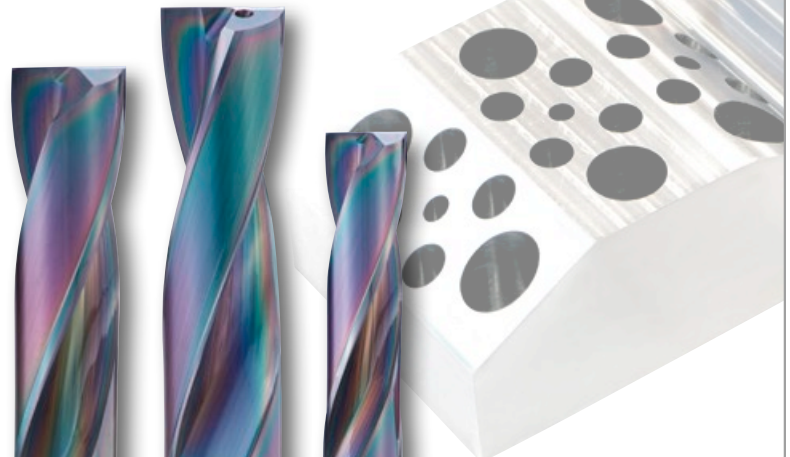

Cutting Data

■加工データ Cutting Data

SUS304においても高いコストパフォーマンス High cost performance even in SUS304

使用工具 Tool	PDZ1600FS20M05-2D (φ16)	他社ヘッド交換式ドリル Competitor Exchangeable Head Drill
使用インサート(材種) Insert (grade)	ZPNT050204EN (XP8030)	-
被削材 Work Material	SUS304	
切削速度 Cutting Speed	80m/min (1,591min ⁻¹)	
送り速度 Feed	80mm/min (0.05mm/rev)	
座ぐり深さ Counterbore Depth	24mm	
切削油剤 Coolant	水溶性切削油剤(内部給油) Water-Soluble (Internal)	
使用機械 Machine	横形マシニングセンタ(BT50) Horizontal Machining Center	

	加工穴数 Number of Holes			
	960	1,920	2,880	3,840
PDZ	1コーナ目 1st corner	2コーナ目 2nd corner	3コーナ目 3rd corner	4コーナ目 4th corner
他社品 Competitor				

PDZは4コーナあたりの加工穴数を、
他社品はヘッド1個あたりの加工穴数を示します。

The number of holes machined per insert corner by the PDZ versus per exchangeable head by a competitor.



旋削加工で工具集約 Tool consolidation by turning

使用工具 Tool	PDZ2500FS25M07-2D (φ25)	
使用インサート(材種) Insert (grade)	ZPNT070304EN (XP8030)	
被削材 Work Material	SCM440	
切削方法 Milling Method	穴あけ加工 Drilling	内径繰り広げ加工 Contouring
切削速度 Cutting Speed	100m/min (1,273min ⁻¹)	100m/min
送り速度 Feed	127mm/min (0.1mm/rev)	f=0.12mm/rev ap=2mm×4パス Pass
切削油剤 Coolant	エアブロー Air Blow	
使用機械 Machine	複合旋盤(HSK-A63) Multifunction Lathe	

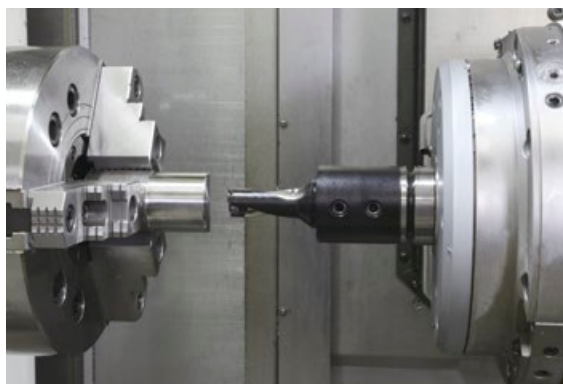

加工ワーク Workpiece

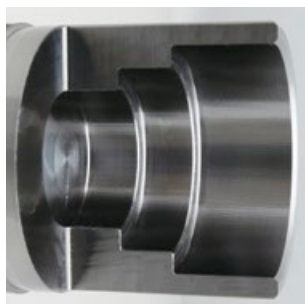

傾斜面座ぐり加工 Counterboring in inclined surfaces

使用工具 Tool	PDZ1800FS25M05-3D (φ18)	
使用インサート(材種) Insert (grade)	ZPNT050204EN (XP8030)	
被削材 Work Material	S50C	
切削速度 Cutting Speed	60m/min (1,062min ⁻¹)	
送り速度 Feed	42mm/min (0.04mm/rev)	
座ぐり深さ Counterbore Depth	座ぐり: 40mm 傾斜角度30° Counterboring Slope angle	
切削油剤 Coolant	水溶性切削油剤(内部給油) Water-Soluble (Internal)	
使用機械 Machine	立形マシニングセンタ(BT40) Vertical Machining Center	

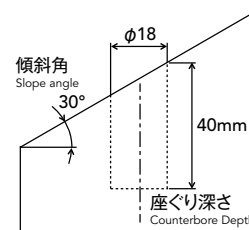

傾斜面座ぐり加工において、良好な口元形状であり安定した穴品位が得られた。

Good hole shape and stable hole quality were obtained in the counterboring of inclined surface.

NC旋盤での座ぐり加工 Counterboring on NC lathe

使用工具 Tool	PDZ1600FS20M05-3D (φ16)	他社品 Competitor
使用インサート(材種) Insert (grade)	ZPNT050204EN (XP8030)	超硬コーティングインサート Coated Carbide Insert
被削材 Work Material	S45C	
切削速度 Cutting Speed	150m/min (2,986min ⁻¹)	
送り速度 Feed	239mm/min (0.08mm/rev)	
座ぐり深さ Counterbore Depth	48mm	
切削油剤 Coolant	水溶性切削油剤(内部給油) Water-Soluble (Internal)	
使用機械 Machine	複合加工機 Compound Machine	



NC旋盤での座ぐり加工において、他社品は振動が発生し加工面が悪化、PDZは、安定加工により良好な加工面が得られた。

When counterboring on a NC lathe, vibration occurred with the competitor product and the machined surface deteriorated. The PDZ, on the other hand, demonstrated stable machining and achieved good machined surface.

干渉物のある突出し長さ3Dの加工 3D overhang length machining with interference

使用工具 Tool	PDZ2200FS25M06-3D (φ22)	他社ヘッド交換式ドリル Competitor Exchangeable Head Drill
使用インサート(材種) Insert (grade)	ZPNT060204EN (XP8030)	-
被削材 Work Material	FC250	
切削速度 Cutting Speed	150m/min (2,170min ⁻¹)	70m/min (1,013min ⁻¹)
送り速度 Feed	260mm/min (0.12mm/rev)	182mm/min (0.18mm/rev)
穴深さ Depth of Hole	35mm	
切削油剤 Coolant	水溶性切削油剤(内部給油) Water-Soluble (Internal)	
使用機械 Machine	立形マシニングセンタ(BT50) Vertical Machining Center	

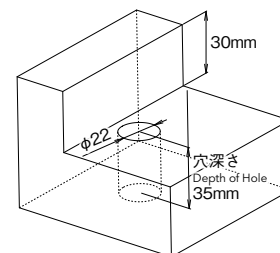

干渉物のある加工深さ35mm (1.6D)の穴加工。干渉回避のためPDZの3Dタイプを用いて加工を行った。ドリル本体の高い剛性で、他社ヘッド交換式ドリルと比較して高い条件で加工できた。

Drilling at a depth of 35 mm (1.6D) with interference. The PDZ 3D type was used to avoid interference. Due to the high rigidity of the drill body, it was possible to machine at a more aggressive cutting condition than the competitor's exchangeable head drill.

インデキサブルドリルのご紹介

Introduction of indexable drills

豊富なラインナップで幅広い径の穴加工に対応します。

A vast drilling lineup with a wide range of diameter sizes.

» **PXD** ヘッド交換式ドリル3D/5D
Exchangeable Head Drill for 3D, 5D

- 独自の方式で強固な締結
OSG's proprietary construction ensures secure mounting
- 内部給油により高効率加工が可能
Internal coolant capability enables highly efficient drilling
- スムーズな切りくず排出性
Smooth chip evacuation



P.17~

» **PD** インデキサブルドリル
Indexable Drill

- 外周・中心に同一インサートを使用
The same insert is used for both the peripheral and center cutting edge
- 2D~5Dまで対応
Supports 2 x D up to 5 x D
- 豊富なラインナップ
Extensive lineup



P.33~

» **PHP** インデキサブルドリル3D用
Indexable Drill for 3D

- 独自の形状で様々な加工形態に対応
Unique design supports many types of drilling
- 傾斜面 鋳肌面 重ね板
Inclined plane Cast surface Stacked plates
- 高剛性ボディ
High rigidity of body



P.53~

» **PDZ** インデキサブルフラットドリル
Indexable Flat Drill

- 2D/3Dタイプ
2D/3D Type
- 底刃フラット設定
Flat bottom cutting edge configuration
- 良好な切りくず排出性
Good chip evacuation
- 穴加工で高い切りくず分断性
Superior chip breaking capability during drilling, counterboring, and turning



P.59~

■製品別対応加工深さ Drilling depth by product

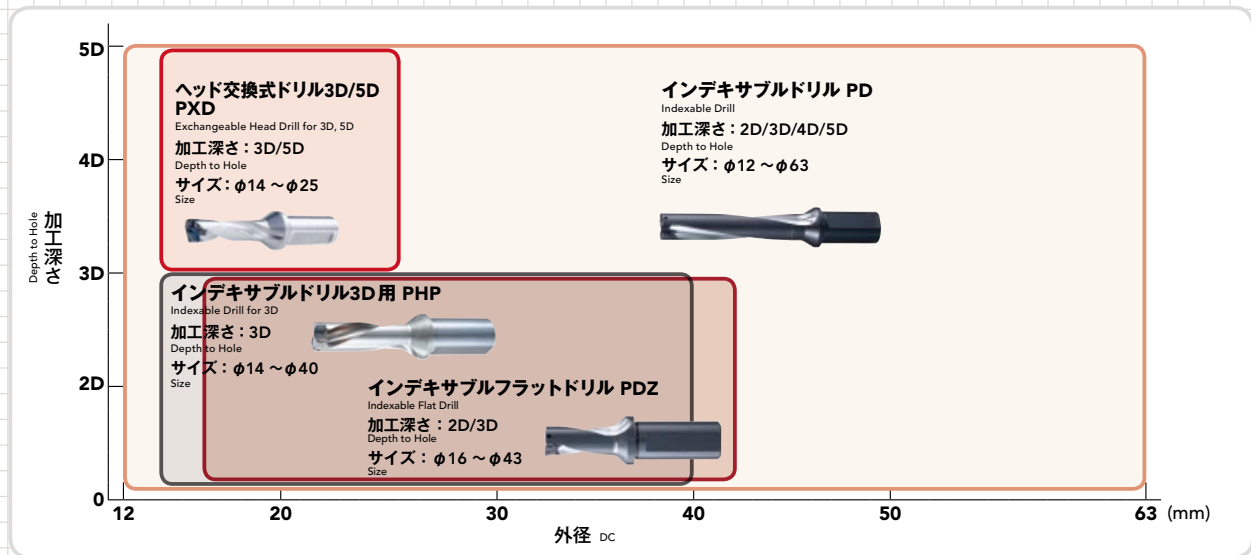

フラット穴加工が可能な製品ラインナップのご紹介

Introduction of product lineup capable of flat-bottom hole machining

加工ニーズに合わせて3製品をご用意しています。

3 product offering to meet your machining needs

» **PZAG** 座ぐりカッタ
Counterboring Cutter

- 切りくず分断性を追求した座ぐりカッタ
Counterboring cutter with perfect chip control
- 豊富なラインナップ
Broad size lineup



P.71~

» **PMD** 多機能カッタシリーズ
Multi-function Cutter Series

- 1本で多様な加工形態に対応
Supports a wide range of applications with a single tool
- 2種類のインサートを使用することで突込み→横引きの連続加工が可能
Two types of inserts are used to enable continuous cutting - from plunging to horizontal milling



P.145~

» **PDZ** インデキサブルフラットドリル
Indexable Flat Drill

- 2D/3Dタイプ
2D/3D Type
- 底刃フラット設定
Flat bottom cutting edge configuration
- 良好な切りくず排出性
Good chip evacuation
- 穴加工で高い切りくず分断性
Superior chip breaking capability during drilling, counterboring, and turning



P.59~

■各製品の特長 Features of each product

	PZAG	PMD	PDZ
形状 Shape	座ぐりカッタ Counterboring Cutter	多機能カッタ Multi-function Cutter	インデキサブルフラットドリル Indexable Flat Drill
穴底形状 Bottom hole shape		フラット Flat	
穴加工能率 Drilling efficiency	◎	△	○
穴あけ加工時の下穴の要否 Requirement of pilot hole when drilling	要 Required	不要 Not required	不要 Not required
横引き Horizontal Milling	-	○	-
使用インサート呼び Insert designation	ZPNT...	底刃用: ZPNT... for Drilling and Plunging Edge 外周刃用: ZDKT... for Peripheral Cutting Edge	ZPNT...

共通のインサートを使用しているため工具管理も容易!
Simple tool management with interchangeable inserts!

» Phoenix PZAG

座ぐりカッタ
Counterboring Cutter

Phoenix Counterboring Cutter

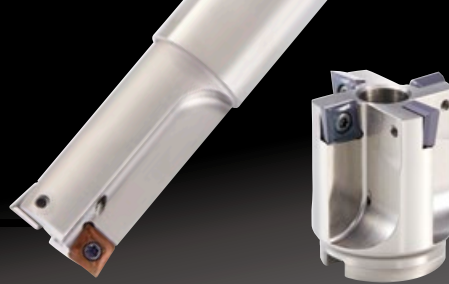

■ 特長 Features

**切りくず分断性能を
追求した座ぐりカッタ**
Counterboring cutter
with perfect chip control



**座ぐり加工は連続切削となるため、
切りくず分断性が最重要**

Since counterboring process is continuous cutting,
chip breaking capability is utmost important.

- 切れ刃に対して大きく盛り上がった
マッスルブレーカで抜群の切りくず分断性を
実現
- Excellent chip breaking capability with the enhanced
muscle breaker

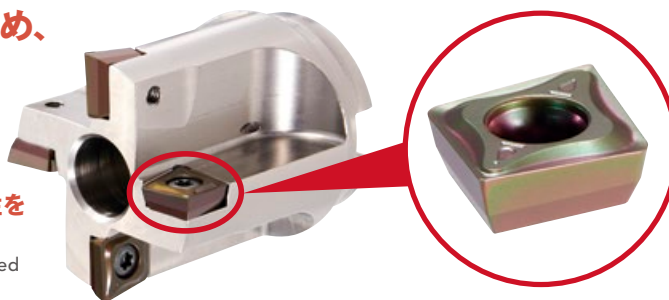

■ 豊富なラインナップ Broad size lineup

キャップボルトの座ぐり穴寸法規格に合わせたサイズラインナップ(ボルトねじサイズM8 ~ M52に対応)
Size lineup corresponding to the cap bolt's counterbore hole size (Corresponds to bolt screw sizes M8 to M52)

■ 六角穴付きボルトに対する座ぐり及びボルト穴の寸法

Dimensions of counterbore and bolt hole with hexagon socket head bolt

DC がカッタ径となります
D' represents the cutter diameter

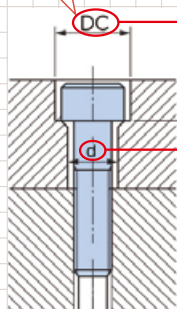

ねじの呼び Thread size	単位:mm Unit:mm									
	M8	M10	M12	M14	M16	M18	M20	M22	M24	
DC	14	17.5	20	23	26	29	32	35	39	
H	8.6	10.8	13	15.2	17.5	19.5	21.5	23.5	25.5	
d	9	11	14	16	18	20	22	24	26	

ねじの呼び Thread size	単位:mm Unit:mm								
	M27	M30	M33	M36	M39	M42	M45	M48	M52
DC	43	48	54	58	62	67	72	76	82
H	29	32	35	38	41	44	47	50	54
d	30	33	36	39	42	45	48	52	56



※正面フライス(横引き加工)
としては使用できません。
Cannot be used as a face milling
cutter

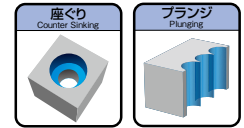

Specification

形状寸法表 Specification

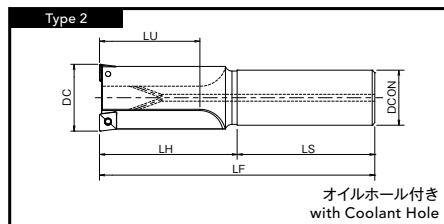
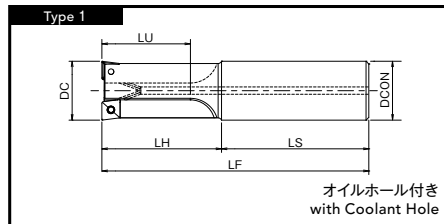

単位:mm Unit:mm

ツールNo. EDP No.	呼び Designation	外径 DC	刃数 ZEPF	全長 LF	首下長 LH	有効加工深さ LU	シャンク径 DCON	シャンク長 LS	最小下穴径 Min.Pre-Drilled Dia. 注1)	ae 注2) (max)	適用インサート Applicable Inserts	形状タイプ Type	標準価格 (Yen)
7832100	PZAG04R014SS20-2	14	2	100	30	21	20	70	6	4	①	1	28,600
7832101	PZAG06R0175SS20-2	17.5	2	105	35	26	20	70	5.5	6	②	1	28,600
7832102	PZAG06R020SS20-2	20	2	110	40	30	20	70	8	6		1	30,800
7832103	PZAG06R023SS25-2	23	2	125	50	34.5	25	75	11	6	③	1	30,800
7832104	PZAG09R026SS25-2	26	2	130	55	39	25	75	8	9		1	32,600
7832105	PZAG09R029SS32-2	29	2	140	60	43.5	32	80	11	9		1	32,600
7832106	PZAG09R032SS32-2	32	2	145	65	48	32	80	14	9		1	34,200
7832107	PZAG09R035SS32-2	35	2	150	70	52.5	32	80	17	9		2	35,400
7832108	PZAG09R039SS32-2	39	2	160	80	58.5	32	80	21	9		2	36,400
7832109	PZAG09R043SS32-2	43	2	170	90	64.5	32	80	25	9		2	40,100
7832110	PZAG09R048SS32-2	48	2	180	100	72	32	80	30	9		2	43,800

注1) 座ぐり加工を行う場合の下穴の最小値を示します。
These minimum pre-drilled hole sizes are required before counterboring operations.

※ 横引き不可です
Specialized for plunging.

注2) : ブランジ加工時の最大切込み(ae)
Maximum depth of cut in plunge milling

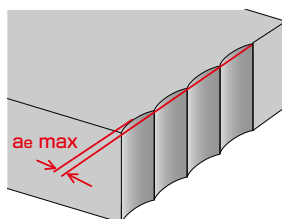

加工穴径に合わせた特殊品も承っております。詳細は当社営業へお問い合わせ下さい(φ14以上に対応)。
Special orders made according to the machined hole diameter are also accepted. Please contact OSG's sales division for details (for items over dia. 14).

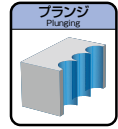

Specification

■形状寸法表 Specification

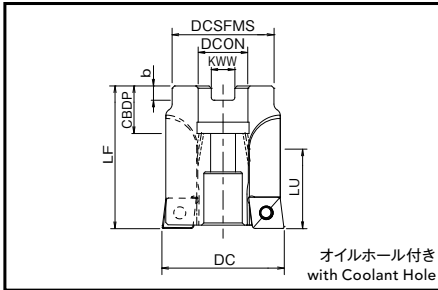

単位:mm Unit:mm

ツールNo. EDP No.	呼び Designation	外径 DC	刃数 ZEP	カッタ高さ LF	有効加工深さ LU	ボス径 DCSFMS	穴径 DCON	穴径深さ CBDP	端面キー溝		最小下穴径 Min. Pre-Drilled Dia. 注1)	ae 注2) (max)	適用インサート Applicable Inserts	標準価格 (Yen)
									幅 KWW	深さ b				
7832111	PZAG13R054M22-4	54	4	63	35	45	22	21	10.4	6.3	29	12.5	④	57,000
7832112	PZAG13R058M22-4	58	4	63	38	45	22	21	10.4	6.3	33	12.5		57,000
7832113	PZAG13R062M22-4	62	4	63	41	45	22	21	10.4	6.3	37	12.5		59,100
7832114	PZAG13R067M22-4	67	4	63	44	45	22	21	10.4	6.3	42	12.5		59,100
7832115	PZAG13R072M22-4	72	4	63	47	45	22	21	10.4	6.3	47	12.5		63,900
7832116	PZAG17R076M22-4	76	4	63	50	45	22	21	10.4	6.3	44	16	⑤	63,900
7832117	PZAG17R082M22-4	82	4	63	54	45	22	21	10.4	6.3	50	16		68,400

注1) 座ぐり加工を行う場合の下穴の最小値を示します。
These minimum pre-drilled hole sizes are required before counterboring operations.

※ 横引き不可です
Specialized for plunging.

注2) : ブランチ加工時の最大切込み(ae)
Maximum depth of cut in plunge milling

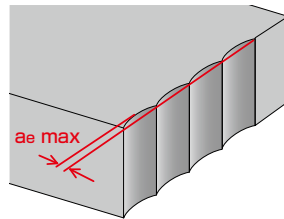

加工穴径に合わせた特殊品も承っております。詳細は当社営業へお問い合わせ下さい(φ14以上に対応)。

Special orders made according to the machined hole diameter are also accepted. Please contact OSG's sales division for details (for items over dia. 14).

Inserts

■形状寸法表 Specification

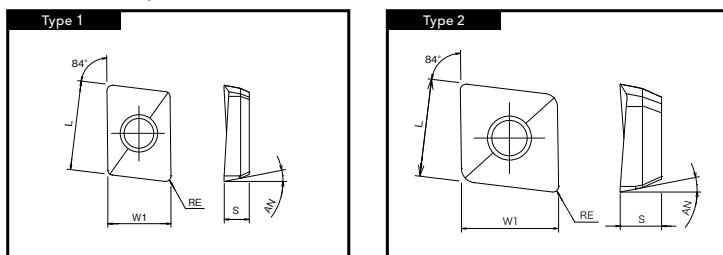

■適用インサート Applicable Inserts

単位:mm Unit:mm

呼び Designation	切れ刃数 No. of Cutting Edges	インサート寸法 Insert Size				形状 Type	適用ボディ Applicable Body	コーティング材種 Carbide Coated Materials		標準価格 (Yen)
		L×W1	厚さ S	逃げ角 AN	RE			XP8030	XC8035	
① ZPNT040104ER	2	6.35 × 4.45	1.76	11°	0.4	1	φ14	7814101	7815101	1,850
② ZPNT060204EN	2	6.95 × 6.95	2.93	11°	0.4	2	φ17.5~23	7814103	7815103	1,900
③ ZPNT090404EN	2	9.94 × 9.94	4.65	11°	0.4	2	φ26~48	7814106	7815106	1,930
④ ZPNT130504EN	2	13.92 × 13.92	5.46	11°	0.4	2	φ54~72	7814109	7815109	2,350
ZPNT130508EN	2				0.8			7814110	7815110	2,350
⑤ ZPNT170608EN	2	17.85 × 17.85	6.31	11°	0.8	2	φ76, 82	7814111	7815111	2,470

Accessories

■部品 Accessories

	ツールNo. EDP No.	呼び Designation	適用インサート Applicable Inserts	適用ボディ Applicable Body	推奨締め付けトルク Recommended Tightening Torque
 クランプねじ Clamping Screw	7808096	FS18536P (Torx 6IP)	① ZPNT04...	PZAG SS φ14	0.7 N·m
	7808138	FS22550P (Torx 7IP)	② ZPNT06...	PZAG SS φ17.5~23	1.0 N·m
	7808135	FS30570P (Torx 9IP)	③ ZPNT09...	PZAG SS φ26~48	2.2 N·m
	7808114	FS45510P (Torx 20IP)	④ ZPNT13...	PZAG BORE φ54~82	5.0 N·m
			⑤ ZPNT17...		

	ツールNo. EDP No.	呼び Designation	適用インサート Applicable Inserts	適用ボディ Applicable Body	標準価格 (Yen)
 レンチ Wrench	7808223	6IP-D (Torx 6IP)	① ZPNT04...	PZAG SS φ14	1,600
	7808224	7IP-D (Torx 7IP)	② ZPNT06...	PZAG SS φ17.5~23	1,370
	7808226	9IP-D (Torx 9IP)	③ ZPNT09...	PZAG SS φ26~48	1,600
	7808229	20IP-D (Torx 20IP)	④ ZPNT13...	PZAG BORE φ54~82	1,930
			⑤ ZPNT17...		

レンチは別途ご購入下さい。 The wrenches are sold separately from the cutters.

Cutting
Conditions

■被削材別推奨材質

Recommended Materials by Insert Type

◎第一推奨材質 Best
○第二推奨材質 Good

インサート材種 Insert Grades	切削油剤 Coolant	P	M	K	N	S	H
XP8030	有 Wet	◎	◎	○	○	○	○
XC8035	無 Dry	○		◎			
	有 Wet		○				

■切削条件基準表 Cutting Conditions 座ぐり加工・ブランチ加工共通 For both counterboring and plunge milling

被削材 Work Material	引張強さ・硬さ Tensile Strength・Hardness	切削速度 Vc (m/min) Cutting Speed	送り量 f(mm/rev) Feed Rate				
			φ14~φ17.5	φ20~φ23	φ26~φ48	φ54~φ72	φ76~φ82
P 軟鋼、低炭素鋼 Mild Steel, Carbon Steel (SS400, S10C) 炭素鋼、合金鋼 Carbon Steel, Alloy Steel (S50C, SCM440) ダイス鋼 Die Steel (SKD11, SKD61)	~180HB	160(100~200)	0.14(0.08~0.2)	0.18(0.1~0.25)	0.2(0.12~0.3)	0.4(0.2~0.6)	0.4(0.2~0.6)
	~280HB	150(100~200)	0.14(0.08~0.2)	0.18(0.1~0.25)	0.2(0.12~0.3)	0.4(0.2~0.6)	0.4(0.2~0.6)
	~280HB	120(80~180)	0.12(0.08~0.15)	0.14(0.1~0.2)	0.18(0.12~0.25)	0.4(0.2~0.5)	0.4(0.2~0.5)
M ステンレス鋼 Stainless Steel (SUS304, SUS420)	~250HB	130(80~180)	0.1(0.08~0.15)	0.12(0.1~0.2)	0.16(0.12~0.25)	0.35(0.2~0.5)	0.35(0.2~0.5)
K 鋳鉄 Cast Iron (FC250) ダクタイル鋳鉄 Ductile Cast Iron (FCD400)	~350N/mm ²	200(150~280)	0.16(0.08~0.25)	0.2(0.1~0.3)	0.3(0.15~0.4)	0.6(0.3~0.8)	0.6(0.3~0.8)
	~800N/mm ²	160(100~220)	0.14(0.08~0.2)	0.18(0.1~0.25)	0.2(0.15~0.3)	0.4(0.3~0.6)	0.4(0.3~0.6)
N アルミニウム合金 Aluminum Alloy	~13%Si	200(100~800)	0.16(0.08~0.25)	0.2(0.1~0.3)	0.3(0.15~0.4)	0.6(0.3~0.8)	0.6(0.3~0.8)
S 超耐熱合金(湿式) Superalloy (Wet) (Inconel718) チタン合金(湿式) Titanium Alloy (Wet) (Ti-6Al-4V)	-	50(30~60)	0.08(0.05~0.14)	0.08(0.06~0.14)	0.12(0.08~0.2)	0.25(0.16~0.4)	0.25(0.16~0.4)
	-	60(30~100)	0.08(0.05~0.14)	0.1(0.06~0.16)	0.14(0.08~0.2)	0.3(0.16~0.5)	0.3(0.16~0.5)
H プリハードン鋼 Pre-hardened Steel (NAK80) 調質鋼 Hardened Steel (SKD11)	40~43HRC	100(60~120)	0.08(0.05~0.14)	0.1(0.06~0.16)	0.14(0.08~0.2)	0.3(0.16~0.5)	0.3(0.16~0.5)
	50~55HRC	60(40~80)	0.08(0.05~0.14)	0.08(0.05~0.14)	0.12(0.08~0.2)	0.25(0.16~0.4)	0.25(0.16~0.4)

- この切削条件基準表は、実切削速度における一般的な値を示したものです。加工環境に合わせて適宜調整して下さい。
- インサートの装着に際しては、傷や汚れを取り除いた状態でしっかりと取り付けて下さい。
- 被削材の保持はしっかりと行い、変形、たわみ、振動が起こらない状態にして下さい。

- The above cutting conditions are to be used as general guidelines. Adjustments may be necessary depending on actual cutting condition.
- Inserts should be attached to the holder tightly in a very neat condition.
- Fasten the work material to reduce the possibility of work deformation, deflection of machined surface, or vibration.

Cutting Data

加工データ Cutting Data

S50Cの座ぐり加工 Counterboring in S50C

使用工具 Tool	PZAG09R026SS25-2 (φ26×2刃)
使用インサート(材種) Insert (grade)	ZPNT090404EN (XC8035)
被削材 Work Material	S50C
切削速度 Cutting Speed	150m/min (1,837min ⁻¹)
送り速度 Feed	550mm/min (0.3mm/rev)
座ぐり深さ Counterbore Depth	17.5mm
切削油剤 Coolant	ドライ Dry
使用機械 Machine	立形マシニングセンタ(BT50) Vertical Machining Center

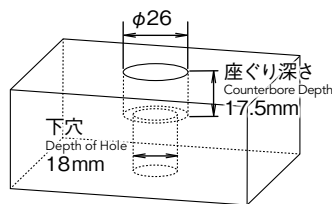

M16キャップボルト用の座ぐり加工において、分断された切りくずが排出され安定した連続加工が行えた。

In the counterboring of a M16 cap bolt, excellent chip breaking was performed, enabling consecutive processing.

SS400大型部品の座ぐり加工 Counterboring of large parts in SS400

使用工具 Tool	PZAG17R076M22-4 (φ76×4刃)	他社ハイスエンドミル (φ30×4刃) Competitor's HSS Endmill
使用インサート(材種) Insert (grade)	ZPNT170608EN (XP8030)	
被削材 Work Material	SS400	
切削速度 Cutting Speed	112m/min (470min ⁻¹)	30m/min (318min ⁻¹)
送り速度 Feed	140mm/min (0.3mm/rev) 0.5mmステップ Step	127mm/min (0.1mm/t)
座ぐり深さ Counterbore Depth	51mm	ap=51mm ae=3mm×4パス Pass
切削油剤 Coolant	水溶性切削油剤 Water-Soluble	
使用機械 Machine	門形マシニングセンタ(BT50) Double Column Machining Center	

	加工時間(分/穴) Cutting Time (min./hole)					
	0.5	1	1.5	2	2.5	3
PZAG						
他社品 Competitor						

SS400の大型部品のボルト穴座ぐり加工において、ハイスエンドミルにて繰り広げ加工を行っていた。1穴の加工時間が従来の加工では3分程度かかっていたが、PZAGの加工では1分30秒と半分に短縮出来た。

A HSS end mill was used in the counterboring of a bolt for a large part in SS400. The PZAG was able to reduce machining time by half from 3 minutes per hole to 1.5 minutes.

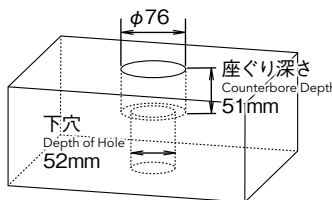

» Phoenix PLDS

インデキサブルリーディングドリル
Centering and Chamfering Cutter

Phoenix Centering and Chamfering Cutter



■ 1本でセンタリング(もみつけ)、面取り、V溝加工が可能

Centering, countersinking and V slotting can be performed with a single tool

センタリング(もみつけ)加工

Centering

V溝加工

V slotting

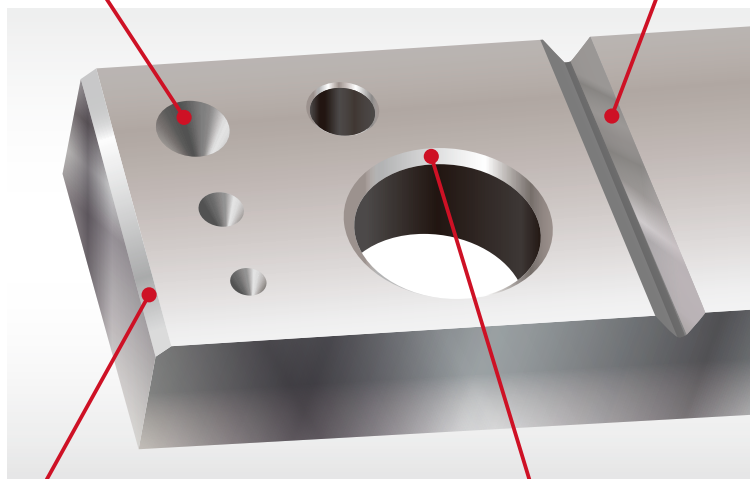

コーナ面取り

Corner chamfering

口元面取り

Hole entry countersinking



■ 耐チップング性と切れ味を両立した経済的な3コーナ仕様インサート

Economical 3-corner insert with both chipping resistance and sharpness

被削材に合わせて選べる強靱なインサート材種

High-strength insert grades that can be selected according to the work material

鋼・鋳鉄用 ————— XP9020

For steel and cast iron

ステンレス鋼・耐熱合金用 ————— XP2040

For stainless steel and heat resistant alloys

過酷なセンタリング加工を可能にする

高剛性な先端ネガチャンファ

Highly rigid negative chamfer tip that enables difficult centering operations

最適な切りくず形状を実現する刃先仕様

Cutting edge specification that enables the creation of optimum chip shape

大きなすくい角で低抵抗

Large rake angle and low resistance

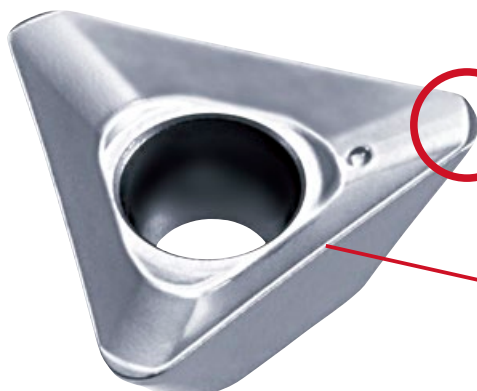

■工具の長寿命化と良好な加工面を実現するボディ設計

Optimal body design that enables long tool life and excellent machining surface

切りくず排出性と刃先への冷却効果を向上させるオイルホール付きボディ

The cutter body is equipped with a coolant hole to improve chip evacuation and cooling effect on the cutting edge



被削面のバリを抑え込むネガティブなアキシャルレーキ角

Negative axial rake angle that suppresses burrs on the work surface



■加工のポイント Machining Tips

穴面取りはドリル加工の後に!

Countersinking takes place after drilling!

センタリング加工時、センタリング径はドリル径より小さくして下さい

For centering, make the centering diameter smaller than the drill diameter

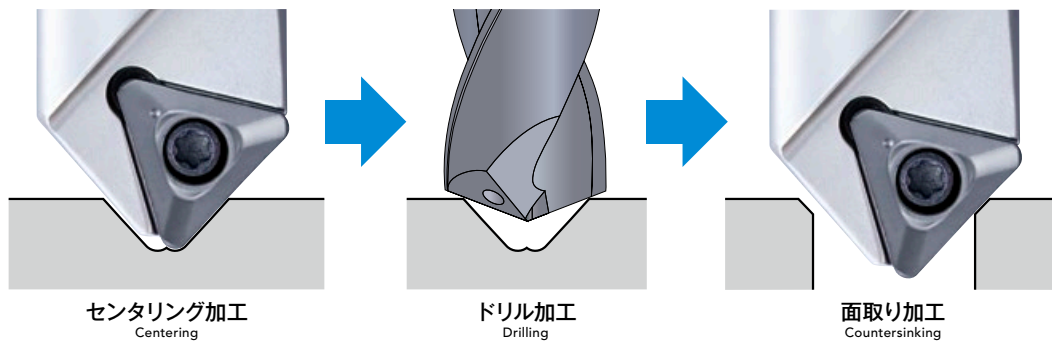

✕ ドリル径に対して不適切なセンタリング径

Inappropriate centering diameter relative to the drill diameter

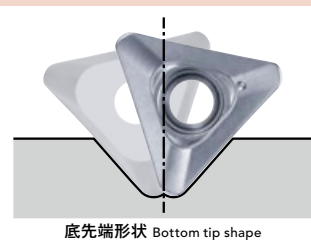

底先端形状 Bottom tip shape

インサートの形状により穴底部にセンタ残りが生じます。そのセンタ残りがドリル加工に悪影響を及ぼすことがあります。
Center remnants may occur at the bottom of the hole due to the shape of the insert, which may adversely affect the drilling process.

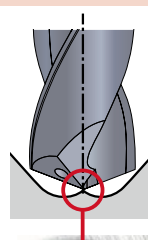

センタ残り Center remnants

✕ 穴面取りを兼ねたセンタリング加工

Centering that also serves as countersinking

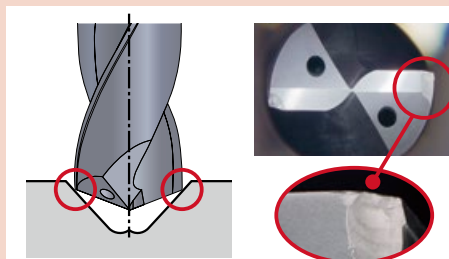

センタリング径がドリル径より大きいとドリルの肩からワークにあたるので刃欠けの原因になります。

When the centering diameter becomes larger than the drill diameter, the shoulder of the drill will collide with the workpiece, which may cause chipping on the cutting edge.

Phoenix

インデキサブルリーディングドリル ストレートシャンクタイプ

Centering and Chamfering Cutter Straight Shank Type

PLDS SS

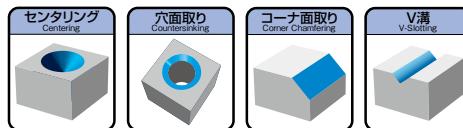

Specification

■形状寸法表 Specification

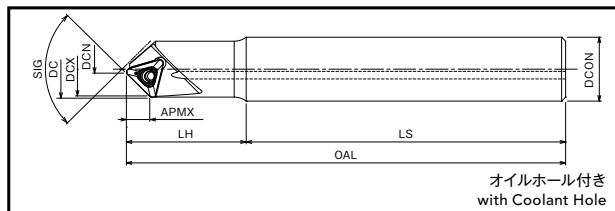

単位:mm Unit:mm

ツールNo. EDP No.	呼び Designation	先端角 SIG	加工径		外径 DC	刃数 ZEFP	シャンク径 DCON	シャンク長 LS	全長 OAL	首下長 LH	APMX	重量 (kg)	標準価格 (Yen)
			最小 DCN	最大 DCX									
7803401	PLDS11R002SS16-90	90°	2.5	13.5	14.4	1	16	80	110	30	5.8	0.15	12,200
7803402	PLDS11R002SS16-L90							170	200		5.8	0.28	15,500
7803403	PLDS11R002SS16-120	120°	2.4	16	17.3	1	16	80	110	30	4	0.15	12,200
7803404	PLDS11R002SS16-L120							170	200		4	0.28	15,500

Phoenix

インデキサブルリーディングドリル ねじ込みタイプ
Centering and Chamfering Cutter Screw Fit Type

PLDS SF

Specification

■形状寸法表 Specification

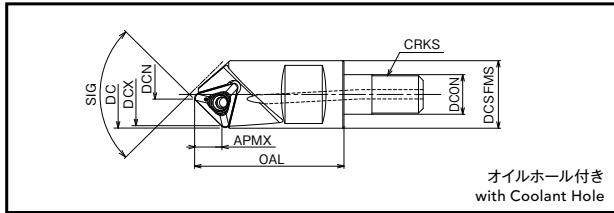

PLDS ねじ込みタイプ Screw Fit Type

単位:mm Unit:mm

ツールNo. EDP No.	呼び Designation	先端角 SIG	加工径 Insert Size		外径 DC	刃数 ZEP	取付け径 DCON	ねじサイズ CRKS	スバナサイズ Spanner Size	全長 OAL	端面径 DCSFMS	APMX	重量 (kg)	適用シャンク ホルダタイプ Applicable Shank	標準価格 (Yen)
			最小 DCN	最大 DCX											
7803405	PLDS11R002SF8-90	90°	2.5	13.5	14.4	1	8.5	M8	10	32	14.5	5.8	0.05	③	12,700
7803406	PLDS11R002SF8-120	120°	2.4	16	17.3							4	0.05		12,700

シャンクホルダについてはp.242 ~ p.244をご覧ください。
See p.242-p.244 for shank holders.

Inserts

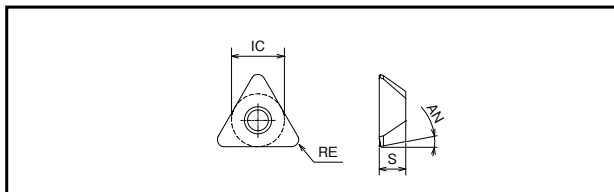

■適用インサート Inserts

単位:mm Unit:mm

呼び Designation	切れ刃数 No. of Cutting Edges	インサート寸法 Insert Size				コーティング材種 Grade of Coated Materials		標準価格 (Yen)
		内接円径 IC	厚さ S	逃げ角 AN	RE	XP9020	XP2040	
TPKT110308ER-DM	3	6.35	3.18	11°	0.8	7814205	7813205	1,440

Accessories

■部品 Accessories

	ツールNo. EDP No.	呼び Designation	推奨締め付けトルク Recommended Tightening Torque
クランプねじ Clamping Screw	7808138	F522550P (Torx 7IP)	1.0 N・m

	ツールNo. EDP No.	呼び Designation	標準価格 (Yen)
レンチ Wrench	7808224	7IP-D (Torx 7IP)	1,370

レンチは別途ご購入下さい。 The wrenches are sold separately from the cutters.

Cutting Conditions

■被削材別推奨材質

Recommended Materials by Insert Type

◎第一推奨材質 Best

○第二推奨材質 Good

インサート材種 Insert Grades	ブレーカ Insert Breaker	切削油剤 Coolant	P	M	K	N	S	H
XP9020	DM	有 Wet	◎	○	◎	○	○	○
XP2040	DM	無 Dry	○	○				
		有 Wet	○	◎		○	◎	◎

■切削条件基準表 Cutting Conditions

被削材 Work Material	引張強さ・硬さ Tensile Strength・Hardness	切削速度 Vc (m/min) Cutting Speed	回転速度 (min ⁻¹) Speed	送り量 (mm/rev) Feed Rate	
				センタリング加工 Centering	面取り加工(横送り) Countersinking (Side Feed)
P 軟鋼、低炭素鋼 Mild Steel, Carbon Steel (S5400, S10C) 炭素鋼、合金鋼 Carbon Steel, Alloy Steel (S50C, SCM440) ダイス鋼 Die Steel (SKD11, SKD61)	~180HB	80 (60 ~ 120)	1,500 ~ 3,000	0.06 (0.03 ~ 0.08)	0.08 (0.05 ~ 0.12)
	~280HB	80 (60 ~ 120)	1,500 ~ 3,000	0.06 (0.03 ~ 0.08)	0.08 (0.05 ~ 0.12)
	~280HB	80 (60 ~ 120)	1,500 ~ 3,000	0.06 (0.03 ~ 0.08)	0.08 (0.05 ~ 0.12)
M ステンレス鋼 Stainless Steel (SUS304, SUS420)	~250HB	80 (60 ~ 100)	1,500 ~ 2,500	0.06 (0.03 ~ 0.08)	0.08 (0.05 ~ 0.12)
K 鋳鉄 Cast Iron (FC250) ダクタイル鋳鉄 Ductile Cast Iron (FCD400)	~350N/mm ²	100 (60 ~ 140)	1,500 ~ 3,500	0.06 (0.03 ~ 0.08)	0.08 (0.05 ~ 0.12)
	~800N/mm ²	100 (60 ~ 140)	1,500 ~ 3,500	0.06 (0.03 ~ 0.08)	0.08 (0.05 ~ 0.12)
N アルミニウム合金 Aluminum Alloy	~13%Si	150 (100 ~ 200)	2,500 ~ 5,000	0.06 (0.03 ~ 0.08)	0.08 (0.05 ~ 0.12)
S 耐熱合金(湿式) Superalloy (Wet) (Inconel 718) チタン合金(湿式) Titanium Alloy (Wet) (Ti-6Al-4V)	-	35 (25 ~ 60)	600 ~ 1,500	0.04 (0.03 ~ 0.06)	0.08 (0.05 ~ 0.12)
	-	40 (30 ~ 100)	700 ~ 2,500	0.06 (0.03 ~ 0.08)	0.08 (0.05 ~ 0.12)
H プリハードン鋼 Pre-hardened Steel (NAK80) ダイカスト用鋼 Steel for Die Casting (DAC-MAGIC, DH31)	40~43HRC	80 (60 ~ 100)	1,500 ~ 3,000	0.06 (0.03 ~ 0.08)	0.08 (0.05 ~ 0.12)
	43~48HRC	60 (50 ~ 80)	1,200 ~ 2,000	0.06 (0.03 ~ 0.08)	0.08 (0.05 ~ 0.12)

- この切削条件基準表は、実切削速度における一般的な値を示したものです。加工環境に合わせて適宜調整して下さい。
- インサートの装着に際しては、傷や汚れを取り除いた状態でしっかりと取り付けて下さい。
- 被削材の保持はしっかりと行い、変形、たわみ、振動が起こらない状態にして下さい。
- V溝加工の送り量は、上表の面取り加工(横送り)の80%でご使用下さい。

- The above cutting conditions are to be used as general guidelines. Adjustments may be necessary depending on actual cutting condition.
- Inserts should be attached to the holder tightly in a very neat condition.
- Fasten the work material to reduce the possibility of work deformation, deflection of machined surface, or vibration.
- For the feed of V slotting, use 80% of the countersinking (side feed) shown in the above table.

■センタリング加工深さの目安(H) Standard centering depth (H)

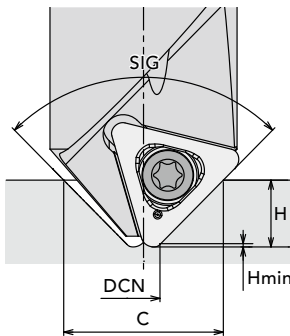

SIG=90°の場合 When SIG=90°

Hmin=0.25

DCN = φ2.5 (最小加工径)

(Minimum machined hole diameter)

$$H = \frac{C - DCN}{2} + H_{min}$$

$$= \frac{C}{2} - 1$$

H: センタリング加工深さ C: 皿穴径

例) SIG=90° C=φ10(皿穴径)の場合
Hの値は5mmではなく、4mmになります。

SIG=120°の場合 When SIG=120°

Hmin=0.1

DCN = φ2.4 (最小加工径)

(Minimum machined hole diameter)

$$H = \frac{C - DCN}{3.46} + H_{min}$$

$$= \frac{C}{3.46} - 0.594$$

H: Centering depth C: Countersink diameter

Example: When SIG=90° C=φ10 (Countersink diameter)
The value of H will be 4 mm instead of 5 mm.

Cutting Data

加工データ Cutting Data

SUS304 90° センタリング加工 90° centering

使用工具 Tool	PLDS11R002SS16-90
使用インサート(材種) Insert (grade)	TPKT110308ER-DM (XP2040)
被削材 Work Material	SUS304
切削速度 Cutting Speed	63m/min (2,000min ⁻¹)
送り速度 Feed	80mm/min (0.04mm/rev)
加工深さ Processing depth	4mm (皿穴径φ10) Countersink diameter
切削油剤 Coolant	水溶性切削油剤(内部給油) Water-Soluble (Internal)
使用機械 Machine	横形マシニングセンタ(HSK63) Horizontal Machining Center

	加工穴数 Number of Holes			
	100	200	300	400
PLDS	継続可能 Still Running			
他社品 A Competitor	欠け Chipping			
他社品 B Competitor	欠け Chipping			

PLDSは他社品の2倍以上の穴数を加工した後も継続使用が可能な
 摩耗状況であった。
 The PLDS exhibits good wear condition and can continue to be used even after
 machining more than twice the number of holes as the competitor products.



S50C 90° センタリング加工 90° Centering

使用工具 Tool	PLDS11R002SS16-90
使用インサート(材種) Insert (grade)	TPKT110308ER-DM (XP9020)
被削材 Work Material	S50C
切削速度 Cutting Speed	94m/min (3,000min ⁻¹)
送り速度 Feed	180mm/min (0.06mm/rev)
加工深さ Processing depth	4mm (皿穴径φ10) Countersink diameter
加工穴数 Number of Holes	700穴 Holes
切削油剤 Coolant	水溶性切削油剤(内部給油) Water-Soluble (Internal)
使用機械 Machine	横形マシニングセンタ(HSK63) Horizontal Machining Center

700穴加工時の摩耗状況 Wear comparison after machining 700 holes

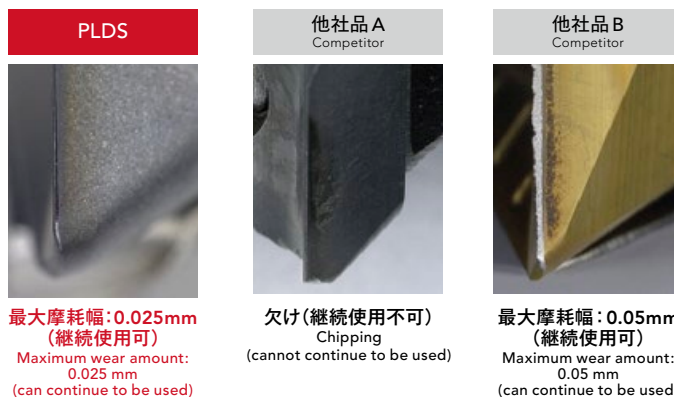

PLDSは700穴加工後も摩耗が少なく、継続使用可能な状態であった。
 The PLDS exhibits minimal wear even after machining 700 holes and is in a state
 where it can continue to be used.

Phoenix PAS

正面フライス スクエアタイプ
45° Face Milling Square Insert Type

Phoenix 45° Square



■ インサート形状 Insert form

ポジブレーカにより高剛性かつ切削抵抗軽減を実現

Positive breaker enables high rigidity and reduces cutting force resistance

- 裏表4コーナ(計8コーナ)仕様。最大切込み**6.5mm**。
4 cutting edges per side (a total of 8 corners) specifications, 6.5 mm maximum depth of cut.
- 荒から仕上げ加工まで広範囲に適応。
Applicable in a wide range of work stages, from rough milling to finishing.

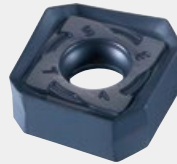

ポジ刃型による 切削抵抗軽減

The positive edge reduces cutting resistance

■ 高精度仕上げ面 High precision surface finishing

工具: PAS15R080M25.4-6 (SNKU1505AZER-GR XC1015)

使用機械: 立形マシニングセンタ (BT50) 被削材: FCD500

Machine: Vertical Machining Center Work Material: FCD500
切削条件: $V_c=250\text{m/min}$ ($n=995\text{min}^{-1}$) $V_f=597\text{mm/min}$ ($fz=0.1\text{mm/t}$) $a_p=0.2\text{mm}$ $a_e=50\text{mm}$ 乾式 Dry

底面粗さ Bottom roughness

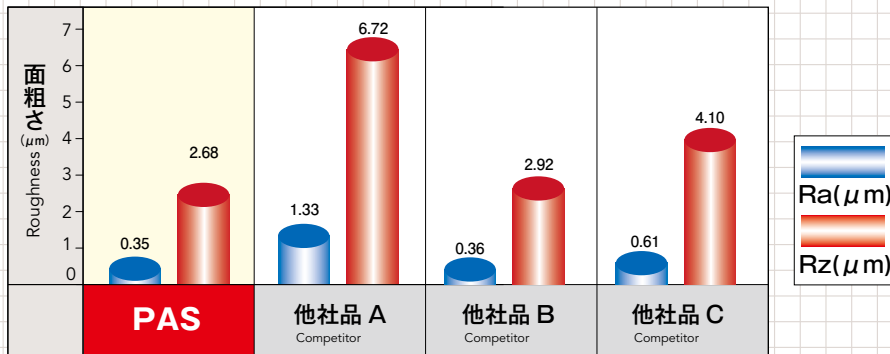

■ 低抵抗加工 Low resistance machining

工具: PAS15R080M25.4-6 (SNKU1505AZER-GR XC1015)

使用機械: 立形マシニングセンタ (BT50) 被削材: FCD500

Machine: Vertical Machining Center Work Material: FCD500
切削条件: $V_c=180\text{m/min}$ ($n=716\text{min}^{-1}$) $V_f=860\text{mm/min}$ ($fz=0.2\text{mm/t}$) $a_p=3\text{mm}$ $a_e=50\text{mm}$ 乾式 Dry

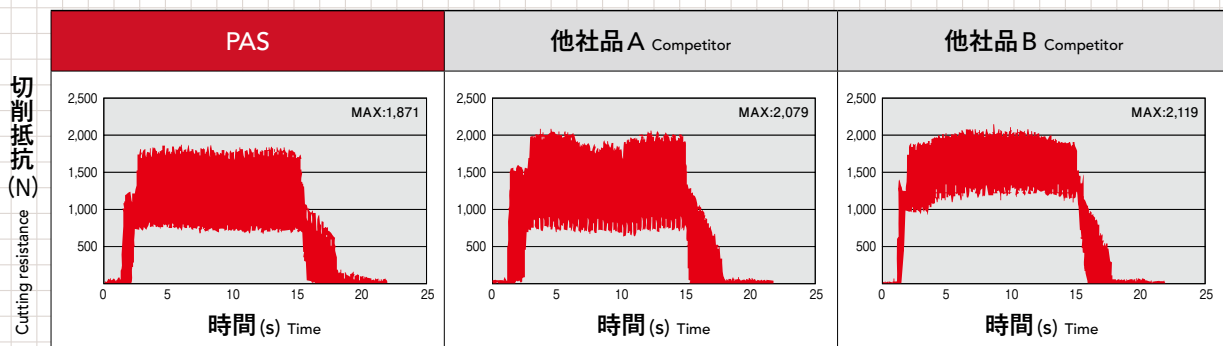

Phoenix

正面フライススクエアタイプ ボアタイプ
45° Face Milling Square Insert Type with Bore Type

PAS BORE

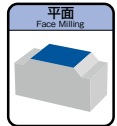
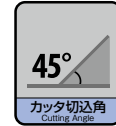

Specification

形状寸法表 Specification

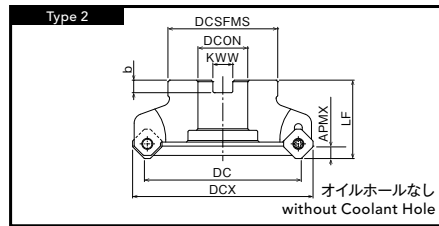
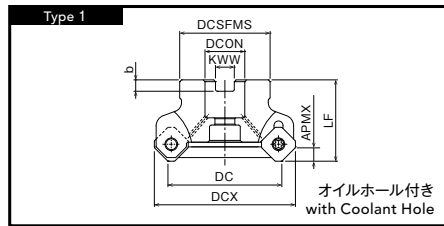

単位:mm Unit:mm

ツールNo. EDP No.	呼び Designation	外径 DC	カッタ 外径 DCX	刃数 ZEPF	カッタ 高さ LF	ボス径 DCSFMS	穴径 DCON	端面キー溝 Key Slot		APMX	重量 (kg)	形状タイプ Type	標準価格 (Yen)
								幅 kWW	深さ b				
7802000	PAS15R050M22-4	50	65	4	45	45	22	10.4	6.3	6.5	0.41	1	82,400
7802001	PAS15R063M22-5	63	78	5	45	50	22	10.4	6.3	6.5	0.59	1	96,900
7802002	PAS15R080M25.4-6	80	95	6	50	60	25.4	9.5	6	6.5	1.06	1	118,000
7802003	PAS15R100M31.7-7	100	115	7	50	70	31.75	12.7	8	6.5	1.52	2	140,000
7802004	PAS15R125M38.1-8	125	140	8	63	90	38.1	15.9	10	6.5	3.25	2	172,000

Inserts

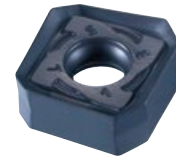
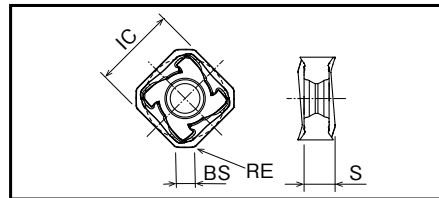

適用インサート Inserts

単位:mm Unit:mm

呼び Designation	切れ刃数 No. of Cutting Edges	インサート寸法 Insert Size				コーティング材種 Grade of Coated Materials				標準価格 (Yen)
		IC	厚さ S	RE	さらい刃 (副切れ刃) BS	XC3025	XP3035	XP2040	XC1015	
SNKU1505AZER-GM	8	15.88	7.18	1.0	3.65	7819061	7814061	7813061		2,430
SNKU1505AZER-GR	8	15.88	7.18	1.0	3.65				7812060	2,430

Accessories

部品 Accessories

	ツールNo. EDP No.	呼び Designation	適用ボディ Applicable Body
 クランプねじ Clamping Screw	7808131	FS45513P (Torx 20IP)	PAS BORE φ50~125

	ツールNo. EDP No.	呼び Designation	適用ボディ Applicable Body	標準価格 (Yen)
 T型レンチ T-Handle Wrench	7808000	20IP-T (Torx 20IP)	PAS BORE φ50~125	2,520

レンチは別途ご購入下さい。 The wrenches are sold separately from the cutters.

Phoenix

正面フライス スクエアタイプ

45° Face Milling Square Insert Type

PAS

■被削材別推奨材質

Recommended Materials by Insert Type

◎第一推奨材質 Best

○第二推奨材質 Good

インサート材種 Insert Grades	ブレーカ Insert Breaker	切削油剤 Coolant	P	M	K	N	S	H
XC3025	GM	無 Dry	◎		○			
XP3035	GM	無 Dry	◎	○	○			
		有 Wet						
XP2040	GM	無 Dry	○	○				○
		有 Wet	○	◎			○	
XC1015	GR	無 Dry			◎			

GM: 中切削用 GR: 重切削用
GM: Middle Cutting GR: Heavy Cutting

Cutting Conditions

■切削条件基準表 Cutting Conditions

	被削材 Work Material	引張強さ・硬さ Tensile Strength・Hardness	切削速度 VC(m/min) Cutting Speed	一刃当たりの送り量 fz (mm/t) Feed per Tooth	切込深さ ap (mm) Depth of Cut
P	軟鋼、低炭素鋼 Mild Steel, Carbon Steel (SS400, S10C)	~180HB	180 (100 ~ 250)	0.18 (0.15 ~ 0.35)	3
	炭素鋼、合金鋼 Carbon Steel, Alloy Steel (S50C, SCM440)	~280HB	180 (100 ~ 250)	0.18 (0.15 ~ 0.35)	3
	ダイス鋼 Die Steel (SKD11, SKD61)	~280HB	150 (80 ~ 200)	0.15 (0.1 ~ 0.3)	3
M	ステンレス鋼(湿式) Stainless Steel (Wet) (SUS304, SUS420)	~250HB	120 (80 ~ 180)	0.12 (0.08 ~ 0.25)	3
K	鑄鉄 Cast Iron (FC250)	~300N/mm ²	180 (100 ~ 350)	0.2 (0.15 ~ 0.35)	4
	ダクタイル鑄鉄 Ductile Cast Iron (FCD400)	~600N/mm ²	180 (100 ~ 270)	0.2 (0.1 ~ 0.3)	3
H	プリハードン鋼 Pre-hardened Steel (NAK80)	40~43HRC	100 (60 ~ 150)	0.12 (0.08 ~ 0.2)	1.5
	ダイカスト用鋼 Steel for Die Casting (DAC-MAGIC, DH31)	43~48HRC	80 (40 ~ 120)	0.1 (0.05 ~ 0.15)	0.5
	調質鋼 Hardened Steel (SKD11)	50~60HRC	60 (40 ~ 90)	0.08 (0.05 ~ 0.15)	0.5

・上記の数値は実切削速度における一般的な値を示したものです。加工環境に合わせて適宜調整して下さい。
The above cutting conditions are to be used as general guidelines. Adjustments may be necessary depending on actual cutting condition.

Cutting Data

加工データ Cutting Data

プレス金型基準面 荒取り加工 Die mold surface, rough milling

使用工具 Tool	PAS15R100M31.7-7 (φ100×7刃)	他社品 φ63 Competitor
使用インサート(材種) Insert (grade)	SNKU1505AZER-GR (XC1015)	超硬コーティングインサート Coated Carbide Insert
被削材 Work Material	FCD500	
切削速度 Cutting Speed	200m/min (637min ⁻¹)	120m/min (600min ⁻¹)
送り速度 Feed	1,500mm/min (0.37mm/t)	2,700mm/min (0.9mm/t)
切込深さ Depth of Cut	3mm	1mm
切削幅 Width of Cut	MAX 60mm	MAX 40mm
切削油剤 Coolant	なし(エアブロー) Air Blow	
使用機械 Machine	門形マシニングセンタ(BT50) Double Column Machining Center	

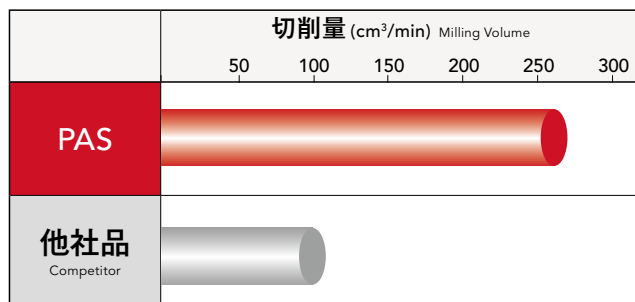

従来は他社高送りカッタを使用していたが切込みを入れられないため取り代ムラの多いワークに対してエアカットが多くなってしまっていた。しかしPASでは切込みを大きく入れることができるためエアカット削減が可能で、さらに切削量も約2.5倍にUPし加工時間も約60%ダウンすることができた。

In the past, due to the limited depth of cut, competitor's high feed cutters often leave a large amount of work material uncut, creating a need for aircut. This challenge has been overcome with the introduction of the PAS, which is capable of milling difficult-to-reach areas, thus eliminating 2.5 times more work materials than competitor's high feed cutters and decreasing machining time by 60%.

部品の荒取り加工 Rough milling of parts

使用工具 Tool	PAS15R080M25.4-6 (φ80×6刃)	他社品 A、B Competitor
使用インサート(材種) Insert (grade)	SNKU1505AZER-GM (XP3035)	超硬コーティングインサート Coated Carbide Insert
被削材 Work Material	S50C	
切削速度 Cutting Speed	200m/min (796min ⁻¹)	
送り速度 Feed	955mm/min (0.2mm/t)	
切込深さ Depth of Cut	ap=2mm ae=50mm	
切削油剤 Coolant	なし(エアブロー) Air Blow	
使用機械 Machine	立形マシニングセンタ(BT50) Vertical Machining Center	

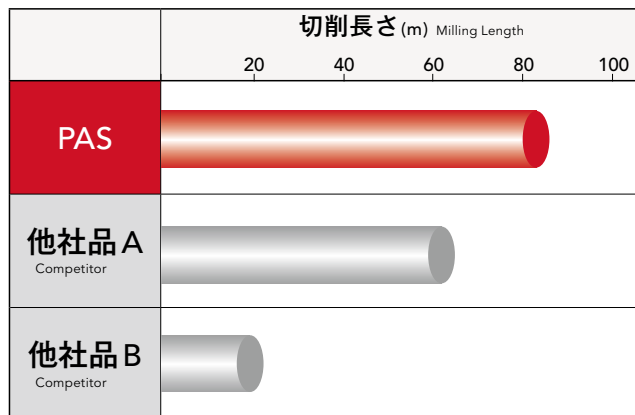

部品の荒取り加工において各社比較を行った結果、他社品は早期摩耗大・チッピングが発生したがPASは正常摩耗で耐久1.4倍以上となった。

Competitors' products and the PAS were compared in the rough milling stage under identical conditions. The competitors' tools had large chippings and were worn out at early stages. The PAS, in contrast, showed normal cutting wear and attained more than 1.4 times the durability.

» Phoenix PAO

正面フライス オクタゴンタイプ
45° Face Milling Octagon Insert Type

Phoenix 45° Octagon



■ インサート形状 Insert form

ネガ刃形とポジ逃げ角により高剛性かつシャープな切れ味を兼ね備えた形状

Achieves high rigidity and ultra sharp cutting edge with the negative cutter form and positive relief angle

- 経済的な裏表8コーナ(計16コーナ)仕様。最大切込み**3.5mm**
An economical 8 corners per side (16 corners in total) specification, 3.5 mm maximum depth of cut.

- さらい刃形状により面粗さ向上
さらい刃=2mm

The new cutting edge geometry of the secondary blade further improves surface roughness.
Secondary cutting blade : 2mm.

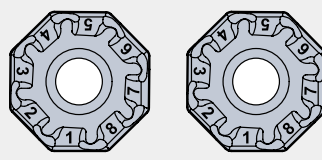
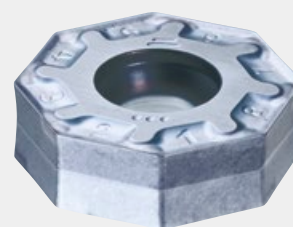
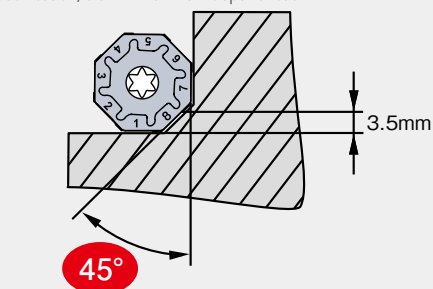
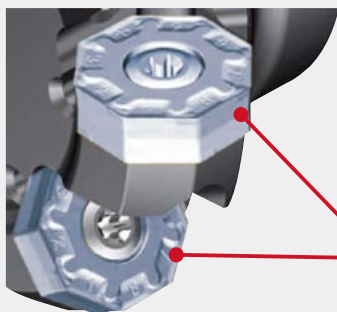

- 各インサートの数字を合わせてセッティングすることによりバラつきを抑えることが可能。
Each insert edge is individually numbered. By matching the numbers during setup, runout can be minimized.

■ 高精度仕上げ面(ワイパーインサート)

High precision surface finishing (Wiper Insert)

工具 : PAO06R160M50.8W-20 (OZKU060508SR-GM XC1015)

ワイパーインサート : XAHT060525SR-GM XP3035

使用機械 : 立形マシニングセンタ(BT50)

被削材 : FCD500

切削条件 : $V_c=250\text{m/min}$ ($n=500\text{min}^{-1}$) $V_f=1,500\text{mm/min}$ ($f_z=0.15\text{mm/t}$) $a_p=0.2\text{mm}$ $a_e=120\text{mm}$ 乾式 Dry

底面粗さ Bottom roughness

$R_a=0.43\mu\text{m}$
 $R_z=2.63\mu\text{m}$

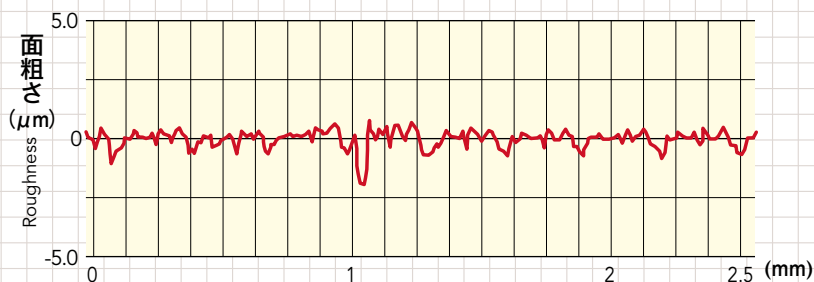

Phoenix

正面フライス オクタゴンタイプ ポアタイプ

45° Face Milling Octagon Insert Type with Bore Type

PAO BORE

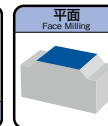

Specification

形状寸法表 Specification

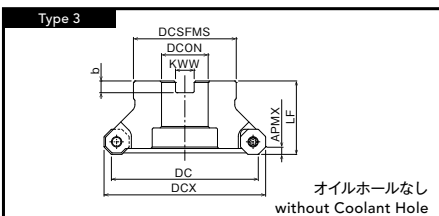
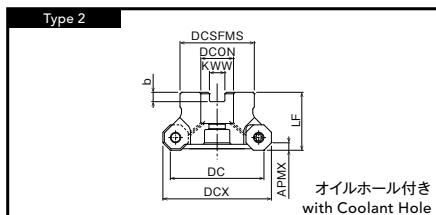
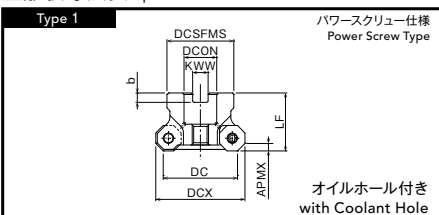

ねじ止めタイプ Screw type

単位:mm Unit:mm

ツールNo. EDP No.	呼び Designation	外径 DC	カッタ 外径 DCX	刃数 ZEFP	カッタ 高さ LF	ボス径 DCSFMS	穴径 DCON	端面キー溝 Key Slot		APMX	重量 (kg)	形状タイプ Type	標準価格 (Yen)
								幅 kWW	深さ b				
7802020	PAO06R050M22-5	50	60.2	5	40	45	22	10.4	6.3	3.5	0.35	1	85,600
7802021	PAO06R063M22-7	63	73.2	7	40	50	22	10.4	6.3	3.5	0.51	2	105,000
7802022	PAO06R080M25.4-8	80	90.2	8	50	60	25.4	9.5	6	3.5	1.05	2	121,000
7802023	PAO06R100M31.7-10	100	110.2	10	50	70	31.75	12.7	8	3.5	1.51	3	143,000
7802024	PAO06R125M38.1-12	125	135.2	12	63	90	38.1	15.9	10	3.5	2.98	3	166,000

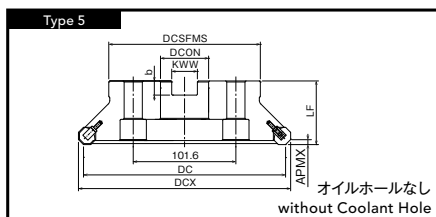
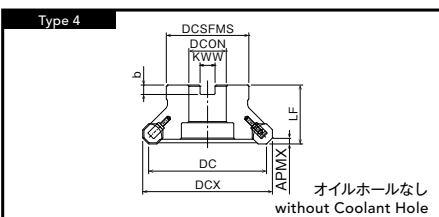

ウェッジ止めタイプ Wedge type

単位:mm Unit:mm

ツールNo. EDP No.	呼び Designation	外径 DC	カッタ 外径 DCX	刃数 ZEFP	カッタ 高さ LF	ボス径 DCSFMS	穴径 DCON	端面キー溝 Key Slot		APMX	重量 (kg)	形状タイプ Type	標準価格 (Yen)
								幅 kWW	深さ b				
7802089	PAO06R100M31.7W-14	100	110.2	14	50	70	31.75	12.7	8	3.5	1.37	4	231,000
7802091	PAO06R125M38.1W-17	125	135.2	17	63	90	38.1	15.9	10	3.5	2.81	4	267,000
7802093	PAO06R160M50.8W-20	160	170.2	20	63	100	50.8	19	11	3.5	4.5	4	316,000
7802095	PAO06R200M47.6W-25	200	210.2	25	63	150	47.625	25.4	14	3.5	7.75	5	395,000

在庫区分は全てC(標準在庫品)となります。 Stock are categorized as C (Standard stock item).

Phoenix

正面フライス オクタゴンタイプ

45° Face Milling Octagon Insert Type

PAOインサート

Inserts

Inserts

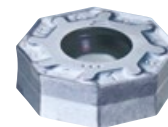
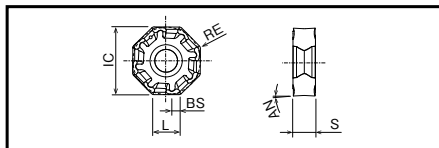

■適用インサート Inserts

単位:mm Unit:mm

呼び Designation	切れ刃数 No. of Cutting Edges	インサート寸法 Insert Size						コーティング材種 Grade of Coated Materials							標準価格 (Yen)		
		内接円径 IC	厚さ S	L	逃げ角 AN	RE	ざらい刃 (副切れ刃) BS	XC3020	XP3025	XC3030	XP3035	XP2025	XP2040	XC1015		XP1020	XC5040
OZKU060508SR-GL	16	17.1	5.66	6	3°	0.8	2	7827063	7828063	7825063	7814063	7826063	7813063				2,380
OZKU060508SR-GM	16	17.1	5.66	6	3°	0.8	2	7827062	7828062	7825062	7814062	7826062	7813062	7812062	7821062		2,380
OZKU060508SR-GR	16	17.1	5.66	6	3°	0.8	2							7812086	7821086		2,380
OZKU060508ER-SM	16	17.1	5.66	6	3°	0.8	2									7816085	4,630

ワイパーインサート
取付け例
How to install wiper inserts

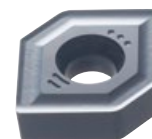
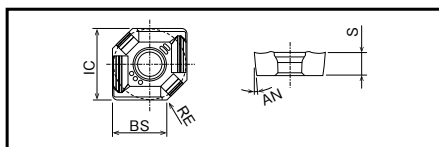
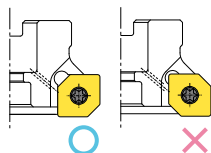

■ワイパーインサート Wiper Insert

単位:mm Unit:mm

呼び Designation	切れ刃数 No. of Cutting Edges	インサート寸法 Insert Size					コーティング材種 Grade of Coated Materials		標準価格 (Yen)
		内接円径 IC	厚さ S	ざらい刃 (副切れ刃) BS	逃げ角 AN	RE	XP3035	XC1015	
XAHT060525SR-GM	2	17.1	5.56	10	3°	2.5	7814064	7812064	2,940

Accessories

■部品 Accessories

部品	ソールNo. EDP No.	呼び Designation	適用ボディ Applicable Body
クランプねじ Clamping Screw	7808130	FS50614 (Torx 20)	PAO BORE φ50~125
パワースクリュー Power Screw	7808151	PS1031 (M10×31)	PAO BORE φ50
ウェッジ Wedge	7808141	W12F-06N (M6)	PAO BORE (W) φ100~200
ウェッジ用クランプねじ Clamping Screw for Wedge	7808140	WS0621T (M6×21)	PAO BORE (W) φ100~200

部品	ソールNo. EDP No.	呼び Designation	適用ボディ Applicable Body	標準価格 (Yen)
レンチ Wrench	7808208	T15-D (Torx 15)	PAO BORE (W) φ100~200	1,260
	7808209	T20-D (Torx 20)	PAO BORE φ50~125	1,260

レンチは別途ご購入下さい。 The wrenches are sold separately from the cutters.

Cutting Conditions

被削材別推奨材質

Recommended Materials by Insert Type

◎第一推奨材質 Best
○第二推奨材質 Good

インサート材種 Insert Grades	ブレーカ Insert Breaker	切削油剤 Coolant	P	M	K		N	S	H
					FC	FCD			
XC3020	GL GM	無 Dry	◎			○			
XP3025	GL GM	有 Wet	◎			○			
XC3030	GL GM	無 Dry	◎			○			
XP3035	GL	無 Dry	◎	○	○				
	GM	有 Wet							
XP2025	GL	有 Wet	○	◎				○	
	GM								
XP2040	GL	無 Dry	○	◎					○
	GM	有 Wet							
XC1015	GM GR	無 Dry			◎	○			
XP1020	GM GR	無 Dry			○	◎			
XC5040	SM	有 Wet		○				◎	

GL: 軽切削用 GM: 中切削用 GR: 重切削用 SM: 耐熱合金用
GL: Light Cutting GM: Middle Cutting GR: Heavy Cutting SM: Heat Resistant Alloy

切削条件基準表 Cutting Conditions

	被削材 Work Material	引張強さ・硬さ Tensile Strength・Hardness	切削速度 Vc(m/min) Cutting Speed	一刃当たりの送り量 fz (mm/t) Feed per Tooth	切込深さ ap (mm) Depth of Cut
P	軟鋼、低炭素鋼 Mild Steel, Carbon Steel (S5400, S10C)	~180HB	180 (100 ~ 250)	0.25 (0.2 ~ 0.5)	2
	炭素鋼、合金鋼 Carbon Steel, Alloy Steel (S50C, SCM440)	~280HB	180 (100 ~ 250)	0.25 (0.2 ~ 0.5)	2
	ダイス鋼 Die Steel (SKD11, SKD61)	~280HB	150 (80 ~ 200)	0.25 (0.15 ~ 0.4)	2
M	ステンレス鋼(湿式) Stainless Steel (Wet) (SUS304, SUS420)	~250HB	120 (80 ~ 180)	0.2 (0.15 ~ 0.4)	2
K	鑄鉄 Cast Iron (FC250)	~300N/mm ²	200 (100 ~ 350)	0.3 (0.2 ~ 0.5)	2
	ダクタイル鑄鉄 Ductile Cast Iron (FCD400)	~600N/mm ²	180 (100 ~ 270)	0.28 (0.15 ~ 0.4)	2
S	耐熱合金 Heat Resistant Alloy (Inconel 718)	-	35 (25 ~ 60)	0.12 (0.05 ~ 0.2)	1
	チタン合金 Titanium Alloy (Ti-6Al-4V)	-	40 (30 ~ 120)	0.15 (0.1 ~ 0.25)	1.5
H	プリハードン鋼 Pre-hardened Steel (NAK80)	40~43HRC	100 (60 ~ 150)	0.15 (0.1 ~ 0.25)	1.5
	ダイカスト用鋼 Steel for Die Casting (DAC-MAGIC, DH31)	43~48HRC	80 (40 ~ 120)	0.12 (0.05 ~ 0.2)	0.5
	調質鋼 Hardened Steel (SKD11)	50~60HRC	60 (40 ~ 90)	0.1 (0.05 ~ 0.2)	0.5

上記の数値は実切削速度における一般的な値を示したものです。加工環境に合わせて適宜調整して下さい。
The above cutting conditions are to be used as general guidelines. Adjustments may be necessary depending on actual cutting condition.

Cutting Data

加工データ Cutting Data

油圧バルブ部品の荒取り加工 Rough milling of hydraulic valve parts

使用工具 Tool	PAO06R160M50.8W-20 (φ160×20刃)	他社品 Competitor
使用インサート(材種) Insert (grade)	OZKU060508SR-GM (XC1015)	超硬コーティングインサート Coated Carbide Insert
被削材 Work Material	FCD600	
切削速度 Cutting Speed	250m/min (500min ⁻¹)	
送り速度 Feed	3,000mm/min (0.3mm/t)	
切込深さ Depth of Cut	ap=3mm ae=120mm	
切削油剤 Coolant	なし(エアブロー) Air Blow	
使用機械 Machine	立形マシニングセンタ(BT50) Vertical Machining Center	

	加工ワーク数 Number of Processed Workpiece			
	5	10	15	20
PAO				
他社品 Competitor				

ワーク形状は穴が多数あり厳しい断続加工であった。そのような加工環境での高速条件下においても安定した加工が可能で、1コーナあたりの耐久も大幅UPとなり、コストダウンが期待できる結果となった。

The workpiece, on which had multiple holes, required intermitted machining. However, this product enabled stable machining under the high speed condition and better durability per cutting edge, which will contribute to cost reduction.

16ワーク加工後のインサート写真 After 16 workpieces of milling



主切れ刃部摩耗 Wear on main cutting edge

機械部品の荒取り加工 Roughing of machinery parts

使用工具 Tool	PAO06R125M38.1-12 (φ125×12刃)	他社品 Competitor
使用インサート(材種) Insert (grade)	OZKU060508SR-GM (XC1015)	超硬コーティングインサート Coated Carbide Insert
被削材 Work Material	FC250	
切削速度 Cutting Speed	200m/min (500min ⁻¹)	157m/min (400min ⁻¹)
送り速度 Feed	1,800mm/min (0.3mm/t)	1,000mm/min (0.3mm/t)
切込深さ Depth of Cut	ap=2mm ae=90mm	
切削油剤 Coolant	なし(エアブロー) Air Blow	
使用機械 Machine	門形マシニングセンタ(BT50) Double Column Machining Center	

	加工ワーク数 Number of Processed Workpiece			
	1	2	3	4
PAO				
他社品 Competitor				

切削抵抗を低く抑えられるため能率を1.8倍に上げての安定加工が可能。さらに1.5倍の耐久が得られた。

By reducing cutting resistance, efficiency can be increased by 1.8 times and tool life can be prolonged 1.5 times.

油圧バルブの荒取り加工 Roughing of oil pressure valve

使用工具 Tool	PAO06R125M38.1-12 (φ125×12刃)	他社品 Competitor
使用インサート(材種) Insert (grade)	OZKU060508SR-GM (XC1015)	超硬コーティングインサート Coated Carbide Insert
被削材 Work Material	FCD500	
切削速度 Cutting Speed	150m/min (380min ⁻¹)	150m/min (300min ⁻¹)
送り速度 Feed	900mm/min (0.2mm/t)	720mm/min (0.27mm/t)
切込深さ Depth of Cut	ap=3mm ae=50~80mm	
切削油剤 Coolant	なし(エアブロー) Air Blow	
使用機械 Machine	門形マシニングセンタ(BT50) Double Column Machining Center	

	加工ワーク数 Number of Processed Workpiece			
	4	8	12	16
PAO				
他社品 Competitor				

従来は片面8コーナ仕様タイプを使用していたが、PAOでは使用可能コーナ数が2倍となりコーナ単価ダウン。また切削量25%UPが可能で、耐久は2倍となった。

The 8-corner type has been used previously, but with the PAO, the amount of milled materials can be increased by 25 percent, with twice as much tool life. In addition, the number of corners has also doubled, leading to a decrease in tooling cost.

Inconel 718の長寿命加工 Long tool life on Inconel 718

使用工具 Tool	PAO06R125M38.1-12 (φ125×12刃)	他社品 Competitor
使用インサート(材種) Insert (grade)	OZKU060508ER-SM (XC5040)	両面仕様インサート Double-sided Insert
被削材 Work Material	Inconel 718	
切削速度 Cutting Speed	40m/min (100min ⁻¹)	
送り速度 Feed	120mm/min (0.1mm/t)	
切込深さ Depth of Cut	ap=1.5mm ae=50mm	
切削油剤 Coolant	水溶性切削油剤 Water-Soluble	
使用機械 Machine	立形マシニングセンタ(BT50) Vertical Machining Center	



他社品は早期にてチッピング・欠損が発生していたが、PAO(XC5040)では摩耗の抑制により約4倍の耐久UPが可能であった。

The competitor tool exhibited chipping and breakage at an early stage. In contrast, the PAO (XC5040) demonstrated strong resistance to wear and achieved four times the durability versus the competition.

プレス金型基準面荒取り加工 Die mold surface, rough milling

使用工具 Tool	PAO06R100M31.7-10 (φ100×10刃)
使用インサート(材種) Insert (grade)	OZKU060508SR-GR (XC1015)
被削材 Work Material	FCD500相当 Equivalent
切削速度 Cutting Speed	150m/min (477min ⁻¹)
送り速度 Feed	1,400mm/min (0.3mm/t)
切込深さ Depth of Cut	ap=3mm ae=60mm
切削油剤 Coolant	なし(エアブロー) Air Blow
使用機械 Machine	門形マシニングセンタ(BT50) Double Column Machining Center
加工時間 Milling Time	2時間30分 Hours Minutes

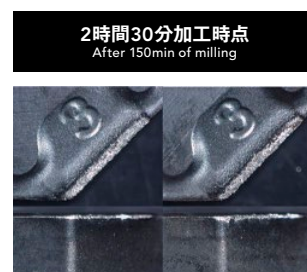
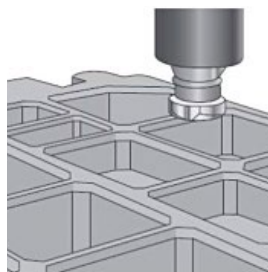

従来品では激しい断続加工と被削性の悪さから欠損が多発していた。高剛性GRプレーカでは安定加工・耐久UPが可能となった。

Excessive tool wear is a challenge for demanding intermittent milling and difficult-to-machine materials. OSG's rigid GR insert breaker ensures stable milling and prolongs durability.

» Phoenix PSF

4コーナ肩削りカッタシリーズ
4-corner Shoulder Cutter Series

Phoenix Shoulder Face Milling



■ インサート形状 Insert form

- 4コーナ仕様：ポジ正方形タイプインサート
Four-corner type: Positive square type insert
- 低切込みに適した小型インサート(9.07×9.07mm)
Compact size insert for low depth of cut
- 3次元ブレーカインサートのシャープな切れ味により、低抵抗加工が実現！
The sharpness of the three-dimensional breaker insert enables low-resistance milling!

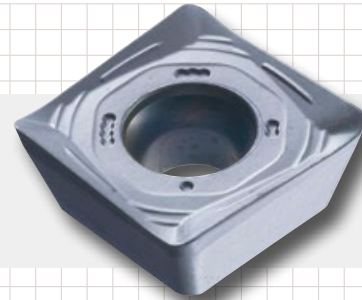

■ 小型マシニングセンタでの加工に最適

Optimal for milling with compact machining center

— 低切込み (ap=3mm 以下) 領域で優れた性能を発揮

Superior performance for short cutting depths (ap = 3mm or less).

- ・長寿命 Long tool life
- ・高能率 High efficiency

— 多いコーナ数で高いコストパフォーマンス Multiple corners for high cost performance

- ・4コーナ使用時 最大切込み5mm (Using 4 corners - maximum cutting depth 5mm)
- (2コーナ使用時 最大切込み8mm) (Using 2 corners - maximum cutting depth 8mm)

■ PSEとの使い分け Difference in use from the PSE

		コーナ数 Number of Corners	コスト Cost	加工精度(側面) Milling Accuracy (side)	多機能性 Multiple Functions
	PSF 平面加工に最適 Optimal for plane milling	4	◎	△	○
	※1 PSE 多機能加工に最適 (ヘリカル・ランピング加工等) Optimal for multiple functions (helical, ramping, etc.)	2	△	○	◎

※1 肩削りカッタ(PSE)の詳細はp.103を参照下さい。 ※1 For details on the Phoenix shoulder cutters (PSE), please refer to p.103

■ 豊富なインサートバリエーション A wide variety of Inserts

ブレーカ Insert Breaker	NM	GL	GM	GR
用途 Application	アルミニウム合金・非鉄金属加工 Aluminum alloy & Non-ferrous metal	低抵抗加工 耐熱合金・難削材加工 Low-resistance machining-Heat-resistant alloy & Difficult-to-machine material	汎用加工 一般鋼加工 Multi-purpose machining & General steel milling	断続加工 鋳鉄加工 Intermittent machining & Cast iron machining
				

Phoenix Specification

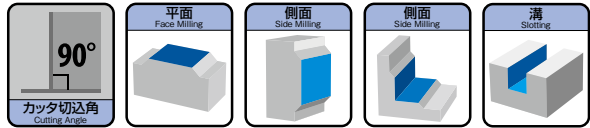

■形状寸法表 Specification

4コーナ肩削りカッタ ストレートシャンクタイプ

4-corner Shoulder Cutter with Straight Shank

PSF SS

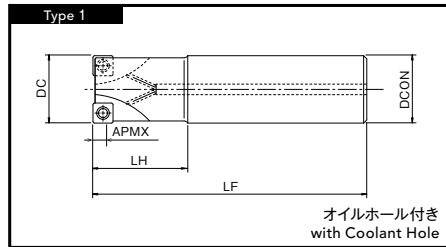

オイルホール付き
with Coolant Hole

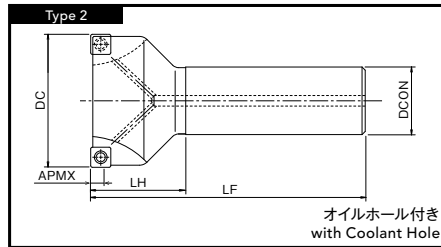

オイルホール付き
with Coolant Hole



単位:mm Unit:mm

ツールNo. EDP No.	呼び Designation	外径 DC	刃数 ZEFP	シャンク径 DCON	全長 LF	首下長 LH	APMX	重量 (kg)	形状タイプ Type	標準価格 (Yen)
7803001	PSF09R025SS25-3S	25	3	25	120	35	5	0.4	1	43,600
7803002	PSF09R032SS32-4S	32	4	32	130	45	5	0.72	1	56,100
7803003	PSF09R040SS32-5S	40	5	32	140	50	5	0.88	2	71,200

4コーナ肩削りカッタ ボアタイプ

4-corner Shoulder Cutter with Bore Type

PSF BORE

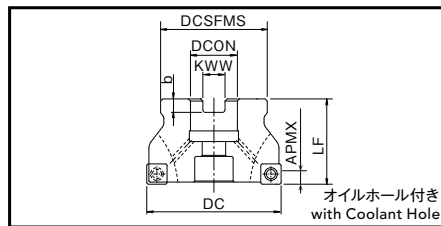

オイルホール付き
with Coolant Hole



単位:mm Unit:mm

ツールNo. EDP No.	呼び Designation	外径 DC	刃数 ZEFP	カッタ 高さ LF	ボス径 DCSFMS	穴径 DCON	端面キー溝 Key Slot		APMX	重量 (kg)	標準価格 (Yen)
							幅 KWW	深さ b			
7803011	PSF09R050M22-6	50	6	40	45	22	10.4	6.3	5	0.3	73,300
7803012	PSF09R063M22-7	63	7	40	50	22	10.4	6.3	5	0.5	84,600
7803013	PSF09R080M25.4-9	80	9	50	60	25.4	9.5	6	5	1.02	98,900

Inserts

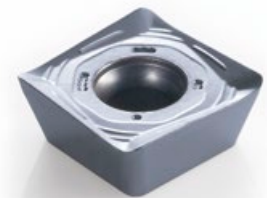
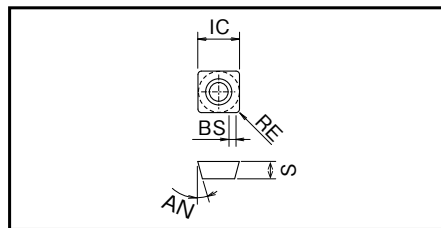

単位:mm Unit:mm

■適用インサート Inserts

呼び Designation	切れ刃数 No. of Cutting Edges	インサート寸法 Insert Size					さらい刃 (副切れ刃) BS	超硬 Uncoated CK010	コーティング材種 Grade of Coated Materials					標準価格 (Yen)
		IC	厚さ S	逃げ角 AN	RE	さらい刃 (副切れ刃) BS			XC3030	XP3035	XP2040	XC1015	XC5040	
SDHT09T308FR-NM	4	9.07	3.97	15°	0.8	2.5	7811076	-	-	-	-	-	1,950	
SDKT09T308SR-GL	4	9.07	3.97	15°	0.8	2.5	-	7825073	7814073	7813073	-	-	1,310 2,380	
SDKT09T308SR-GM	4	9.07	3.97	15°	0.8	2.5	-	7825074	7814074	7813074	-	-	1,310	
SDKT09T308SR-GR	4	9.07	3.97	15°	0.8	2.5	-	-	-	-	7812075	-	1,310	

Phoenix

4コーナー肩削りカッタシリーズ

4-corner Shoulder Cutter Series

PSF

Accessories

■部品 Accessories

	ツールNo. EDP No.	呼び Designation	適用ボディ Applicable Body
 クランプねじ Clamping Screw	7808110	FS30573 (Torx 8)	PSF SS φ25~40 PSF BORE φ50~80

	ツールNo. EDP No.	呼び Designation	適用ボディ Applicable Body	標準価格 (Yen)
 レンチ Wrench	7808205	T8-D (Torx 8)	PSF SS φ25~40 PSF BORE φ50~80	1,190

レンチは別途ご購入下さい。 The wrenches are sold separately from the cutters.

Cutting Conditions

■被削材別推奨材質

Recommended Materials by Insert Type

◎第一推奨材質 Best

○第二推奨材質 Good

インサート材種 Insert Grades	ブレーカ Insert Breaker	切削油剤 Coolant	P	M	K	N	S	H
CK010	NM	有 Wet				◎		
XC3030	GL GM	無 Dry	◎		○			
		有 Wet	◎	○	○			
XP3035	GL GM	無 Dry	◎	○	○			
		有 Wet	◎	◎			○	
XP2040	GL GM	無 Dry	○	○				○
		有 Wet	○	◎			○	
XC1015	GR	無 Dry			◎			
XC5040	GL	有 Wet		○			◎	

NM:アルミニウム合金用 GL:軽切削用 GM:中切削用 GR:重切削用
NM:Aluminum Alloy GL:Light Cutting GM:Middle Cutting GR:Heavy Cutting

■切削条件基準表 Cutting Conditions

	被削材 Work Material	引張強さ・硬さ Tensile Strength・Hardness	切削速度 Vc (m/min) Cutting Speed	一刃当たりの送り量 fz (mm/t) Feed per Tooth	切込深さ ap (mm) Depth of Cut
P	軟鋼、低炭素鋼 Mild Steel, Carbon Steel (SS400, S10C)	~180HB	180 (100 ~ 250)	0.12 (0.05 ~ 0.2)	3
	炭素鋼、合金鋼 Carbon Steel, Alloy Steel (S50C, SCM440)	~280HB	180 (100 ~ 250)	0.12 (0.05 ~ 0.2)	3
	ダイス鋼 Die Steel (SKD11, SKD61)	~280HB	150 (80 ~ 200)	0.1 (0.05 ~ 0.18)	3
M	ステンレス鋼(乾式) Stainless Steel (Dry) (SUS304, SUS420)	~250HB	150 (80 ~ 200)	0.1 (0.05 ~ 0.18)	2
	ステンレス鋼(湿式) Stainless Steel (Wet) (SUS304, SUS420)	~250HB	80 (60 ~ 120)	0.1 (0.05 ~ 0.18)	2
K	鑄鉄 Cast Iron (FC250)	~350N/mm ²	180 (100 ~ 350)	0.12 (0.05 ~ 0.2)	3
	ダクタイル鑄鉄 Ductile Cast Iron (FCD400)	~800N/mm ²	180 (100 ~ 270)	0.12 (0.05 ~ 0.2)	3
N	アルミニウム合金 Aluminum Alloy	~13%Si	300 (200 ~ 1,500)	0.15 (0.1 ~ 0.25)	3
S	超耐熱合金(湿式) Superalloy (Wet) (Inconel 718)	-	35 (25 ~ 60)	0.1 (0.05 ~ 0.15)	1.5
	チタン合金(湿式) Titanium Alloy (Wet) (Ti-6Al-4V)	-	40 (30 ~ 120)	0.1 (0.05 ~ 0.18)	1.5
H	プリハードン鋼 Pre-hardened Steel (NAK80)	40~43HRC	90 (40 ~ 150)	0.1 (0.08 ~ 0.2)	1.5
	ダイカスト用鋼 Steel for Die Casting (DAC-MAGIC, DH31)	43~48HRC	70 (40 ~ 120)	0.08 (0.06 ~ 0.15)	0.5
	調質鋼 Hardened Steel (SKD11)	50~55HRC	50 (40 ~ 90)	0.06 (0.05 ~ 0.1)	0.5

上記の数値は実切削速度における一般的な値を示したものです。加工環境に合わせて適宜調整して下さい。
The above cutting conditions are to be used as general guidelines. Adjustments may be necessary depending on actual cutting condition.

Cutting Data

加工データ Cutting Data

耐食装置(二相ステンレス)加工 Anticorrosion equipment (duplex stainless steel) milling

使用工具 Tool	PSF09R025SS25-3S (φ25×3刃)	他社品 Competitor
使用インサート(材種) Insert (grade)	SDKT09T308SR-GL (XC5040)	超硬コーティングインサート Coated Carbide Insert
被削材 Work Material	二相ステンレス Duplex Stainless Steel	
切削速度 Cutting Speed	80m/min (800min ⁻¹)	
送り速度 Feed	300mm/min (0.1mm/t)	
切込深さ Depth of Cut	ap=2mm ae=15mm	
切削油剤 Coolant	水溶性切削油剤 Water-Soluble	
使用機械 Machine	立形マシニングセンタ(BT50) Vertical Machining Center	

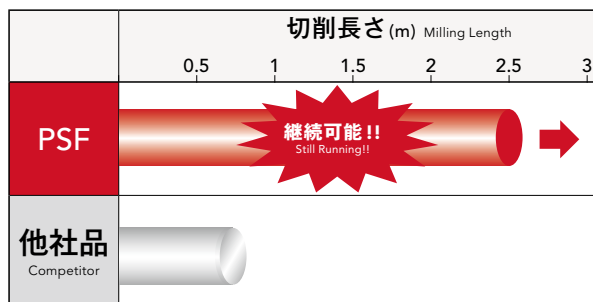

他社品は早期にチッピングが発生し、加工が難しい状況であったが、PSF(XC5040)では安定した長寿命加工が可能であった。
The competitor's product became chipped early on, making it difficult to mill. However, the PSF (XC5040) could mill in a stable manner, resulting in a long tool life.

半導体装置部品(SUS304)加工 Semi-conductor equipment parts (SUS304) milling

使用工具 Tool	PSF09R050M22-6 (φ50×6刃)	他社品 Competitor
使用インサート(材種) Insert (grade)	SDKT09T308SR-GL (XP2040)	超硬コーティングインサート Coated Carbide Insert
被削材 Work Material	SUS304	
切削速度 Cutting Speed	160m/min (1,000min ⁻¹)	
送り速度 Feed	1,200mm/min (0.2mm/t)	
切込深さ Depth of Cut	ap=2mm ae=30mm	
切削油剤 Coolant	なし(エアブロー) Air Blow	
使用機械 Machine	立形マシニングセンタ(BT50) Vertical Machining Center	

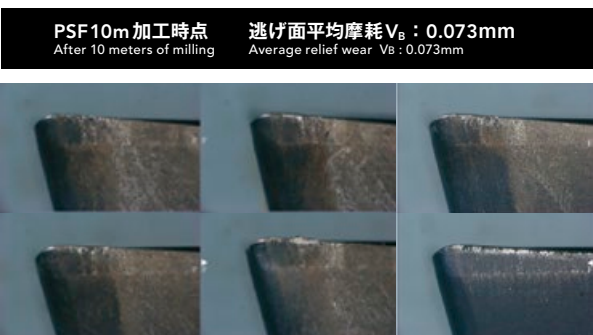

10m加工時、他社品はチッピングが発生し継続加工不可であった。PSFは正常摩耗(小)により継続加工が可能で、他社品より耐久が50%以上UPした。
After milling 10 meters, the competitor's product became chipped, without being able to continue milling. The PSF exhibited normal (slight) wear, was able to continue milling, with durability increased by 50%.

優れた加工面粗さ Superior milling surface roughness

使用工具 Tool	PSF09R050M22-6 (φ50×6刃)
使用インサート(材種) Insert (grade)	SDKT09T308SR-GL (XP2040)
被削材 Work Material	SUS304
切削速度 Cutting Speed	150m/min (955min ⁻¹)
送り速度 Feed	570mm/min (0.1mm/t)
切込深さ Depth of Cut	ap=0.2mm ae=32mm
切削油剤 Coolant	水溶性切削油剤 Water-Soluble
使用機械 Machine	横形マシニングセンタ(BT50) Horizontal Machining Center

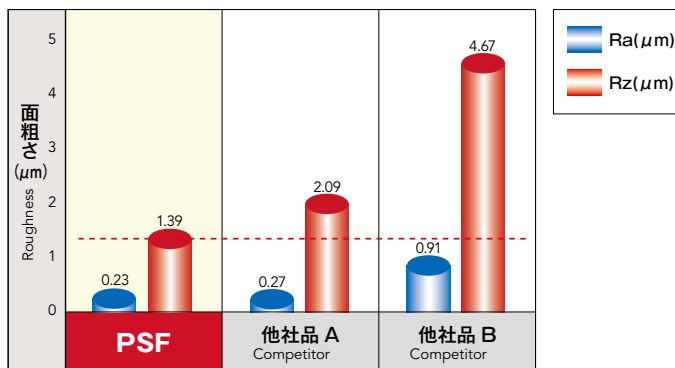

» Phoenix PSFL

4コーナラフィングエンドミルシリーズ
4-Corner Roughing End Mill Series

Phoenix Shoulder Long Edge End Mill



■ 特殊なボディ設計で高い防振効果

Special body design prevents vibration



PAT.P in Japan

・不等リードインサート配列 Unequal lead alignment

1, 2段目 First and second rows

2, 3段目 Second and third rows

3, 4段目 Third and fourth rows

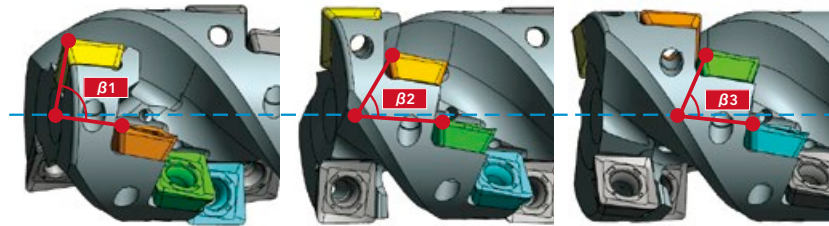

$$\beta_1 \neq \beta_2 \neq \beta_3$$

・不等分割 Unequal spacing teeth

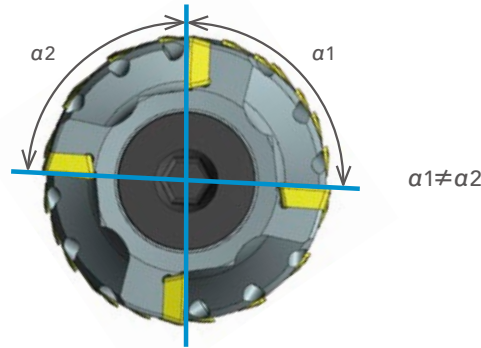

$$\alpha_1 \neq \alpha_2$$

・特殊ボディの防振効果によりびびりを抑制

The anti-vibration feature of the special body design enables the suppression of chattering

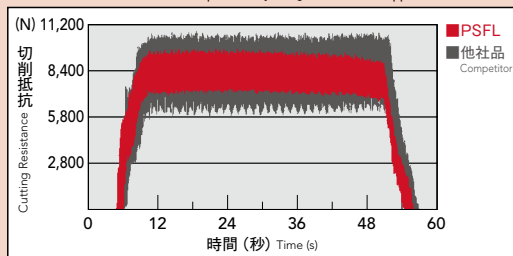

工具: PSFL09R050M27-4-78 (φ50x4刃) 被削材: Ti-6Al-4V
Tool Flutes Work Material

切削条件 Cutting Conditions
Vc=60m/min (n=382min⁻¹) Vf=230mm/min (fz=0.15mm/t)
ap=78mm ae=10mm 水溶性切削油剤(内部給油)
Water-Soluble (Internal)

使用機械: 横形マシニングセンタ(BT50)
Machine Horizontal Machining Center

・びびり抑制により、能率1.5倍の高効率加工を実現

High productivity milling with 1.5 times efficiency

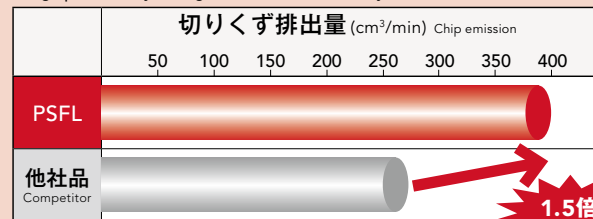

工具: PSFL12R063M27-4-100 (φ63x4刃) 被削材: FC300
Tool Flutes Work Material

切削条件 Cutting Conditions
Vc (PSFL) =180m/min (n=910min⁻¹) Vf (PSFL) =910mm/min (fz=0.25mm/t)
Vc (他社品) =150m/min (n=758min⁻¹) Vf (他社品) =606mm/min (fz=0.2mm/t)

ap=60mm ae=7mm エアブロー
Air Blow

使用機械: 横形マシニングセンタ(BT50)
Machine Horizontal Machining Center

■ 経済的な高耐久性4コーナインサート Economical high durability 4-corner insert

3次元ブレーカインサートのシャープな切れ味と大きなポジすくい角で切削抵抗を低減
 The 3-dimensional breaker insert's sharp cutting edge and large positive rake angle reduce cutting resistance



共通インサート Interchangeable

09サイズはPSFと同じインサートが使える、管理が簡単
 Enables to simplify tool management, as inserts for PSFL are interchangeable with those for PSF09.

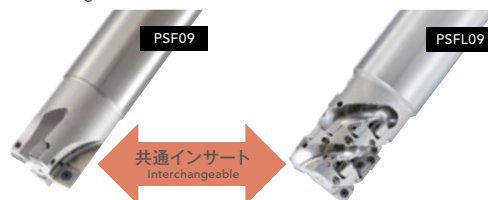

・PSFL(4コーナ)と他社品(2コーナ)の加工可能ワーク数比較
 Comparison of processed workpieces of PSFL (4-corner) versus competitor product (2-corner)

使用工具 Tool	PSFL12R080M32-5-110 (φ80×5刃) Flutes	他社ラフィングカッタ Competitor's Roughing Cutter (φ80×5刃) Flutes
使用インサート(材種) Insert (grade)	SDKT120508SR-GM (XP3035)	超硬コーティングインサート (2コーナタイプ) Coated Carbide Insert (2-corner Type)
被削材 Work Material	SS400	
切削速度 Cutting Speed	180m/min(720min ⁻¹)	
送り速度 Feed	400mm/min(0.11mm/t)	
切込深さ Depth of Cut	ap=85mm ae=10mm	
切削油剤 Coolant	水溶性切削油剤(内部給油) Water-Soluble (Internal)	
使用機械 Machine	横形マシニングセンタ(BT50) Horizontal Machining Center	

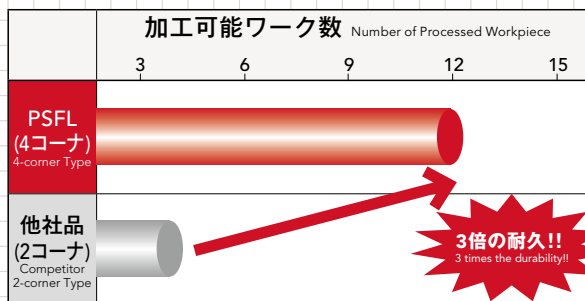

(インサート耐久性) × (コーナ数) = 3倍の耐久!!
 Insert durability × Number of corners = 3 times the durability!!
 1.5倍* × 2倍 = 3倍の耐久!!
 1.5 times 2 times 3 times the durability!!

*インサート材種及び特殊ボディの防振効果による
 Due to grade of insert and anti-vibration feature of the special body design.

■ 一般鋼から難削材まで幅広い被削材に対応する材種をラインナップ Insert variations to accommodate a wide range of work materials - from general steel to difficult-to-machine materials

ブレーカ Insert Breaker	NM	GL	GM	GR
用途 Application	アルミニウム合金 非鉄金属加工 Aluminum alloy & Non-ferrous metal	低抵抗加工 耐熱合金・難削材加工 Low-resistance machining·Heat-resistant alloy & Difficult-to-machine material	汎用加工 一般鋼加工 Multi-purpose machining & General steel milling	断続加工 鋳鉄加工 Intermittent machining & Cast iron machining

Phoenix Specification

■形状寸法表 Specification

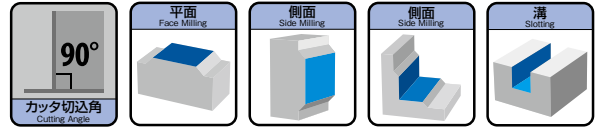

4コーナラフィングエンドミル ストレートシャンクタイプ 4-Corner Roughing End Mill Straight Shank Type

PSFL SS

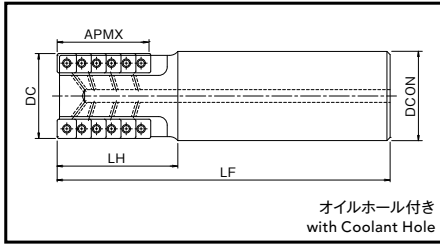

単位:mm Unit:mm

ツールNo. EDP No.	呼び Designation	外径 DC	刃数 ZEPF	刃段数 No. of Insert per Flute	総インサート数 Total No. of Inserts	刃長 APMX	シャンク径 DCON	全長 LF	首下長 LH	重量 (kg)	適用インサート Applicable Inserts	在庫 Stock	標準価格 (Yen)
7803700	PSFL09R032SS32-2-36	32	2	5	10	36	32	140	60	0.71	①	C	86,600
7803701	PSFL09R040SS42-3-43	40	3	6	18	43	42	140	60	1.17		C	110,000

C=標準在庫品 C=Standard stock item

4コーナラフィングエンドミル ボアタイプ 4-Corner Roughing End Mill Bore Type

PSFL BORE

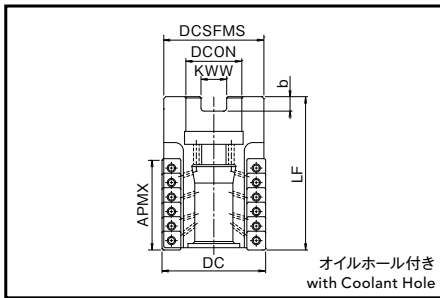

単位:mm Unit:mm

ツールNo. EDP No.	呼び Designation	外径 DC	刃数 ZEPF	刃段数 No. of Insert per Flute	総インサート数 Total No. of Inserts	刃長 APMX	カット 高さ LF	ボス径 DCSFMS	穴径 DCON	端面キー溝 Key Slot		重量 (kg)	適用インサート Applicable Inserts	在庫 Stock	標準価格 (Yen)
										幅 KWW	深さ b				
7803702	PSFL09R050M22-4-50	50	4	7	28	50	75	48.5	22	10.4	6.3	0.53	①	C	170,000
7803703	PSFL09R050M22-4-78	50	4	11	44	78	100	48.5	22	10.4	6.3	0.71		C	267,000
7803704	PSFL09R050M27-4-50	50	4	7	28	50	75	48.5	27	12.4	7	0.53		C	170,000
7803705	PSFL09R050M27-4-78	50	4	11	44	78	100	48.5	27	12.4	7	0.71		C	267,000
7803706	PSFL12R063M27-4-60	63	4	6	24	60	85	60.5	27	12.4	7	0.88	②	C	145,000
7803707	PSFL12R063M27-4-100	63	4	10	40	100	125	60.5	27	12.4	7	1.26		C	241,000
7803708	PSFL12R080M32-5-70	80	5	7	35	70	95	77.3	32	14.4	8	1.88		C	211,000
7803709	PSFL12R080M32-5-110	80	5	11	55	110	143	77.3	32	14.4	8	2.96		C	332,000
7803710	PSFL12R100M32-6-120	100	6	12	72	120	153	97	32	14.4	8	4.95		※	434,000

C=標準在庫品 C=Standard stock item
※=受注対応品 ※=Special order item

Inserts

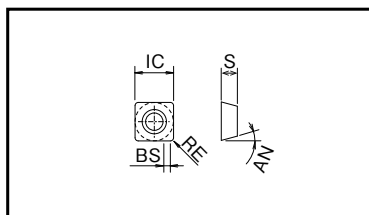

■適用インサート Inserts



単位:mm Unit:mm

呼び Designation	切れ刃数 No. of Cutting Edges	インサート寸法 Insert Size						超硬 Uncoated	コーティング材種 Grade of Coated Materials					標準価格 (Yen)
		IC	厚さ S	逃げ角 AN	RE	さらい刃 (副切れ刃) BS	CK010	XC3030	XP3035	XP2040	XC1015	XC5040		
① SDHT09T308FR-NM	4	9.07	3.97	15°	0.8	2.5	7811076						1,950	
	4	9.07	3.97	15°	0.8	2.5		7825073	7814073	7813073			1,310	
	4	9.07	3.97	15°	0.8	2.5						7816073	2,380	
	4	9.07	3.97	15°	0.8	2.5		7825074	7814074	7813074			1,310	
② SDHT120508FR-NM	4	12.38	5	15°	0.8	1.2	7811625						2,950	
	4	12.38	5	15°	0.8	1.2				7813623			2,190	
	4	12.38	5	15°	0.8	1.2						7816620	2,830	
	4	12.38	5	15°	0.8	1.2		7825622	7814621				2,190	
	4	12.38	5	15°	0.8	1.2					7812624		2,190	

在庫区分は全てC(標準在庫品)となります。 Stock are categorized as C (standard stock item).

Accessories

■部品 Accessories

	ツールNo. EDP No.	呼び Designation	適用インサート Applicable Inserts	適用ボディ Applicable Body
 クランプねじ Clamping Screw	7808110	FS30573 (Torx 8)	① SD*T09...	PSFL SS φ32, φ40 PSFL BORE φ50
	7808129	FS40511 (Torx 15)	② SD*T12...	PSFL BORE φ63~100
 クーラントキャップボルト Coolant cap bolt	7808132	OCB-M20-08	-	PSFL BORE φ50
	7808133	OCB-M24-10	-	PSFL BORE φ63
	7808134	OCB-M30-14	-	PSFL BORE φ80, φ100

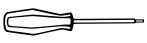
	ツールNo. EDP No.	呼び Designation	適用インサート Applicable Inserts	適用ボディ Applicable Body	標準価格 (Yen)
 レンチ Wrench	7808205	T8-D (Torx 8)	① SD*T09...	PSFL SS φ32, φ40 PSFL BORE φ50	1,190
	7808208	T15-D (Torx 15)	② SD*T12...	PSFL BORE φ63~100	1,260

在庫区分は全てC(標準在庫品)となります。 Stock are categorized as C (standard stock item).
レンチは別途ご購入下さい。 The wrenches are sold separately from the cutters.

Phoenix

4コーナラフィングエンドミル

4-Corner Roughing End Mill

PSFL

■被削材別推奨材質 Recommended Materials by Insert Type

◎第一推奨材質 Best
○第二推奨材質 Good

インサート材質 Insert Grades	ブレーカ Insert Breaker	切削油剤 Coolant	P	M	K	N	S	H	インサート材質 Insert Grades	ブレーカ Insert Breaker	切削油剤 Coolant	P	M	K	N	S	H
CK010	NM	有 Wet				◎			XP2040	GL GM	無 Dry 有 Wet	○ ○	○ ◎				○
XC3030	GL GM	無 Dry	◎		○				XC1015	GR	無 Dry			◎			
XP3035	GL GM	無 Dry	◎	○	○				XC5040	GL	有 Wet		○			◎	
		有 Wet															

NM:アルミニウム合金用 GL:軽切削用 GM:中切削用 GR:重切削用
NM:Aluminum Alloy GL:Light Cutting GM:Middle Cutting GR:Heavy Cutting

切込深さ(ap) 1.1~1.5D、
切込幅(ae) 0.1D以下での条件表です。
The chart below is based on the following condition:
-Depth of Cut (ap) : between 1.1D to 1.5D
-Cutting Width (ae) ≤0.1D

Cutting Conditions

■切削条件基準表 Cutting Conditions

被削材 Work Material	引張強さ・硬さ 成分等 Tensile Strength Hardness	インサートサイズ Insert Size			
		SD*T09...		SD*T12...	
		切削速度 Vc (m/min) Cutting Speed	一刃当たりの 送り量 fz (mm/t) Feed Per Tooth	切削速度 Vc (m/min) Cutting Speed	一刃当たりの 送り量 fz (mm/t) Feed Per Tooth
P 軟鋼、低炭素鋼 Mild Steel, Carbon Steel (S450, S10C) 炭素鋼、合金鋼 Carbon Steel, Alloy Steel (S50C, SCM440) ダイス鋼 Die Steel (SKD11, SKD61)	~180HB	160 (100 ~ 200)	0.25 (0.2 ~ 0.4)	160 (100 ~ 200)	0.3 (0.2 ~ 0.4)
	~280HB	150 (100 ~ 200)	0.2 (0.15 ~ 0.3)	150 (100 ~ 200)	0.25 (0.15 ~ 0.3)
	~280HB	130 (80 ~ 180)	0.2 (0.15 ~ 0.3)	130 (80 ~ 180)	0.25 (0.15 ~ 0.3)
M ステンレス鋼(乾式) Stainless Steel (Dry) (SUS304, SUS420) ステンレス鋼(湿式) Stainless Steel (Wet) (SUS304, SUS420)	~250HB	150 (100 ~ 200)	0.12 (0.1 ~ 0.3)	150 (100 ~ 200)	0.15 (0.1 ~ 0.3)
	~250HB	80 (60 ~ 120)	0.12 (0.1 ~ 0.3)	80 (60 ~ 120)	0.15 (0.1 ~ 0.3)
K 鋳鉄 Cast Iron (FC250) ダクタイル鋳鉄 Ductile Cast Iron (FCD400)	~350N/mm ²	160 (100 ~ 300)	0.2 (0.15 ~ 0.35)	160 (100 ~ 300)	0.25 (0.2 ~ 0.4)
	~800N/mm ²	160 (100 ~ 250)	0.2 (0.15 ~ 0.3)	160 (100 ~ 250)	0.2 (0.15 ~ 0.35)
N アルミニウム合金 Aluminum Alloy	~13%Si	300 (200 ~ 1,000)	0.25 (0.1 ~ 0.4)	300 (200 ~ 1,000)	0.3 (0.1 ~ 0.4)
S 超耐熱合金(湿式) Superalloy (Wet) (Inconel 718) チタン合金(湿式) Titanium Alloy (Wet) (Ti-6Al-4V)	-	35 (25 ~ 60)	0.15 (0.08 ~ 0.3)	35 (25 ~ 60)	0.18 (0.1 ~ 0.3)
	-	40 (30 ~ 120)	0.15 (0.08 ~ 0.3)	40 (30 ~ 120)	0.18 (0.1 ~ 0.3)
H プリハードン鋼 Pre-hardened Steel (NAK80) ダイカスト用鋼 Steel for Die Casting (DAC-MAGIC, DH31)	40~43HRC	100 (40 ~ 150)	0.15 (0.08 ~ 0.3)	100 (40 ~ 150)	0.18 (0.1 ~ 0.3)
	43~48HRC	60 (40 ~ 120)	0.12 (0.05 ~ 0.2)	60 (40 ~ 120)	0.15 (0.05 ~ 0.2)

上記の数値は実切削速度における一般的な値を示したものです。加工環境に合わせて適宜調整して下さい。
The above cutting conditions are to be used as general guidelines. Adjustments may be necessary depending on actual cutting condition.

■切込深さを変えた時の条件変更の目安 Ratio of cutting condition by cutting depth to the above standard condition

切込深さ Depth of Cut ap (mm)	最大切込幅 Maximum width of Cut ae (mm)	切削速度係数 Ratio to adjust cutting speed VP	送り速度係数 Ratio to adjust feed rate fP
~ 0.2D	1D	0.8	0.5
0.2 ~ 0.3D	0.7D	0.8	0.6
0.4 ~ 0.5D	0.5D	0.9	0.7
0.6 ~ 0.7D	0.3D	0.9	0.8
0.8 ~ 1D	0.2D	1	0.9
1.1 ~ 1.5D	0.1D	1	1

例 Example
インサートサイズ SD*T09...、側面切削
φ50、ap = 50mm、S50C 切削時
Insert size SD*T09..., for cutting ø50, ap=50, side milling,
for carbon steel (S50C) machining
・150m/min(Vc) × 1.0(VP) = 150m/min
・0.2mm/t (fz) × 0.9(fP) = 0.18mm/t
・ae: 0.2 × φ50 = 10mm 以下
or less

Cutting Data

加工データ

■ 鋳物プレートの側面高能率加工 High productivity side milling of cast plate

使用工具 Tool	PSFL12R063M27-4-100(φ63×4刃) Flutes	他社高送りラジラスカッタ(φ50×3刃) Competitor's High Feed Radius Cutter Flutes
使用インサート(材種) Insert (grade)	SDKT120508SR-GR (XC1015)	超硬コーティングインサート Coated Carbide Insert
被削材 Work Material	FC300	
切削速度 Cutting Speed	120m/min(606min ⁻¹)	110m/min(700min ⁻¹)
送り速度 Feed	500mm/min(0.2mm/t)	2,800mm/min(0.133mm/t)
切込深さ Depth of Cut	ap=50mm ae=10mm	ap=2mm ae=10mm
切削油剤 Coolant	なし(エアブロー) Air Blow	
使用機械 Machine	門形マシニングセンタ(BT50) Double Column Machining Center	

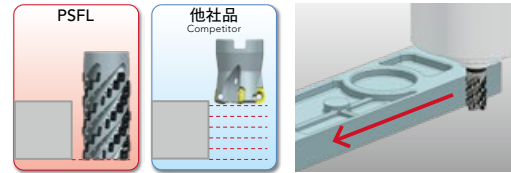
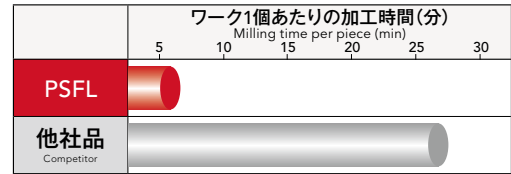

従来は不安定なワーククランプによるびびり振動を抑制するため、高送りラジラスカッタを使用し切込深さ(ap)を小さくして加工することを余儀なくされていた。不等リード配列・不等分割を採用したPSFLは、ap=50mmでもびびることなく加工することができた。

従来の高送りラジラスカッタでの加工に対し、大幅な加工時間の短縮を行うことができた。

Conventionally, in order to suppress chatter vibrations caused by an unstable work clamp, the high feed radius cutter is used with a smaller ap. With the PSFL's unequal spacing and variable lead design, stable milling with no chattering can be achieved even at ap=50mm.

■ チタン合金のトロコイド加工 Trochoid milling in titanium alloy

使用工具 Tool	PSFL09R050M22-4-50(φ50×4刃) Flutes	他社ラフinggカッタ(φ50×4刃) Competitor's Roughing Cutter Flutes
使用インサート(材種) Insert (grade)	SDKT09T308SR-GL (XC5040)	超硬コーティングインサート Coated Carbide Insert
被削材 Work Material	Ti-6Al-4V	
切削速度 Cutting Speed	60m/min(382min ⁻¹)	
送り速度 Feed	152mm/min(0.1mm/t)	
切込深さ Depth of Cut	ap=50mm ae=10mm	
切削油剤 Coolant	水溶性切削油剤(内部給油) Water-Soluble (Internal)	
使用機械 Machine	立形マシニングセンタ(BT50) Vertical Machining Center	

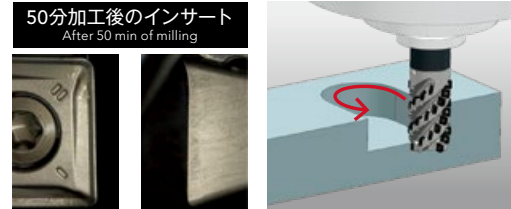
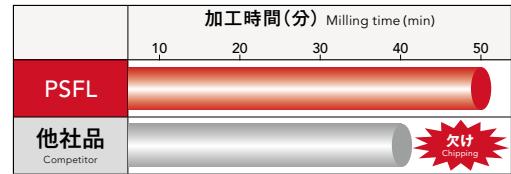

他社品は40分加工時点で刃先に欠け発生。

PSFLは50分加工しても刃先に欠けがなく、摩耗も軽微で継続可能な状態であった。

The competitor tool encountered chipping after milling for 40 minutes.

The PSFL, on the other hand, had no chipping, normal wear, and can continue to be used even after 50 minutes of machining.

■ FC250の長寿命加工 Long tool life in FC250

使用工具 Tool	PSFL12R063M27-4-100 (φ63×4刃) Flutes	他社Aラフinggカッタ Competitor's Roughing Cutter (φ63×4刃) Flutes	他社Bラフinggカッタ Competitor's Roughing Cutter (φ63×4刃) Flutes
使用インサート(材種) Insert (grade)	SDKT120508SR-GR (XC1015)	超硬コーティングインサート Coated Carbide Insert	超硬コーティングインサート Coated Carbide Insert
被削材 Work Material	FC250		
切削速度 Cutting Speed	100m/min(505min ⁻¹)		
送り速度 Feed	505mm/min(0.25mm/t)		
切込深さ Depth of Cut	ap=100mm ae=10mm		
切削油剤 Coolant	なし(エアブロー) Air Blow		
使用機械 Machine	横形マシニングセンタ(BT50) Horizontal Machining Center		

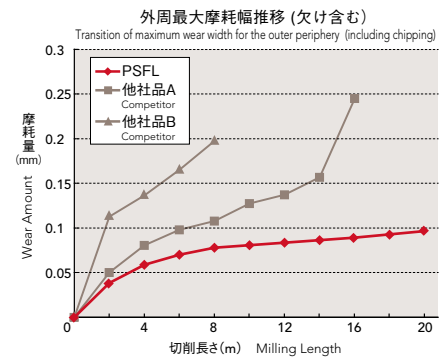

他社品は加工時の振動が大きく早期に欠けが発生したが、PSFLは防振効果により加工中の振動を抑えることで欠けることなく、長寿命加工を実現することができた。

Large chattering occurred during processing with the competitor tool, which led to early chipping. On the other hand, the PSFL's anti-vibration feature allows it to suppress chattering significantly, which led to minimized chipping and long tool life.

» Phoenix PSE

肩削りカッターシリーズ
Shoulder Cutter Series

Phoenix Shoulder End mill



■底部ノッチの効果 Bottom notch

- 底部ノッチによりランピングやヘリカル加工時に切りくずを2つに分断。
The bottom notch breaks chips into 2 pieces when processing ramping and helical milling.
- 切りくずの噛み込み・巻きつきの発生を抑制し、スムーズに加工可能。
Preventing chip jamming or wrapping and enabling smooth process.
- ノッチはPSE11 R1.6以下、PSE15 R2.5以下に適用。
The bottom notch is available in PSE11 R1.6 or less, and PSE15 R2.5 or less.

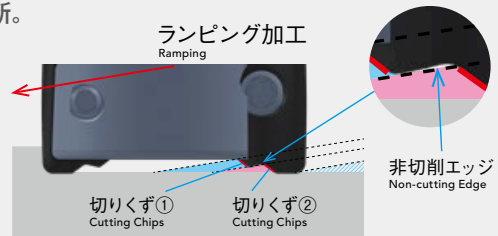

■豊富なバリエーション Broad Product Variations

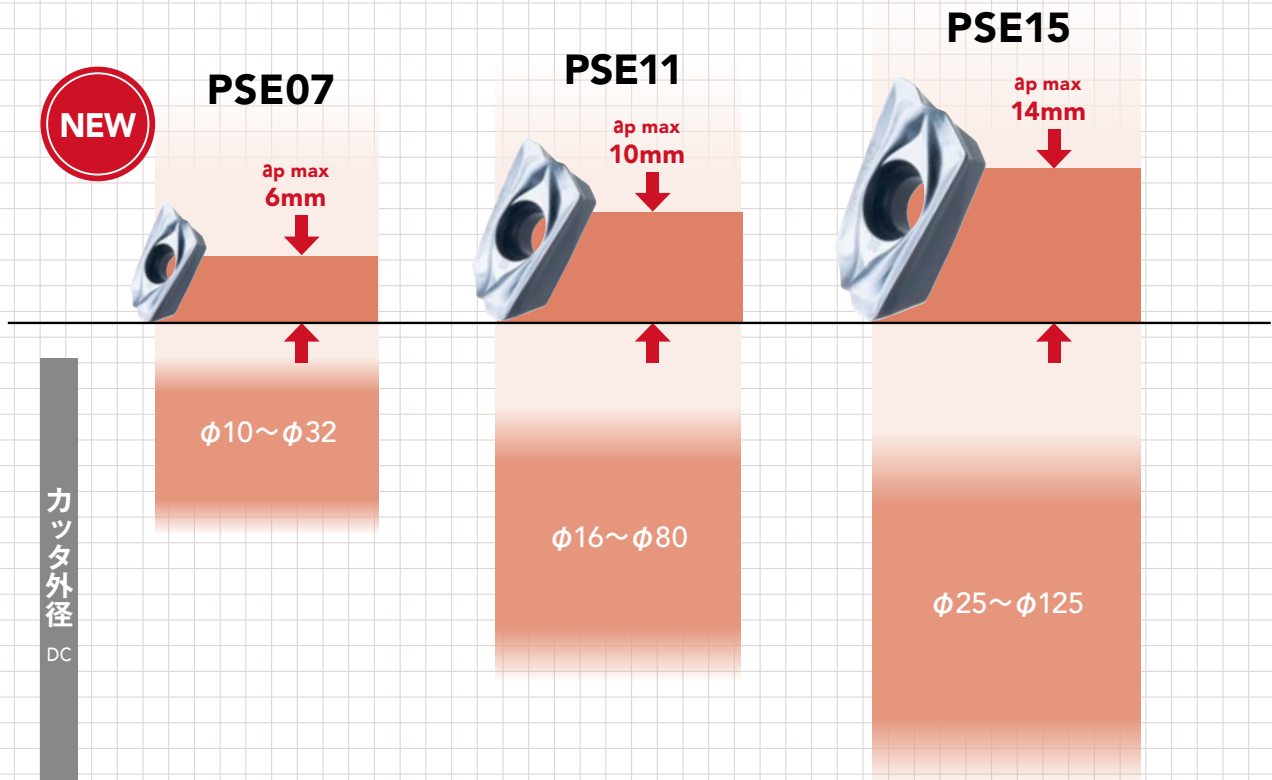

■小径～大径の豊富なバリエーションにより、幅広い加工領域に対応可能

Broad product variations and sizes to accommodate a wide range of machining needs

■荒取り加工における加工時間短縮を実現

Achieves processing time reduction in roughing

■低抵抗仕様により小型マシニングセンタでも高能率加工が可能

High efficiency processing is possible even on small machining centers with low resistance specifications

■高精度インサート High precision insert

—底面粗さ— Bottom roughness

工具 : PSE11R032SS32-5S (ZDKT11T304SR-GM XP3035) 被削材 : S50C
Tool Work Material
 切削条件 : $V_c=180\text{m/min}$ $f_z=0.1\text{mm/t}$ $a_p=0.1\text{mm}$ $a_e=25.6\text{mm}$
Cutting Conditions
 結果 : Ra: $0.5\mu\text{m}$ 以下 Rz: $4\mu\text{m}$ 以下とPSEの底面粗さの良好さが見られた。
Result : PSE showed an improvement at the bottom flat surface finish Rz $4\mu\text{m}$ and under.

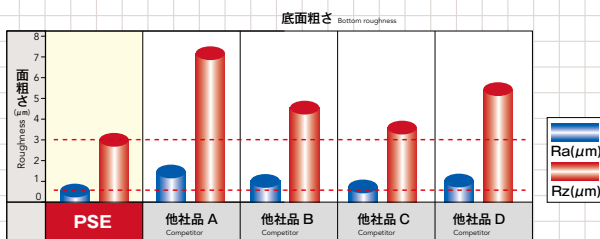

—側面加工段差— Side Milling Offset

工具 : PSE15R032SS32-3S (ZDKT150508SR-GM XP3035) 被削材 : S50C
Tool Work Material
 切削条件 : $V_c=180\text{m/min}$ $f_z=0.1\text{mm/t}$ $a_p=5\text{mm}$ $a_e=0.2\text{mm}$
Cutting Conditions
 結果 : 段差 $10\mu\text{m}$ (実績値)と、側面加工段差での性能が発揮された。
Result : Showed improvement at side step machining as (measured) step as $10\mu\text{m}$

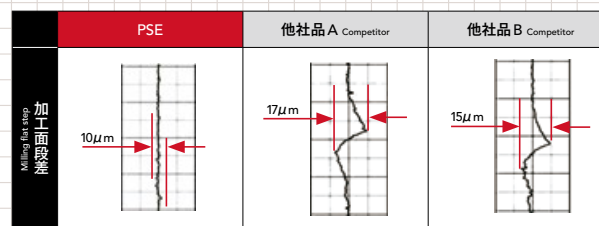

■豊富なインサートバリエーション Wide variety of inserts

ブレーカ Insert Breaker	NM	GL	SM	GM	GR	HR
用途 Application	アルミニウム合金 非鉄金属加工 Aluminum alloy & Non-ferrous metal	低抵抗加工 Low-resistance machining	超耐熱合金 難削材加工 Superalloy & Difficult-to-machine material	汎用加工 Multi-purpose machining	断続加工 長突出し加工 Interrupted machining & Long overhang machining	高硬度材加工 High-hardened material

■自動旋盤対応サイズをラインナップ(PSE07の一部サイズ) NEW

Lineup of sizes compatible with sliding head lathes (partial size listing of PSE07)

自動旋盤に適した形状 Tool geometry suitable for sliding head lathes

自動旋盤に使用可能なシャンク径・全長に設定しています

The shank diameter and overall length are configured so that they can be used for sliding head lathes

外径 DC	刃数 ZEFP	シャンク径 DCON	全長 LF
10	2	6	50
10	2	10	50
16	3	10	50
20	4	10	50
25	4	10	50



Phoenix

肩削りカッタ ストレートシャンクタイプ

Shoulder Cutter with Straight Shank

PSE SS

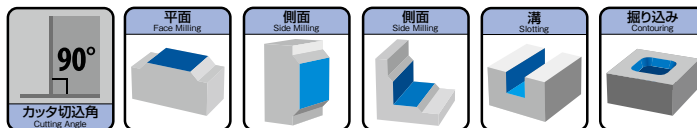

Specification

形状寸法表 Specification

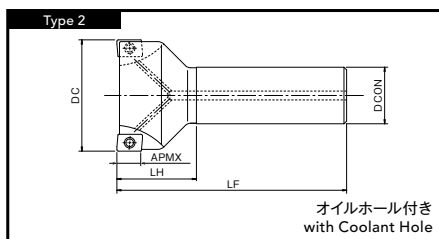
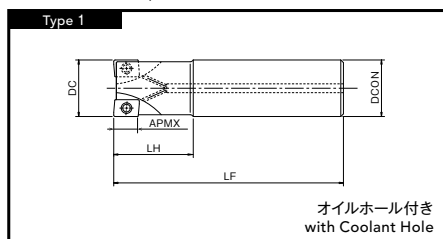

単位:mm Unit:mm

ツールNo. EDP No.	呼び Designation	外径 DC	刃数 ZEPF	シャンク径 DCON	全長 LF	首下長 LH	APMX	重量 (kg)	適用インサート Applicable Inserts	形状タイプ Type	標準価格 (Yen)
NEW 7803809	PSE07R010SS06-2S	★ 10	2	6	50	15	6	0.01	①	2	24,300
NEW 7803810	PSE07R010SS10-2S	10	2	10	50	12	6	0.025		1	24,300
NEW 7803811	PSE07R012SS12-3S	12	3	12	50	12	6	0.035		1	28,800
NEW 7803812	PSE07R016SS10-3S	★ 16	3	10	50	10	6	0.031		2	36,900
NEW 7803813	PSE07R016SS16-3S	16	3	16	90	25	6	0.123		1	37,000
NEW 7803814	PSE07R016SS16-4S	16	4	16	90	25	6	0.122		1	40,100
NEW 7803815	PSE07R017SS16-3L	★ 17	3	16	150	25	6	0.212		2	38,500
NEW 7803816	PSE07R020SS10-4S	★ 20	4	10	50	12	6	0.036		2	41,100
NEW 7803817	PSE07R020SS20-4S	20	4	20	100	30	6	0.213		1	41,700
NEW 7803818	PSE07R021SS20-4L	★ 21	4	20	160	30	6	0.354		2	43,600
NEW 7803819	PSE07R025SS10-4S	★ 25	4	10	50	12	6	0.049		2	41,500
NEW 7803820	PSE07R025SS25-5S	25	5	25	120	35	6	0.416		1	49,300
NEW 7803821	PSE07R026SS25-5L	★ 26	5	25	170	35	6	0.604		2	53,800

★ 刃太タイプ
Reduced Shank Type

NEXT

青字 = 自動旋盤対応サイズ
Blue = size compatible with sliding head lathes

自動旋盤対応サイズ Sizes for sliding head lathes

自動旋盤に使用可能な
シャンク径・全長に設定しています

The shank diameter and overall length are configured so that they can be used for sliding head lathes



★ PSE 刃太タイプ Reduced Shank Type

・刃太タイプは、シャンク径よりも工具外径の方が大きいため、金型部品などの深い立ち壁加工やポケット加工に最適です

・The outer diameter of the reduced shank type is larger than the shank diameter, making it highly effective in the processing of die and mold applications that require vertical wall milling or pocketing.

例
Example



FROM

単位:mm Unit:mm

ツールNo. EDP No.	呼び Designation	外径 DC	刃数 ZEPF	シャンク径 DCON	全長 LF	首下長 LH	APMX	重量 (kg)	適用インサート Applicable Inserts	形状タイプ Type	標準価格 (¥/en)
7801100	PSE11R016SS16-2S	16	2	16	90	25	10	0.12	②	1	38,600
7801121	PSE11R016SS16-2L	16	2	16	150	50	10	0.21		1	46,600
7801139	PSE11R017SS16-2L	★ 17	2	16	150	25	10	0.22		2	46,600
7801116	PSE11R018SS16-2S	★ 18	2	16	90	25	10	0.13		2	44,700
7801122	PSE11R018SS16-2L	★ 18	2	16	150	25	10	0.21		2	45,400
7801101	PSE11R020SS20-2S	20	2	20	100	30	10	0.21		1	45,700
7801115	PSE11R020SS20-3S	20	3	20	100	30	10	0.21		1	45,700
7801123	PSE11R020SS20-3L	20	3	20	160	60	10	0.34		1	52,400
7801140	PSE11R021SS20-3L	★ 21	3	20	160	30	10	0.35		2	52,400
7801117	PSE11R022SS20-3S	★ 22	3	20	110	30	10	0.24		2	53,200
7801124	PSE11R022SS20-3L	★ 22	3	20	160	30	10	0.35		2	52,400
7801102	PSE11R025SS25-3S	25	3	25	120	35	10	0.4		1	47,000
7801125	PSE11R025SS25-3L	25	3	25	170	70	10	0.57		1	56,200
7801104	PSE11R025SS25-4S	25	4	25	120	35	10	0.4		1	53,800
7801141	PSE11R026SS25-3L	★ 26	3	25	170	35	10	0.59		2	56,200
7801126	PSE11R028SS25-3L	★ 28	3	25	170	35	10	0.59		2	56,200
7801118	PSE11R028SS25-4S	★ 28	4	25	120	35	10	0.42		2	62,000
7801127	PSE11R030SS32-3L	30	3	32	190	90	10	1.01		1	59,600
7801119	PSE11R030SS32-4S	30	4	32	130	45	10	0.69		1	62,300
7801103	PSE11R032SS32-3S	32	3	32	130	45	10	0.73		1	54,500
7801128	PSE11R032SS32-3L	32	3	32	190	90	10	1.08	1	59,600	
7801105	PSE11R032SS32-5S	32	5	32	125	40	10	0.7	1	60,400	
7801142	PSE11R033SS32-3L	★ 33	3	32	190	35	10	1.09	2	63,100	
7801129	PSE11R035SS32-3L	★ 35	3	32	190	35	10	1.11	2	63,100	
7801120	PSE11R035SS32-5S	★ 35	5	32	130	35	10	0.75	2	70,300	

★ 刃太タイプ
Reduced Shank Type

NEXT

Phoenix

肩削りカッタ ストレートシャンクタイプ

Shoulder Cutter with Straight Shank

PSE SS

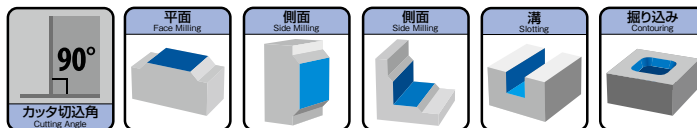

Specification

形状寸法表 Specification

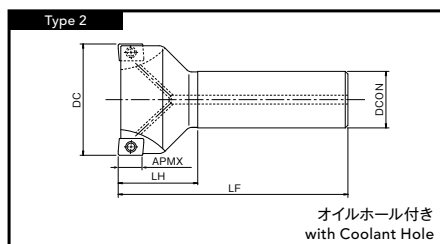
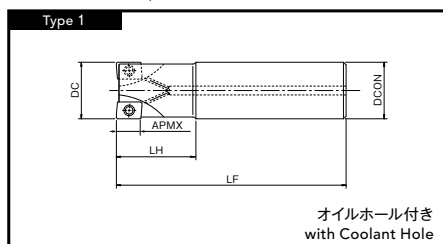

単位:mm Unit:mm

FROM

ツールNo. EDP No.	呼び Designation	外径 DC	刃数 ZEPF	シャンク径 DCON	全長 LF	首下長 LH	APMX	重量 (kg)	適用インサート Applicable Inserts	形状タイプ Type	標準価格 (Yen)
7801106	PSE15R025SS25-2S	25	2	25	120	35	14	0.38	③	1	40,100
7801133	PSE15R025SS25-2L	25	2	25	170	70	14	0.55		1	53,800
7801143	PSE15R026SS25-2L	★ 26	2	25	170	35	14	0.57		2	53,800
7801130	PSE15R028SS25-2S	★ 28	2	25	120	35	14	0.4		2	46,300
7801134	PSE15R028SS25-2L	★ 28	2	25	170	35	14	0.58		2	53,800
7801131	PSE15R030SS32-3S	30	3	32	130	45	14	0.67		1	57,300
7801135	PSE15R030SS32-3L	30	3	32	190	90	14	0.98		1	56,200
7801107	PSE15R032SS32-2S	32	2	32	130	45	14	0.7		1	44,700
7801111	PSE15R032SS32-3S	32	3	32	130	45	14	0.69		1	49,700
7801136	PSE15R032SS32-3L	32	3	32	190	90	14	1.04		1	56,200
7801144	PSE15R033SS32-3L	★ 33	3	32	190	45	14	1.07		2	59,600
7801132	PSE15R035SS32-3S	★ 35	3	32	130	35	14	0.72		2	59,600
7801137	PSE15R035SS32-3L	★ 35	3	32	190	45	14	1.08		2	59,600
7801108	PSE15R040SS32-3S	40	3	32	140	50	14	0.82		2	52,200
7801138	PSE15R040SS32-3L	40	3	32	190	45	14	1.11		2	64,100
7801112	PSE15R040SS32-4S	40	4	32	140	50	14	0.83		2	62,000
7801109	PSE15R050SS32-3S	50	3	32	130	45	14	0.88		2	62,000
7801113	PSE15R050SS32-5S	50	5	32	130	45	14	0.87		2	87,700
7801110	PSE15R063SS32-4S	63	4	32	130	45	14	1.04		2	80,500
7801114	PSE15R063SS32-6S	63	6	32	130	45	14	1.04		2	101,000

★刃太タイプ 詳細はp.106をご覧ください。
Reduced Shank Type See p.106 for details.

Phoenix

肩削りカッタ ボアタイプ
Shoulder Cutter with Bore Type

PSE BORE

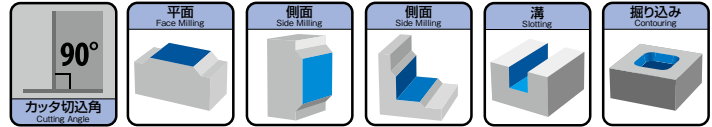

Specification

■形状寸法表 Specification

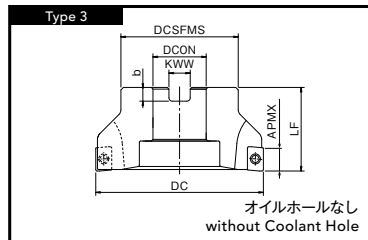
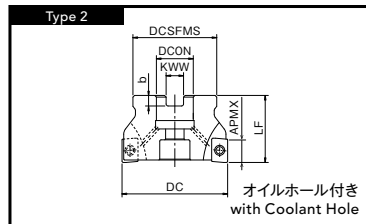
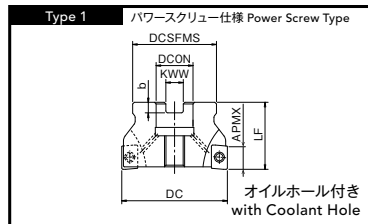

単位:mm Unit:mm

ツールNo. EDP No.	呼び Designation	外径 DC	刃数 ZEPF	カッタ 高さ LF	ボス径 DCSFMS	穴径 DCON	端面キー溝 Key Slot		APMX	重量 (kg)	適用インサート Applicable Inserts	形状 タイプ Type	標準価格 (Yen)
							幅 KWW	深さ b					
7801000	PSE11R040M16-4	40	4	40	38	16	8.4	5.6	10	0.21	②	1	54,600
7801004	PSE11R040M16-6	40	6	40	38	16	8.4	5.6	10	0.22		1	66,300
7801001	PSE11R050M22-5	50	5	40	45	22	10.4	6.3	10	0.3		1	66,400
7801005	PSE11R050M22-7	50	7	40	45	22	10.4	6.3	10	0.33		1	77,000
7801002	PSE11R063M22-6	63	6	40	50	22	10.4	6.3	10	0.5		2	76,000
7801006	PSE11R063M22-8	63	8	40	50	22	10.4	6.3	10	1.07		2	84,500
7801020	PSE11R080M25.4-7	80	7	50	60	25.4	9.5	6	10	1.05		2	86,400
7801003	PSE11R080M27-7	80	7	50	60	27	12.4	7	10	1.04		2	86,400
7801021	PSE11R080M25.4-10	80	10	50	60	25.4	9.5	6	10	1.04		2	101,000
7801007	PSE11R080M27-10	80	10	50	60	27	12.4	7	10	1.03		2	101,000
7801008	PSE15R040M16-3	40	3	40	38	16	8.4	5.6	14	0.19	③	1	50,200
7801014	PSE15R040M16-4	40	4	40	38	16	8.4	5.6	14	0.19		1	56,200
7801009	PSE15R050M22-3	50	3	40	45	22	10.4	6.3	14	0.3		1	58,000
7801015	PSE15R050M22-5	50	5	40	45	22	10.4	6.3	14	0.28		1	68,400
7801010	PSE15R063M22-4	63	4	40	50	22	10.4	6.3	14	0.47		2	62,900
7801016	PSE15R063M22-6	63	6	40	50	22	10.4	6.3	14	0.46		2	78,200
7801022	PSE15R080M25.4-5	80	5	50	60	25.4	9.5	6	14	1		2	74,900
7801011	PSE15R080M27-5	80	5	50	60	27	12.4	7	14	0.99		2	74,900
7801025	PSE15R080M25.4-8	80	8	50	60	25.4	9.5	6	14	1.01		2	93,700
7801017	PSE15R080M27-8	80	8	50	60	27	12.4	7	14	1		2	93,700
7801023	PSE15R100M31.7-7	100	7	50	70	31.75	12.7	8	14	1.45	3	96,600	
7801012	PSE15R100M32-7	100	7	50	70	32	14.4	8	14	1.58	2	96,600	
7801026	PSE15R100M31.7-10	100	10	50	70	31.75	12.7	8	14	1.5	3	109,000	
7801018	PSE15R100M32-10	100	10	50	70	32	14.4	8	14	1.63	2	109,000	
7801024	PSE15R125M38.1-8	125	8	63	90	38.1	15.9	10	14	3.13	3	115,000	
7801027	PSE15R125M38.1-11	125	11	63	90	38.1	15.9	10	14	3.15	3	126,000	

在庫区分は全てC(標準在庫品)となります。 Stock are categorized as C (Standard stock item).

Specification

■形状寸法表 Specification

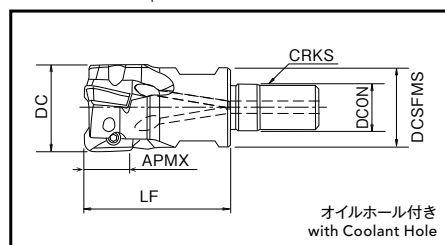

PSE ねじ込みタイプ Screw Fit Type

単位:mm Unit:mm

ツールNo. EDP No.	呼び Designation	外径 DC	刃数 ZEPF	取付け径 DCON	ねじサイズ CRKS	スパナサイズ Spanner Size	全長 LF	端面径 DCSFMS	APMX	重量 (kg)	適用インサート Applicable Inserts	適用シャンク ホルダタイプ Applicable Shank	標準価格 (Yen)	
NEW 7803822	PSE07R010SF6-2	10	2	6.5	M 6	7	26	9	6	0.011	①	①	29,400	
NEW 7803823	PSE07R012SF6-3	12	3	6.5	M 6	7	26	11	6	0.01		②	36,400	
NEW 7803824	PSE07R016SF8-4	16	4	8.5	M 8	10	27	15	6	0.032		③	40,100	
NEW 7803825	PSE07R020SF10-4	20	4	10.5	M10	14	33	18	6	0.063		④	44,900	
NEW 7803826	PSE07R025SF12-5	25	5	12.5	M12	17	35	23	6	0.111		⑤	52,500	
NEW 7803827	PSE07R032SF16-6	32	6	17	M16	22	35	28	6	0.176		⑥	57,700	
7801600	PSE11R016SF8-2	16	2	8.5	M 8	10	27	14.5	10	0.03	②	③	46,600	
7801612	PSE11R017SF8-2	★17	2	8.5	M 8	10	27	14.5	10	0.03		④	46,600	
7801613	PSE11R018SF8-2	★18	2	8.5	M 8	10	27	14.5	10	0.03		⑤	46,600	
7801601	PSE11R020SF10-3	20	3	10.5	M10	14	33	18	10	0.06		⑥	63,100	
7801614	PSE11R021SF10-3	★21	3	10.5	M10	14	33	18	10	0.06		⑦	63,100	
7801615	PSE11R022SF10-3	★22	3	10.5	M10	14	33	18	10	0.06		⑧	63,100	
7801602	PSE11R025SF12-4	25	4	12.5	M12	17	35	23	10	0.1		⑨	77,000	
7801616	PSE11R026SF12-3	★26	3	12.5	M12	17	35	23	10	0.1		⑩	77,000	
7801603	PSE11R028SF12-4	★28	4	12.5	M12	17	35	23	10	0.11		⑪	77,000	
7801604	PSE11R032SF16-5	32	5	17	M16	22	40	28	10	0.19		⑫	94,400	
7801617	PSE11R033SF16-3	★33	3	17	M16	22	40	28	10	0.2		⑬	94,400	
7801605	PSE11R035SF16-5	★35	5	17	M16	22	40	28	10	0.2		⑭	94,400	
7801606	PSE11R040SF16-6	40	6	17	M16	22	40	28	10	0.22		⑮	103,000	
7801607	PSE15R025SF12-2	25	2	12.5	M12	17	35	23	14	0.09		③	⑯	56,100
7801618	PSE15R026SF12-2	★26	2	12.5	M12	17	35	23	14	0.1			⑰	56,100
7801608	PSE15R028SF12-2	★28	2	12.5	M12	17	35	23	14	0.1			⑱	56,100
7801609	PSE15R032SF16-3	32	3	17	M16	22	40	28	14	0.17			⑲	77,000
7801619	PSE15R033SF16-3	★33	3	17	M16	22	40	28	14	0.18			⑳	77,000
7801610	PSE15R035SF16-3	★35	3	17	M16	22	40	28	14	0.18	㉑		77,000	
7801611	PSE15R040SF16-4	40	4	17	M16	22	40	28	14	0.2	㉒		88,200	

シャンクホルダについてはp.242～p.244をご覧ください。
See p.242-p.244 for shank holders.

★刃太タイプ 詳細はp.106をご覧ください。
Reduced Shank Type See p.106 for details.

Accessories

■部品 Accessories

	ツールNo. EDP No.	呼び Designation	適用インサート Applicable Inserts		適用ボディ Applicable Body
 クランプねじ Clamping Screw	7808098	FS18634P (Torx 6IP)	①	ZDKT07...	PSE SS/SF φ10~12
	7808099	FS18637P (Torx 6IP)			PSE SS φ16~26 PSE SF φ16~32
	7808107	FS25656P (Torx 8IP)	②	ZD*T11...	PSE SS/SF φ16~40
	7808109	FS25673P (Torx 8IP)			PSE BORE φ40~80
	7808115	FS35686P (Torx 15IP)	③	ZDKT15...	PSE SS/SF φ25~63 PSE BORE φ40~125
 パワースクリュー Power Screw	7808150	PS0830 (M8×30)	②	ZD*T11...	PSE BORE φ40
			③	ZDKT15...	
	7808151	PS1031 (M10×31)	②	ZD*T11...	PSE BORE φ50
			③	ZDKT15...	

	ツールNo. EDP No.	呼び Designation	適用インサート Applicable Inserts		適用ボディ Applicable Body	標準価格 (Yen)
 レンチ Wrench	7808223	6IP-D (Torx 6IP)	①	ZDKT07...	PSE SS φ10~26 PSE SF φ10~32	1,600
	7808225	8IP-D (Torx 8IP)	②	ZD*T11...	PSE SS/SF φ16~40 PSE BORE φ40~80	1,560
	7808228	15IP-D (Torx 15IP)	③	ZDKT15...	PSE SS/SF φ25~63 PSE BORE φ40~125	1,820

レンチは別途ご購入下さい。 The wrenches are sold separately from the cutters.

Phoenix

肩削りカッタシリーズ

Shoulder Cutter Series

PSEインサート

Inserts

Inserts

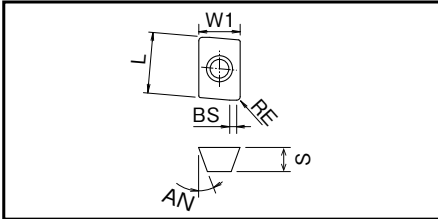

■適用インサート Inserts

呼び Designation	切れ刃数 No. of Cutting Edges	インサート寸法 Insert Size					超硬 Uncoated	CK010
		L×W1	厚さ S	逃げ角 AN	RE	さらい刃 (副切れ刃) BS		
NEW ZDKT070302FR-NM	2	8.2×4	2.54	15°	0.2	1.1	7811112	
NEW ZDKT070304FR-NM	2	8.2×4	2.54	15°	0.4	0.9	7811113	
NEW ZDKT070304SR-GL	2	8.2×4	2.54	15°	0.4	0.9		
NEW ZDKT070308SR-GL	2	8.2×4	2.54	15°	0.8	0.5		
NEW ZDKT070302SR-GM	2	8.2×4	2.54	15°	0.2	1.1		
NEW ZDKT070304SR-GM	2	8.2×4	2.54	15°	0.4	0.9		
NEW ZDKT070308SR-GM	2	8.2×4	2.54	15°	0.8	0.5		

単位:mm Unit:mm

コーティング材種 Grade of Coated Materials											標準価格 (Yen)
	XC3020	XP3025	XC3030	XP3035	XP2025	XP2040	XC1015	XC5035	XC5040	XP6015	
											1,210
											1,210
			7825127	7814123	7826121	7813117					1,210
			7825129	7814125	7826122	7813119					1,210
						7813116					1,210
			7825128	7814124		7813118	7812114				1,210
			7825130	7814126		7813120	7812115				1,210

NEXT

在庫区分は全てC(標準在庫品)となります。 Stock are categorized as C (Standard stock item).

Inserts

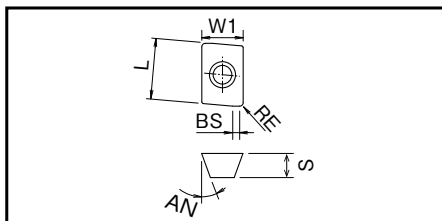

FROM

■適用インサート Inserts

呼び Designation	切れ刃数 No. of Cutting Edges	インサート寸法 Insert Size					超硬 Uncoated	CK010
		L×W1	厚さ S	逃げ角 AN	RE	ざらい刃 (副切れ刃) BS		
ZDKT11T302FR-NM	2	11×6.8	3.8	15°	0.2	2.0	7811048	
ZDKT11T304FR-NM	2	11×6.8	3.8	15°	0.4	1.8	7811049	
ZDKT11T308FR-NM	2	11×6.8	3.8	15°	0.8	1.4	7811023	
ZDHT11T302FR-NM	2	11×6.8	3.5	15°	0.2	2.0	7811010	
ZDHT11T304FR-NM	2	11×6.8	3.5	15°	0.4	1.8	7811024	
ZDHT11T308FR-NM	2	11×6.8	3.5	15°	0.8	1.4	7811014	
ZDHT11T312FR-NM	2	11×6.8	3.5	15°	1.2	1.4	7811015	
ZDHT11T316FR-NM	2	11×6.8	3.5	15°	1.6	1.4	7811017	
ZDHT11T320FR-NM	2	11×6.8	3.5	15°	2.0	1.4	7811018	
ZDHT11T325FR-NM	2	11×6.8	3.5	15°	2.5	1.4	7811019	
ZDHT11T332FR-NM	2	11×6.8	3.5	15°	3.2	0.8	7811020	
ZDHT11T340FR-NM	2	11×6.8	3.5	15°	4.0	—	7811021	
ZDHT11T350FR-NM	2	11×6.8	3.5	15°	5.0	—	7811022	
ZDKT11T304SR-GL	2	11×6.8	3.8	15°	0.4	1.8		
ZDKT11T308SR-GL	2	11×6.8	3.8	15°	0.8	1.4		
ZDKT11T312SR-GL	2	11×6.8	3.8	15°	1.2	1.0		
ZDKT11T320SR-GL	2	11×6.8	3.8	15°	2.0	2.1		
② ZDKT11T332SR-GL	2	11×6.8	3.8	15°	3.2	1.5		
ZDKT11T304SR-GM	2	11×6.8	3.8	15°	0.4	1.8		
ZDKT11T308SR-GM	2	11×6.8	3.8	15°	0.8	1.4		
ZDKT11T312SR-GM	2	11×6.8	3.8	15°	1.2	1.0		
ZDKT11T320SR-GM	2	11×6.8	3.8	15°	2.0	2.1		
ZDKT11T325SR-GM	2	11×6.8	3.8	15°	2.5	1.6		
ZDKT11T330SR-GM	2	11×6.8	3.8	15°	3.0	1.5		
ZDKT11T340SR-GM	2	11×6.8	3.8	15°	4.0	—		
ZDKT11T308SR-GR	2	11×6.8	3.8	15°	0.8	1.4		
ZDKT11T308SR-HR	2	11×6.8	3.8	15°	0.8	1.4		
ZDKT11T304ER-SM	2	11×6.8	3.8	15°	0.4	1.8		
ZDKT11T308ER-SM	2	11×6.8	3.8	15°	0.8	1.4		
ZDKT11T312ER-SM	2	11×6.8	3.8	15°	1.2	1.1		
ZDKT11T316ER-SM	2	11×6.8	3.8	15°	1.6	0.8		
ZDKT11T320ER-SM	2	11×6.8	3.8	15°	2.0	0.3		
ZDKT11T325ER-SM	2	11×6.8	3.8	15°	2.5	—		
ZDKT11T332ER-SM	2	11×6.8	3.8	15°	3.2	—		
ZDKT11T340ER-SM	2	11×6.8	3.8	15°	4.0	—		

Phoenix

肩削りカッタシリーズ

Shoulder Cutter Series

PSEインサート

Inserts

Inserts

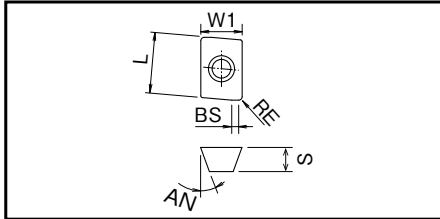

FROM

■適用インサート Inserts

呼び Designation	切れ刃数 No. of Cutting Edges	インサート寸法 Insert Size					超硬 Uncoated	CK010
		L×W1	厚さ S	逃げ角 AN	RE	ざらい刃 (副切れ刃) BS		
③	ZDKT150508FR-NM	2	15×9.3	5.56	15°	0.8	1.6	7811046
	ZDKT150508SR-GL	2	15×9.3	5.56	15°	0.8	1.6	
	ZDKT150508SR-GM	2	15×9.3	5.56	15°	0.8	1.6	
	ZDKT150512SR-GM	2	15×9.3	5.56	15°	1.2	1.2	
	ZDKT150516SR-GM	2	15×9.3	5.56	15°	1.6	0.8	
	ZDKT150520SR-GM	2	15×9.3	5.56	15°	2.0	2.1	
	ZDKT150530SR-GM	2	15×9.3	5.56	15°	3.0	1.9	
	ZDKT150540SR-GM	2	15×9.3	5.56	15°	4.0	1.1	
	ZDKT150550SR-GM	2	15×9.3	5.56	15°	5.0	0.7	
	ZDKT150508SR-GR	2	15×9.3	5.56	15°	0.8	1.6	
	ZDKT150508SR-HR	2	15×9.3	5.56	15°	0.8	1.6	
	ZDKT150508ER-SM	2	15×9.3	5.56	15°	0.8	1.6	

・コーナR=R2以上のインサートを使用する場合、カッタボディのコーナ部を修正する必要があります。
修正が必要な場合は受注品対応となりますのでご相談下さい。

・ When using an insert with a corner radius of R2 or greater, the corner of the cutter body must be modified.
Please contact us for modification service if necessary.



単位:mm Unit:mm

コーティング材種 Grade of Coated Materials											標準価格 (Yen)
	XC3020	XP3025	XC3030	XP3035	XP2025	XP2040	XC1015	XC5035	XC5040	XP6015	
											2,380
	7827057	7828057	7825057	7814057	7826057	7813057					2,170
	7827028	7828028	7825029	7814029	7826029	7813028	7812029				2,170
				7814077		7813077					2,170
				7814078		7813078					2,170
				7814079		7813079					2,170
				7814080		7813080					2,170
				7814081		7813081					2,170
				7814082		7813082					2,170
	7827058	7828058	7825058	7814058		7813058	7812058				2,170
										7824036	2,170
								7815056	7816056		4,170

Phoenix

肩削りカッタシリーズ

Shoulder Cutter Series

PSE

■被削材別推奨材質

Recommended Materials by Insert Type

◎第一推奨材質 Best
○第二推奨材質 Good

インサート材種 Insert Grades	ブレーカ Insert Breaker	切削油剤 Coolant	P	M	K	N	S	H
CK010	NM	有 Wet				◎		
XC3020	GL GM GR	無 Dry	◎		○			
XP3025	GL GM GR	有 Wet	◎		○			
XC3030	GL GM GR	無 Dry	◎		○			
XP3035	GL GM GR	無 Dry	◎	○	○			
		有 Wet						

インサート材種 Insert Grades	ブレーカ Insert Breaker	切削油剤 Coolant	P	M	K	N	S	H
XP2025	GL GM	有 Wet	○	◎			○	
XP2040	GL GM GR	無 Dry	○	○				○
		有 Wet	○	◎			○	
XC1015	GM GR	無 Dry			◎			
XC5035	SM	無 Dry		◎				
		有 Wet		○			○	
XC5040	SM	有 Wet		○			◎	
XP6015	HR	無 Dry	○		○			◎

NM:アルミニウム合金用 GL:軽切削用 GM:中切削用 GR:重切削用 HR:高硬度鋼用 SM:耐熱合金用

NM:Aluminum Alloy GL:Light Cutting GM:Middle Cutting GR:Heavy Cutting HR:High Hardened Steel SM:Heat Resistance Alloy

■切削条件基準表 Cutting Conditions

被削材 Work Material	引張強さ 硬さ Tensile Strength Hardness	インサートサイズ Insert Size												
		ZDKT07...				ZD*T11...				ZDKT15...				
		切削深さap:6mm 切削幅ae:0.15D		切削深さap:0.8mm 切削幅ae:1.0D		切削深さap:10mm 切削幅ae:0.2D		切削深さap:3mm 切削幅ae:1.0D		切削深さap:14mm 切削幅ae:0.2D		切削深さap:5mm 切削幅ae:1.0D		
		切削速度 Vc (m/min) Cutting Speed	一刃当たりの 送り量 fz (mm/t) Feed per Tooth	切削速度 Vc (m/min) Cutting Speed	一刃当たりの 送り量 fz (mm/t) Feed per Tooth	切削速度 Vc (m/min) Cutting Speed	一刃当たりの 送り量 fz (mm/t) Feed per Tooth	切削速度 Vc (m/min) Cutting Speed	一刃当たりの 送り量 fz (mm/t) Feed per Tooth	切削速度 Vc (m/min) Cutting Speed	一刃当たりの 送り量 fz (mm/t) Feed per Tooth	切削速度 Vc (m/min) Cutting Speed	一刃当たりの 送り量 fz (mm/t) Feed per Tooth	
P 軟鋼、低炭素鋼 Mild Steel, Carbon Steel (S5400, S10C)	~180HB	180 (100~250)	0.1 (0.04~0.12)	180 (100~250)	0.08 (0.04~0.1)	180 (100~250)	0.25 (0.2~0.5)	180 (100~250)	0.12 (0.05~0.2)	180 (100~250)	0.3 (0.2~0.6)	180 (100~250)	0.15 (0.05~0.25)	
	炭素鋼、合金鋼 Carbon Steel, Alloy Steel (S50C, SCM440)	~280HB	180 (100~250)	0.07 (0.04~0.1)	180 (100~250)	0.08 (0.04~0.1)	180 (100~250)	0.2 (0.15~0.4)	180 (100~250)	0.11 (0.05~0.2)	180 (100~250)	0.25 (0.15~0.5)	180 (100~250)	0.12 (0.05~0.2)
	ダイス鋼 Die Steel (SKD11, SKD61)	~280HB	140 (80~180)	0.07 (0.04~0.1)	140 (80~180)	0.07 (0.04~0.1)	150 (80~200)	0.2 (0.15~0.4)	150 (80~200)	0.1 (0.05~0.18)	150 (80~200)	0.25 (0.15~0.5)	150 (80~200)	0.12 (0.05~0.2)
M ステンレス鋼(乾式) Stainless Steel (Dry) (SUS304, SUS420)	~250HB	140 (80~180)	0.06 (0.04~0.08)	140 (80~180)	0.05 (0.04~0.08)	150 (80~200)	0.18 (0.15~0.4)	150 (80~200)	0.1 (0.05~0.18)	150 (80~200)	0.2 (0.15~0.45)	150 (80~200)	0.12 (0.05~0.2)	
	ステンレス鋼(湿式) Stainless Steel (Wet) (SUS304, SUS420)	~250HB	80 (60~100)	0.06 (0.04~0.08)	80 (60~100)	0.05 (0.04~0.08)	80 (60~120)	0.18 (0.15~0.4)	80 (60~120)	0.1 (0.05~0.18)	80 (60~120)	0.2 (0.15~0.45)	80 (60~120)	0.12 (0.05~0.2)
K 鋳鉄 Cast Iron (FC250)	~350N/mm ²	180 (100~300)	0.1 (0.04~0.12)	180 (100~300)	0.1 (0.04~0.12)	180 (100~300)	0.25 (0.15~0.5)	180 (100~300)	0.12 (0.05~0.2)	180 (100~300)	0.3 (0.2~0.6)	180 (100~300)	0.15 (0.05~0.25)	
	ダクタイル鋳鉄 Ductile Cast Iron (FCD400)	~800N/mm ²	180 (100~300)	0.07 (0.04~0.1)	180 (100~300)	0.06 (0.04~0.08)	180 (100~250)	0.15 (0.1~0.4)	180 (100~250)	0.12 (0.05~0.2)	180 (100~250)	0.2 (0.15~0.5)	180 (100~250)	0.15 (0.05~0.25)
N アルミニウム合金 Aluminum Alloy	~13%Si	300 (200~1,500)	0.15 (0.04~0.3)	300 (200~1,500)	0.12 (0.04~0.2)	300 (200~1,500)	0.3 (0.2~0.5)	300 (200~1,500)	0.15 (0.1~0.25)	300 (200~1,500)	0.35 (0.2~0.6)	300 (200~1,500)	0.18 (0.1~0.3)	
S 超耐熱合金(湿式) Superalloy (Wet) (Inconel 718)	-	35 (25~60)	0.07 (0.04~0.1)	35 (25~60)	0.06 (0.04~0.08)	35 (25~60)	0.15 (0.1~0.3)	35 (25~60)	0.1 (0.05~0.15)	35 (25~60)	0.2 (0.1~0.3)	35 (25~60)	0.12 (0.05~0.15)	
	チタン合金(湿式) Titanium Alloy (Wet) (Ti-6Al-4V)	-	45 (35~70)	0.07 (0.04~0.1)	45 (35~70)	0.07 (0.04~0.1)	40 (30~120)	0.18 (0.1~0.35)	40 (30~120)	0.1 (0.08~0.25)	40 (30~120)	0.22 (0.1~0.35)	40 (30~120)	0.12 (0.08~0.25)
H プリハードン鋼 Pre-hardened Steel (NAK80)	40~43HRC	100 (40~150)	0.08 (0.04~0.12)	100 (40~150)	0.06 (0.04~0.08)	100 (40~150)	0.18 (0.1~0.3)	90 (40~150)	0.1 (0.08~0.2)	100 (40~150)	0.22 (0.1~0.35)	90 (40~150)	0.12 (0.08~0.25)	
	ダイカスト用鋼 Steel for Die Casting (DAC-MAGIC, DH31)	43~48HRC	80 (40~100)	0.06 (0.03~0.08)	80 (40~100)	0.06 (0.03~0.08)	80 (40~120)	0.12 (0.08~0.2)	70 (40~120)	0.08 (0.06~0.15)	80 (40~120)	0.15 (0.08~0.25)	70 (40~120)	0.1 (0.06~0.2)
	調質鋼 Hardened Steel (SKD11)	50~55HRC	60 (40~70)	0.06 (0.03~0.08)	60 (40~70)	0.06 (0.03~0.08)	60 (40~90)	0.1 (0.05~0.2)	50 (40~90)	0.06 (0.05~0.1)	60 (40~90)	0.12 (0.05~0.2)	50 (40~90)	0.08 (0.05~0.12)

- ・溝加工はコースピッチを推奨します。 ・上記条件表はショートシャンクタイプにおける推奨値となります。
- ・上記の数値は実切削速度における一般的な値を示したものです。加工環境に合わせて適宜調整して下さい。
- ・ Course pitch is recommended for Slotting. ・ Above recommended speed is for Short Shank Type.
- ・ The above cutting conditions are to be used as general guidelines. Adjustments may be necessary depending on actual cutting condition.

■切削条件基準表 Cutting Conditions

自動旋盤用 For sliding head lathes

	被削材 Work Material	引張強さ・硬さ Tensile Strength · Hardness	インサートサイズ Insert Size			
			ZDKT07...			
			切削深さap:2mm 切 削 幅 ae:0.7D		切削深さap:0.5mm 切 削 幅 ae:1.0D	
			切削速度 Vc (m/min) Cutting Speed	一刃当たりの 送り量 fz (mm/t) Feed per Tooth	切削速度 Vc (m/min) Cutting Speed	一刃当たりの 送り量 fz (mm/t) Feed per Tooth
P	軟鋼、低炭素鋼 Mild Steel, Carbon Steel (SS400, S10C)	~180HB	60 (40 ~ 80)	0.07 (0.03 ~ 0.1)	60 (40 ~ 80)	0.04 (0.02 ~ 0.06)
	炭素鋼、合金鋼 Carbon Steel, Alloy Steel (S50C, SCM440)	~280HB	60 (40 ~ 80)	0.07 (0.03 ~ 0.1)	60 (40 ~ 80)	0.04 (0.02 ~ 0.06)
	ダイス鋼 Die Steel (SKD11, SKD61)	~280HB	60 (40 ~ 80)	0.07 (0.03 ~ 0.1)	60 (40 ~ 80)	0.04 (0.02 ~ 0.06)
M	ステンレス鋼(乾式) Stainless Steel (Dry) (SUS304, SUS420)	~250HB	50 (40 ~ 70)	0.07 (0.03 ~ 0.1)	50 (40 ~ 70)	0.04 (0.02 ~ 0.05)
	ステンレス鋼(湿式) Stainless Steel (Wet) (SUS304, SUS420)	~250HB	40 (20 ~ 60)	0.05 (0.03 ~ 0.06)	40 (20 ~ 60)	0.04 (0.02 ~ 0.05)
K	鋳鉄 Cast Iron (FC250)	~350N/mm ²	60 (40 ~ 80)	0.07 (0.03 ~ 0.1)	60 (40 ~ 80)	0.05 (0.02 ~ 0.08)
	ダクタイル鋳鉄 Ductile Cast Iron (FCD400)	~800N/mm ²	60 (40 ~ 80)	0.07 (0.03 ~ 0.1)	60 (40 ~ 80)	0.05 (0.02 ~ 0.08)
N	アルミニウム合金 Aluminum Alloy	~13%Si	190 (80 ~ 300)	0.08 (0.03 ~ 0.12)	190 (80 ~ 300)	0.07 (0.03 ~ 0.1)
S	超耐熱合金(湿式) Superalloy (Wet) (Inconel 718)	-	35 (20 ~ 50)	0.05 (0.03 ~ 0.06)	35 (20 ~ 50)	0.04 (0.02 ~ 0.05)
	チタン合金(湿式) Titanium Alloy (Wet) (Ti-6Al-4V)	-	40 (20 ~ 60)	0.05 (0.03 ~ 0.06)	40 (20 ~ 60)	0.04 (0.02 ~ 0.05)
H	プリハードン鋼 Pre-hardened Steel (NAK80)	40~43HRC	50 (40 ~ 70)	0.07 (0.03 ~ 0.1)	50 (40 ~ 70)	0.04 (0.02 ~ 0.05)
	ダイカスト用鋼 Steel for Die Casting (DAC-MAGIC, DH31)	43~48HRC	40 (30 ~ 50)	0.05 (0.03 ~ 0.08)	40 (30 ~ 50)	0.04 (0.03 ~ 0.06)
	調質鋼 Hardened Steel (SKD11)	50~55HRC	40 (30 ~ 50)	0.05 (0.03 ~ 0.08)	40 (30 ~ 50)	0.04 (0.03 ~ 0.06)

・上記の数値は実切削速度における一般的な値を示したものです。加工環境に合わせて適宜調整して下さい。
 ・ The above cutting conditions are to be used as general guidelines. Adjustments may be necessary depending on actual cutting condition.

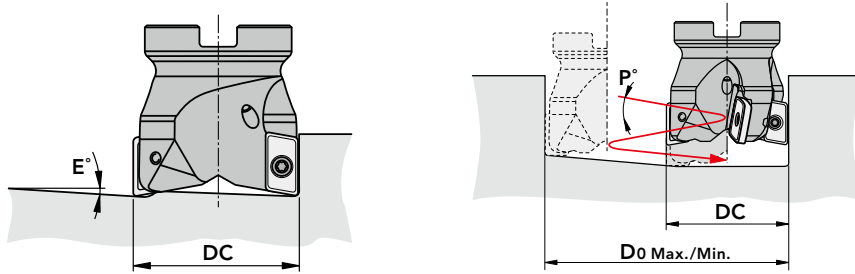

Maximum Ramping (E) & Helical (P) Angle

■ランピング・ヘリカル加工時の最大傾斜角(E) Maximum Ramping (E) & Helical (P) Angle

インサートサイズ Insert Size	ZDKT07...				ZD*T11...				ZDKT15...			
	ランピング 角度 Ramping Angle E°	ヘリカル穴あけ Helical Milling (mm)		ヘリカル 角度 Helical Angle P°	ランピング 角度 Ramping Angle E°	ヘリカル穴あけ Helical Milling (mm)		ヘリカル 角度 Helical Angle P°	ランピング 角度 Ramping Angle E°	ヘリカル穴あけ Helical Milling (mm)		ヘリカル 角度 Helical Angle P°
		最小径 Do Min.	最大径 Do Max.			最小径 Do Min.	最大径 Do Max.			最小径 Do Min.	最大径 Do Max.	
10	6	14	19	4.5	-	-	-	-	-	-	-	-
12	4.5	17	23	2.2	-	-	-	-	-	-	-	-
16	2.8	25	31	1.1	10.8	18	29	9.5	-	-	-	-
17	2.6	27	33	1	9.8	22	31	7.0	-	-	-	-
18	-	-	-	-	9.8	22	33	7.0	-	-	-	-
20	2.1	33	39	0.8	9.8	30	37	7.0	-	-	-	-
21	2	35	41	0.7	8.5	32	39	4.5	-	-	-	-
22	-	-	-	-	7.5	34	41	4.5	-	-	-	-
25	1.6	43	49	0.5	7.5	40	47	4.5	9.5	37	48	7.5
26	1.5	45	51	0.5	6.8	42	49	4.2	8.3	38	50	6.0
28	-	-	-	-	6.3	46	53	3.9	8.3	39	54	5.6
30	-	-	-	-	5.5	50	57	3.4	7.4	43	58	5.3
32	1.1	57	63	0.4	4.8	53	61	3.2	6.8	47	62	5.0
33	-	-	-	-	4.5	56	63	3.0	6.3	49	64	4.2
35	-	-	-	-	3.2	60	67	2.5	5.9	53	68	3.8
40	-	-	-	-	2.9	72	77	2.2	5.1	63	78	3.2
50	-	-	-	-	2.2	93	98	1.7	2.5	86	98	2.5
63	-	-	-	-	1.8	118	123	1.5	2.5	111	124	1.5
80	-	-	-	-	1.4	152	157	1.0	2.0	147	158	1.3
100	-	-	-	-	-	-	-	-	1.5	190	198	1.1
125	-	-	-	-	-	-	-	-	0.9	240	248	0.9

Cutting Data

加工データ Cutting Data

自動旋盤による形状加工 Shape milling with sliding head lathe

使用工具 Tool	PSE07R016SS10-3S (φ16×3刃)		超硬防振型エンドミル自動旋盤対応型 AE-VTSS φ4 Anti-Vibration Carbide End Mill Compatible with Sliding Head Lathes			
使用インサート(材種) Insert (grade)	ZDKT070304SR-GM (XP3035)		-			
被削材 Work Material	SCM435 φ12 バー材 Bar material					
加工部 Milling Part	平面 Face		キー溝 Slot			
加工内容 Milling Process	荒加工 Roughing	仕上げ加工 Finishing	荒加工 Roughing	仕上げ加工 Finishing		
加工方法 Milling Method	Dカット(正面切削) D-cut (Frontal Milling)		突込み切削 Plunging	溝切削 Slot Milling	突込み切削 Plunging	溝切削 Slot Milling
切削速度 Cutting Speed	70m/min (1,393min ⁻¹)		70m/min (5,600min ⁻¹)			
送り速度 Feed	167mm/min (0.04mm/t)		115mm/min (0.021mm/rev)	500mm/min (0.03mm/t)	115mm/min (0.021mm/rev)	500mm/min (0.03mm/t)
切込深さ Depth of Cut	ap=1.4mm 2/パス ae=9.8mm Pass	ap=0.2mm ae=10mm	ap=1.2mm	ap=1.2mm ae=4mm	ap=0.1mm	ap=0.1mm ae=4mm
切削油剤 Coolant			なし* None		※動画撮影のためドライにて加工 Dry machining is used for filming purposes	
使用機械 Machine	CNC自動旋盤 CNC sliding head lathe					

- ・キー溝加工の荒加工は、キー溝深さ2.5mmを確保するため同じ加工を2回行っています。
- ・ For roughing of the slot, the same machining is performed twice to secure a depth of 2.5mm

加工形状 Processed shape

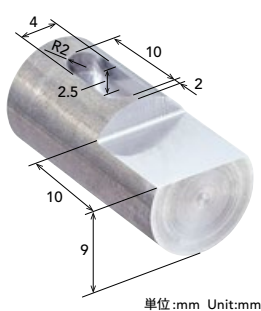

加工動画はこちら
Scan code for video



超硬防振型エンドミル 自動旋盤対応型 AE-VTSS

Anti-Vibration Carbide End Mill Compatible with Sliding Head Lathes

炭素鋼・合金鋼・ステンレス鋼からチタン合金まで
幅広い被削材に対応可能

Compatible with a wide range of work materials from carbon steel, alloy steel, stainless steel to titanium alloy

・スクエアタイプ: φ3 ~ φ12
Square Type

詳細はこちら
Scan for details



S50Cの安定加工 Stable machining in S50C

使用工具 Tool	PSE07R016SS16-4S (φ16×4刃)
使用インサート(材種) Insert (grade)	ZDKT070308SR-GM (XP3035)
被削材 Work Material	S50C
切削速度 Cutting Speed	150m/min (2,986min ⁻¹)
送り速度 Feed	596mm/min (0.05mm/t)
切込深さ Depth of Cut	ap=3.5mm ae=2.5mm
切削油剤 Coolant	なし(エアブロー) Air Blow
使用機械 Machine	立形マシニングセンタ(BT40) Vertical Machining Center



43.2m加工時の摩耗幅: 0.12mm

Wear width after milling 43.2 mm: 0.12 mm

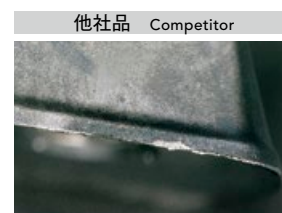

43.2m加工時の摩耗幅: 0.15mm

Wear width after milling 43.2 mm: 0.15 mm

Cutting Data

■加工データ Cutting Data

Inconel 718 (45HRC) の長寿命加工 Long tool life on Inconel 718

使用工具 Tool	PSE11R032SS32-5S (φ32×5刃)	他社品 Competitor
使用インサート(材種) Insert (grade)	ZDKT11T308ER-SM (XC5040)	超硬コーティングインサート Coated Carbide Insert
被削材 Work Material	Inconel 718 (45HRC)	
切削速度 Cutting Speed	30m/min (298min ⁻¹)	25m/min (248min ⁻¹)
送り速度 Feed	120mm/min (0.08mm/t)	80mm/min (0.08mm/t)
切込深さ Depth of Cut	ap=1mm ae=20mm	ap=1mm ae=20mm
切削油剤 Coolant	水溶性切削油剤 Water-Soluble	
使用機械 Machine	立形マシニングセンタ(BT40) Vertical Machining Center	

従来工具よりも50%高い条件にて加工が可能であった。さらに耐久においても2倍以上の耐久が得られ正常摩耗であり、かつ継続加工が可能であった。

Our product was able to mill at conditions that were 50% higher than those for competitors' tools. It provided double the durability with normal wear and was able to continue milling.

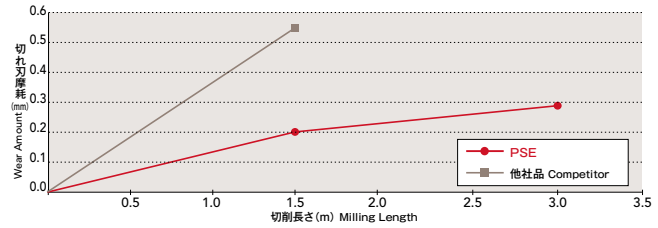

1.5m加工時の写真 After 1.5m of milling

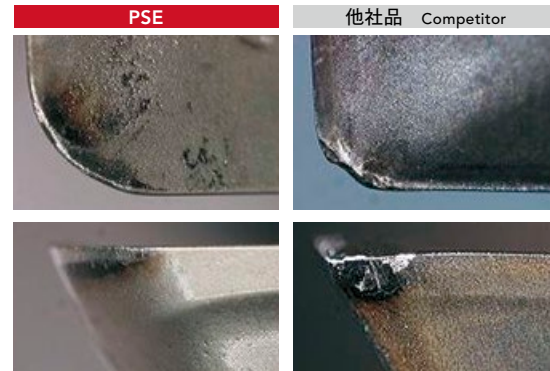

NAK80 (40HRC) の長寿命加工 Long tool life on NAK80 (40HRC)

使用工具 Tool	PSE11R020SS20-3S (φ20×3刃)	他社品 Competitor
使用インサート(材種) Insert (grade)	ZDKT11T308SR-GL (XP2040)	超硬コーティングインサート Coated Carbide Insert
被削材 Work Material	NAK80 (40HRC)	
切削速度 Cutting Speed	130m/min (2,070min ⁻¹)	
送り速度 Feed	1,400mm/min (0.23mm/t)	
切込深さ Depth of Cut	ap=0.3mm ae=10mm	
切削油剤 Coolant	なし(エアブロー) Air Blow	
使用機械 Machine	立形マシニングセンタ(BT50) Vertical Machining Center	

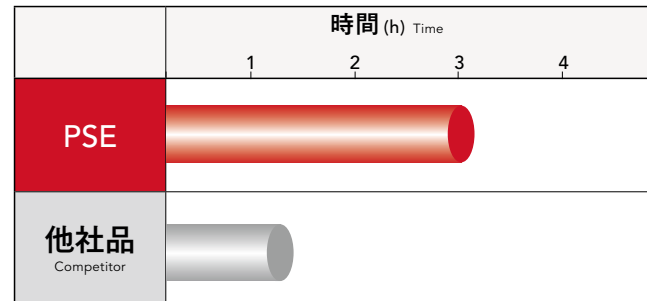

他社品ではインサート欠けが発生してしまうが、PSEは同条件において欠けもなく安定しており約2倍の耐久が得られた。

The competitor's tool chipped, but under the same conditions, the PSE did not exhibit any chipping, performed stably, and provided approximately double the durability.

荒加工の長寿命化 Long tool life in roughing

使用工具 Tool	PSE15R032SS32-3S (φ32×3刃)	他社品 Competitor
使用インサート(材種) Insert (grade)	ZDKT150508SR-GM (XC3030)	超硬コーティングインサート Coated Carbide Insert
被削材 Work Material	S50C	
切削速度 Cutting Speed	180m/min (1,790min ⁻¹)	
送り速度 Feed	1,000mm/min (0.2mm/t)	
切込深さ Depth of Cut	ap=3mm ae=25.2mm	
切削油剤 Coolant	なし(エアブロー) Air Blow	
使用機械 Machine	横形マシニングセンタ(BT50) Horizontal Machining Center	

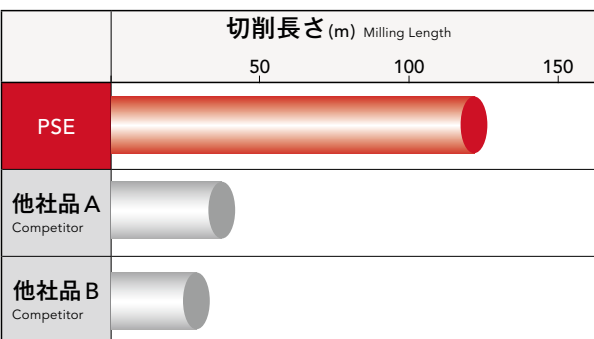

PSE 128m 加工後の写真 Photo after milling 128m

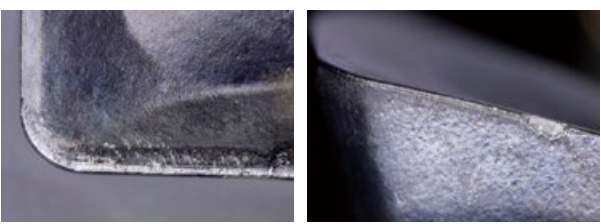

他社品と比較して耐摩耗性が向上。
 摩耗進行を抑えることにより大幅な耐久UPが可能となった。
 In comparison to the competitors, the PSE (XC3030) has much great wear resistance, which leads to longer tool life.

機械部品の正面加工 Face milling of machine parts

使用工具 Tool	PSE15R100M31.7-10 (φ100×10刃)	他社品 Competitor
使用インサート(材種) Insert (grade)	ZDKT150508SR-GM (XP2040)	超硬コーティングインサート Coated Carbide Insert
被削材 Work Material	SUS304	
切削速度 Cutting Speed	150m/min (478min ⁻¹)	
送り速度 Feed	720mm/min (0.15mm/t)	500mm/min (0.15mm/t)
切込深さ Depth of Cut	ap=1mm ae=60mm	
切削油剤 Coolant	水溶性切削油剤 Water-Soluble	
使用機械 Machine	横形マシニングセンタ(BT40) Horizontal Machining Center	
切削量 Cutting Volume	43.2cm ³ /min	30cm ³ /min

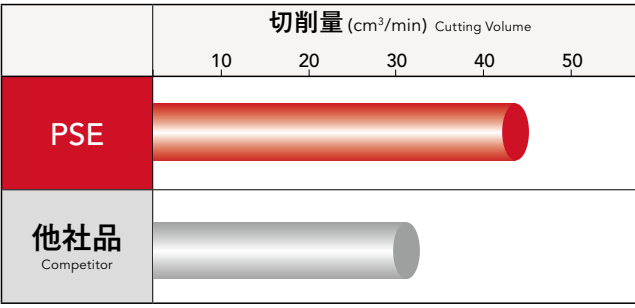

断続加工となる多数の穴があいた箇所の正面加工であったが、他社品に対し1.4倍の能率で加工が可能であった。さらに発熱も抑えられ他社品よりもワークの歪みを抑えることができ、次工程に与える影響も改善することができた。
 This process consisted of intermittent face milling a surface with multiple holes, and our product was able to mill with 1.4 times the efficiency of the competitor's tool. Moreover, it inhibited the generation of heat, reducing the distortion of the workpiece as well as the effects passed on to the subsequent process.

Cutting Data

■加工データ Cutting Data

ノズルピースの溝加工 Groove milling of a nozzle piece

使用工具 Tool	PSE11R020SS20-3S (φ20×3刃)	他社品 Competitor
使用インサート(材種) Insert (grade)	ZDKT11T308ER-SM (XC5040)	超硬コーティングインサート Coated Carbide Insert
被削材 Work Material	SUS630	
切削速度 Cutting Speed	160m/min (2,548min ⁻¹)	
送り速度 Feed	510mm/min (0.07mm/t)	
切込深さ Depth of Cut	ap=2mm ae=20mm	
切削油剤 Coolant	水溶性切削油剤 Water-Soluble	
使用機械 Machine	複合加工機 Compound Machine	

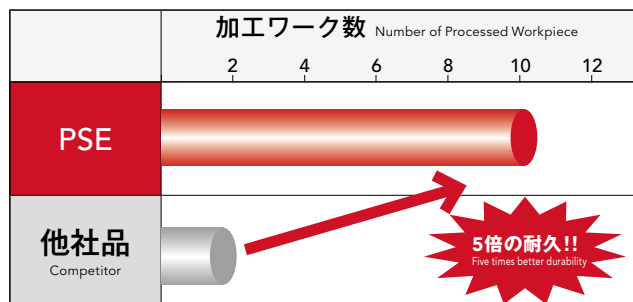

ステンレスの溝加工。他社品では切りくずの噛み込みが発生し早期での欠損が起こっていたが、PSEでは切りくずの排出が安定したため大幅UPの10ワーク加工することが可能であった。

This process consists of groove milling in stainless steel. The competitor's tool caused the chips to jam, resulting in premature breakage of the tool. The PSE, in contrast, evacuated chips in a stable manner and could mill 10 workpieces, a significant improvement.

チャンバー長寿命加工 Long life milling of a chamber

使用工具 Tool	PSE15R080M25.4-8 (φ80×8刃)	他社品 Competitor
使用インサート(材種) Insert (grade)	ZDKT150508SR-GM (XP2040)	超硬コーティングインサート Coated Carbide Insert
被削材 Work Material	SUS304	
切削速度 Cutting Speed	180m/min (717min ⁻¹)	
送り速度 Feed	700mm/min (0.12mm/t)	
切込深さ Depth of Cut	ap=1mm ae=60mm	
切削油剤 Coolant	なし(エアブロー) Air Blow	
使用機械 Machine	横形マシニングセンタ(BT50) Horizontal Machining Center	

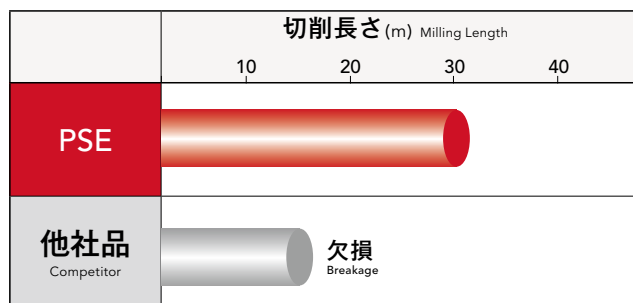

ステンレスのドライ加工。チャンバー開口部における正面加工の同条件下での比較において従来工具は早期で欠損し継続不可となったが、PSEは2倍以上の耐久が得られた。

This process consisted of dry milling in stainless steel. A competitor's tool and the PSE were compared in face milling the surface of a chamber opening under identical conditions. The competitor's tool broke prematurely, and was not able to continue. However, the PSE was able to attain more than double the durability.

航空機部品荒取加工 Rough milling of aircraft parts

使用工具 Tool	PSE11R025SS25-4S (φ25×4刃)	他社品 Competitor
使用インサート(材種) Insert (grade)	ZDKT11T308ER-SM(XC5040)	超硬コーティングインサート Coated Carbide Insert
被削材 Work Material	β-Titanium alloy	
切削速度 Cutting Speed	40m/min (510min ⁻¹)	
1刃当りの送り量 Feed per Tooth	160mm/min (0.08mm/t)	
切込深さ Depth of Cut	ap=5mm ae=10mm	
切削油剤 Coolant	水溶性切削油剤 Water-Soluble	
使用機械 Machine	横形マシニングセンタ(BT40) Horizontal Machining Center	

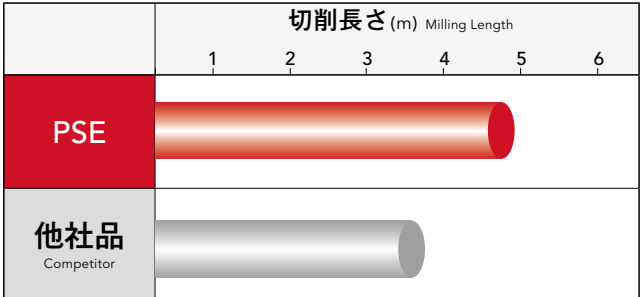

航空機部品の荒取り加工において同等条件で比較加工を行ったが他社品はチッピングが発生。PSEは正常摩耗であり、1.5倍の耐久が得られた。
 A competitor's product and the PSE were compared in the rough milling of aircraft parts under identical conditions. The competitor's product chipped, but the PSE wore normally and attained 1.5 times the durability.

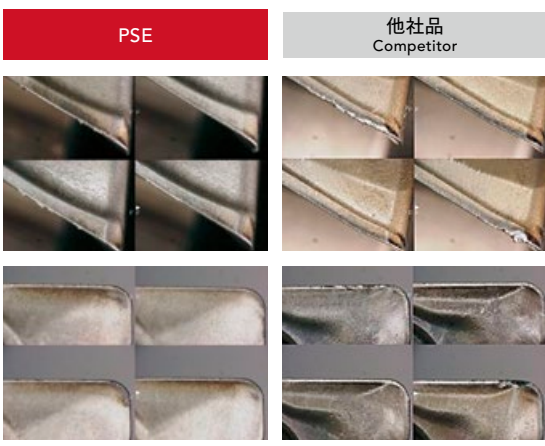

社内試験 DH31S (48HRC) Internal test DH31S (48HRC)

使用工具 Tool	PSE11R032SS32-3S (φ32×3刃)	他社品A、B Competitor
使用インサート(材種) Insert (grade)	ZDKT11T308SR-HR (XP6015)	超硬コーティングインサート Coated Carbide Insert
被削材 Work Material	DH31S (48HRC)	
切削速度 Cutting Speed	50m/min (497min ⁻¹)	
送り速度 Feed	150mm/min (0.1mm/t)	
切込深さ Depth of Cut	ap=5mm ae=1mm	
切削油剤 Coolant	なし(エアブロー) Air Blow	
使用機械 Machine	立形マシニングセンタ(BT40) Vertical Machining Center	

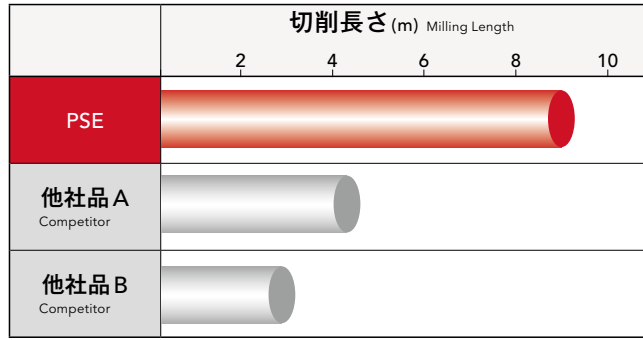

肉盛り部の安定加工 Stable machining of padding

使用工具 Tool	PSE15R032SS32-3S (φ32×3刃)	他社品 Competitor
使用インサート(材種) Insert (grade)	ZDKT11T308SR-HR (XP6015)	超硬コーティングインサート Coated Carbide Insert
被削材 Work Material	肉盛り部 (56HRC) Padding	
切削速度 Cutting Speed	30m/min (300min ⁻¹)	
送り速度 Feed	110mm/min (0.12mm/t)	
切込深さ Depth of Cut	ap=11mm ae=5~20mm	
切削油剤 Coolant	なし(エアブロー) Air Blow	
使用機械 Machine	立形マシニングセンタ(BT50) Vertical Machining Center	

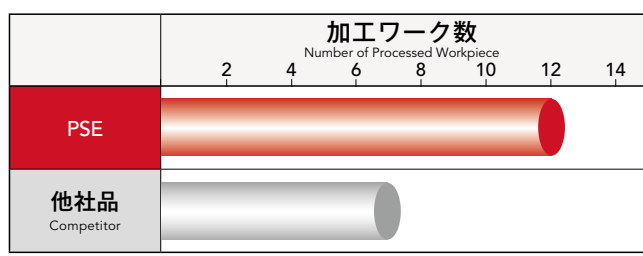

他社品ではインサートの欠損が多発して耐久が安定しなかった。PSE (XP6015)では耐久が安定、さらに約1.7倍の耐久UPが可能となった。
 The competitor tool exhibited frequent insert breakage, which is an indicator for instability. OSG's PSE (XP6015), on the other hand, demonstrated consistent performance with 1.7 times the durability versus the competition.

» Phoenix PSEL

ラフィングエンドミルシリーズ
Roughing End Mill Series

Phoenix Roughing End Mill



■最適化されたインサート配列 Optimized insert arrangement

不等アキシャルレーキ角 (AR)仕様で、振動抑制・低抵抗加工を実現

Variable axial rake angle (AR) suppress vibration which enables low-resistance machining.

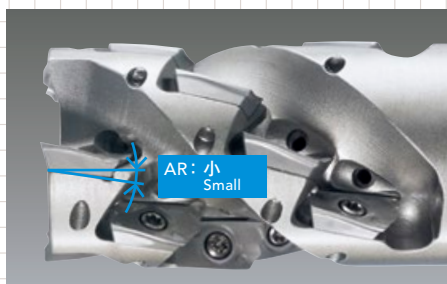

1段目：耐久損性重視
1st step: for high chipping resistance

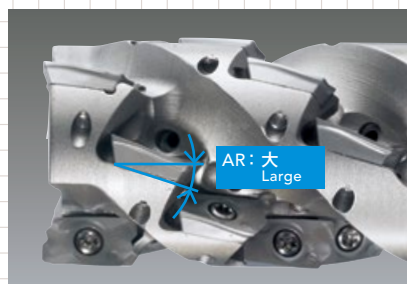

2段目以降：切れ味重視配列
2nd and subsequent steps: for high sharpness

■先端刃インサートの確実なクランプ

Securely clamped inserts at the tip

突発的な刃欠けを抑制し、安定加工が可能

Avoids sudden chipping and enables stable machining



先端刃インサート支持部
Insert support part

■特殊リード溝形状とインサート座ごとのオイルホールで良好な切りくず排出性を実現

A special lead groove and oil hole for every insert seat enable excellent chip ejection

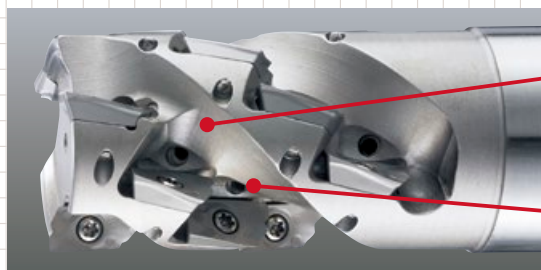

ねじれの強いリード溝
High helix lead groove

オイルホール
Oil hole



■PSEと同じインサートが使える、管理が簡単

Enables to simplify tool management, as inserts for PSEL are interchangeable with those for PSE.

インサートバリエーションが豊富で、様々な加工環境に対応 (p.103参照)

A wide variety of inserts cover the various types of machining (see p.103)



共通インサート
Interchangeable

一部インサートを除く
Some inserts are excluded

Phoenix

ラフィングエンドミル ストレートシャンクタイプ

Roughing End Mill with Straight Shank

PSEL SS

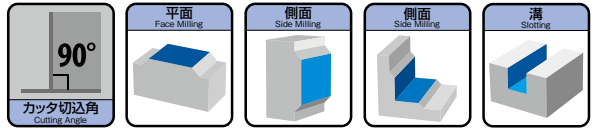

Specification

■形状寸法表 Specification

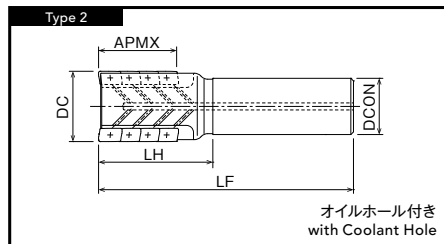
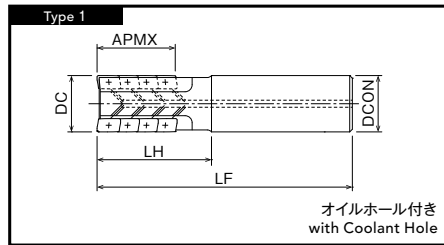

単位:mm Unit:mm

ツールNo. EDP No.	呼び Designation	外径 DC	刃数 ZEPF	刃段数 No. of Insert per Flute	総インサート数 Total No. of Inserts	刃長 APMX	シャンク径 DCON	全長 LF	首下長 LH	重量 (kg)	適用インサート Applicable Inserts	形状 タイプ Type	標準価格 (Yen)
7802900	PSEL11R025SS25-2-27	25	2	3	6	27	25	125	50	0.39	②	1	120,000
7802901	PSEL11R032SS32-2-37	32	2	4	8	37	32	140	60	0.71		1	136,000
7802902	PSEL11R032SS32-3-45	32	3	5	15	45.5	32	140	60	0.7		1	158,000
7802903	PSEL11R040SS42-3-37	40	3	4	12	37	42	140	60	1.2		1	150,000
7802904	PSEL11R040SS42-4-45	40	4	5	20	45.5	42	140	60	1.18		1	181,000
7802905	PSEL15R040SS42-2-38	40	2	3	6	38	42	140	60	1.13	③	1	146,000
7802906	PSEL15R050SS42-3-50	50	3	4	12	50.5	42	144	64	1.31		2	170,000

Phoenix

ラフィングエンドミル ボアタイプ

Roughing End Mill with Bore Type

PSEL BORE

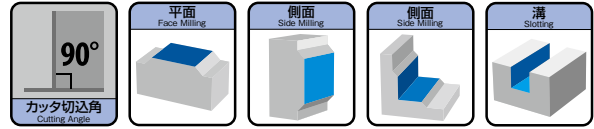

Specification

■形状寸法表 Specification

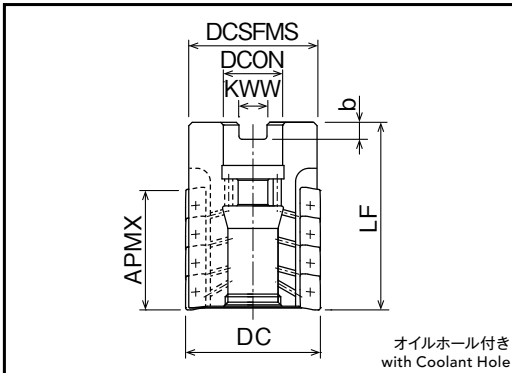



単位:mm Unit:mm

ツールNo. EDP No.	呼び Designation	外径 DC	刃数 ZEFP	刃段数 No. of Insert per Flute	総インサート数 Total No. of Inserts	刃長 APMX	カッタ 高さ LF	ボス径 DCSFMS	穴径 DCON	端面キー溝 Key Slot		重量 (kg)	適用インサート Applicable Inserts	標準価格 (Yen)
										幅 KWW	深さ b			
7802850	PSEL15R050M22-3-50	50	3	4	12	50.5	74	45	22	10.4	6.3	0.47	③	181,000
7802851	PSEL15R063M27-3-50	63	3	4	12	50.5	74	60	27	12.4	7	0.83		187,000
7802852	PSEL15R080M32-4-63	80	4	5	20	63	88	76	32	14.4	8	1.82		203,000

Accessories

■ 部品 Accessories

	ツールNo. EDP No.	呼び Designation	適用インサート Applicable Inserts		適用ボディ Applicable Body
 クランプねじ Clamping Screw	7808107	FS25656P (Torx 8IP)	②	ZD*T11...	PSEL SS φ25
	7808109	FS25673P (Torx 8IP)			PSEL SS φ32~40
	7808115	FS35686P (Torx 15IP)	③	ZDKT15...	PSEL SS φ40~50 PSEL BORE φ50~80
 クーラントキャップボルト Coolant cap bolt	7808132	OCB-M20-08	-	-	PSEL BORE φ50
	7808133	OCB-M24-10	-	-	PSEL BORE φ63
	7808134	OCB-M30-14	-	-	PSEL BORE φ80

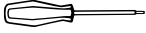
	ツールNo. EDP No.	呼び Designation	適用インサート Applicable Inserts		適用ボディ Applicable Body	標準価格 (Yen)
 レンチ Wrench	7808225	8IP-D (Torx 8IP)	②	ZD*T11...	PSEL SS φ25~40	1,560
	7808228	15IP-D (Torx 15IP)	③	ZDKT15...	PSEL SS φ40~50 PSEL BORE φ50~80	1,820

レンチは別途ご購入下さい。 The wrenches are sold separately from the cutters.

Phoenix

ラフィングエンドミルシリーズ

Roughing End Mill Series

PSELインサート

Inserts

Inserts

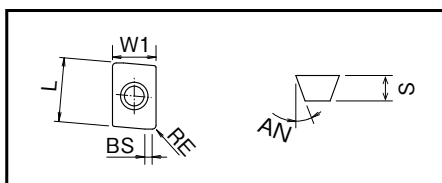

■適用インサート Inserts

呼び Designation	切れ刃数 No. of Cutting Edges	インサート寸法 Insert Size					超硬 Uncoated	CK010
		L×W1	厚さ S	逃げ角 AN	RE	ざらい刃 (副切れ刃) BS		
ZDKT11T302FR-NM	2	11×6.8	3.8	15°	0.2	2.0	7811048	
ZDKT11T304FR-NM	2	11×6.8	3.8	15°	0.4	1.8	7811049	
ZDKT11T308FR-NM	2	11×6.8	3.8	15°	0.8	1.4	7811023	
ZDHT11T302FR-NM	2	11×6.8	3.5	15°	0.2	2.0	7811010	
ZDHT11T304FR-NM	2	11×6.8	3.5	15°	0.4	1.8	7811024	
ZDHT11T308FR-NM	2	11×6.8	3.5	15°	0.8	1.4	7811014	
ZDHT11T312FR-NM	2	11×6.8	3.5	15°	1.2	1.4	7811015	
ZDHT11T316FR-NM	2	11×6.8	3.5	15°	1.6	1.4	7811017	
ZDHT11T320FR-NM	2	11×6.8	3.5	15°	2.0	1.4	7811018	
ZDHT11T325FR-NM	2	11×6.8	3.5	15°	2.5	1.4	7811019	
ZDHT11T332FR-NM	2	11×6.8	3.5	15°	3.2	0.8	7811020	
ZDHT11T340FR-NM	2	11×6.8	3.5	15°	4.0	—	7811021	
ZDHT11T350FR-NM	2	11×6.8	3.5	15°	5.0	—	7811022	
ZDKT11T304SR-GL	2	11×6.8	3.8	15°	0.4	1.8		
ZDKT11T308SR-GL	2	11×6.8	3.8	15°	0.8	1.4		
ZDKT11T312SR-GL	2	11×6.8	3.8	15°	1.2	1.0		
ZDKT11T320SR-GL	2	11×6.8	3.8	15°	2.0	2.1		
② ZDKT11T332SR-GL	2	11×6.8	3.8	15°	3.2	1.5		
ZDKT11T304SR-GM	2	11×6.8	3.8	15°	0.4	1.8		
ZDKT11T308SR-GM	2	11×6.8	3.8	15°	0.8	1.4		
ZDKT11T312SR-GM	2	11×6.8	3.8	15°	1.2	1.0		
ZDKT11T320SR-GM	2	11×6.8	3.8	15°	2.0	2.1		
ZDKT11T325SR-GM	2	11×6.8	3.8	15°	2.5	1.6		
ZDKT11T330SR-GM	2	11×6.8	3.8	15°	3.0	1.5		
ZDKT11T340SR-GM	2	11×6.8	3.8	15°	4.0	—		
ZDKT11T308SR-GR	2	11×6.8	3.8	15°	0.8	1.4		
ZDKT11T308SR-HR	2	11×6.8	3.8	15°	0.8	1.4		
ZDKT11T304ER-SM	2	11×6.8	3.8	15°	0.4	1.8		
ZDKT11T308ER-SM	2	11×6.8	3.8	15°	0.8	1.4		
ZDKT11T312ER-SM	2	11×6.8	3.8	15°	1.2	1.1		
ZDKT11T316ER-SM	2	11×6.8	3.8	15°	1.6	0.8		
ZDKT11T320ER-SM	2	11×6.8	3.8	15°	2.0	0.3		
ZDKT11T325ER-SM	2	11×6.8	3.8	15°	2.5	—		
ZDKT11T332ER-SM	2	11×6.8	3.8	15°	3.2	—		
ZDKT11T340ER-SM	2	11×6.8	3.8	15°	4.0	—		

Phoenix

ラフィングエンドミルシリーズ
Roughing End Mill Series

PSELインサート

Inserts

Inserts

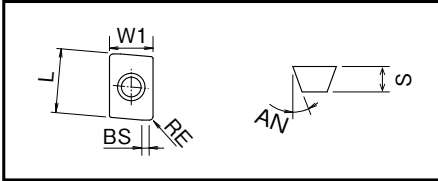

FROM

■適用インサート Inserts

呼び Designation	切れ刃数 No. of Cutting Edges	インサート寸法 Insert Size					超硬 Uncoated	CK010
		L×W1	厚さ S	逃げ角 AN	RE	さらい刃 (副切れ刃) BS		
③	ZDKT150508FR-NM	2	15×9.3	5.56	15°	0.8	1.6	7811046
	ZDKT150508SR-GL	2	15×9.3	5.56	15°	0.8	1.6	
	ZDKT150508SR-GM	2	15×9.3	5.56	15°	0.8	1.6	
	ZDKT150512SR-GM	2	15×9.3	5.56	15°	1.2	1.2	
	ZDKT150516SR-GM	2	15×9.3	5.56	15°	1.6	0.8	
	ZDKT150520SR-GM	2	15×9.3	5.56	15°	2.0	2.1	
	ZDKT150530SR-GM	2	15×9.3	5.56	15°	3.0	1.9	
	ZDKT150540SR-GM	2	15×9.3	5.56	15°	4.0	1.1	
	ZDKT150550SR-GM	2	15×9.3	5.56	15°	5.0	0.7	
	ZDKT150508SR-GR	2	15×9.3	5.56	15°	0.8	1.6	
	ZDKT150508SR-HR	2	15×9.3	5.56	15°	0.8	1.6	
ZDKT150508ER-SM	2	15×9.3	5.56	15°	0.8	1.6		

・2段目以降は、R0.8以下のインサートをご使用下さい。

・コーナR=R2以上のインサートを使用する場合、カッタボディのコーナ部を修正する必要があります。
修正が必要な場合は受注品対応となりますのでご相談下さい。

・ For the 2nd and subsequent steps, use the inserts with R0.8 or smaller.

・ When using an insert with a corner radius of R2 or greater, the corner of the cutter body must be modified.
Please contact us for modification service if necessary.



単位:mm Unit:mm

コーティング材種 Grade of Coated Materials											標準価格 (Yen)
	XC3020	XP3025	XC3030	XP3035	XP2025	XP2040	XC1015	XC5035	XC5040	XP6015	
											2,380
	7827057	7828057	7825057	7814057	7826057	7813057					2,170
	7827028	7828028	7825029	7814029	7826029	7813028	7812029				2,170
				7814077		7813077					2,170
				7814078		7813078					2,170
				7814079		7813079					2,170
				7814080		7813080					2,170
				7814081		7813081					2,170
				7814082		7813082					2,170
	7827058	7828058	7825058	7814058		7813058	7812058				2,170
										7824036	2,170
								7815056	7816056		4,170

Phoenix

ラフィングエンドミルシリーズ

Roughing End Mill Series

PSEL

■被削材別推奨材質

Recommended Materials by Insert Type

◎第一推奨材質 Best
○第二推奨材質 Good

インサート材種 Insert Grades	ブレーカ Insert Breaker	切削油剤 Coolant	P	M	K	N	S	H
CK010	NM	有 Wet				◎		
XC3020	GL GM GR	無 Dry	◎		○			
XP3025	GL GM GR	有 Wet	◎		○			
XC3030	GL GM GR	無 Dry	◎		○			
XP3035	GL GM GR	無 Dry 有 Wet	◎ ○	○ ○	○ ○			

インサート材種 Insert Grades	ブレーカ Insert Breaker	切削油剤 Coolant	P	M	K	N	S	H
XP2025	GL GM	有 Wet	○	◎			○	
XP2040	GL GM GR	無 Dry	○	○				○
		有 Wet	○	◎			○	
XC1015	GM GR	無 Dry			◎			
XC5035	SM	無 Dry		◎				
		有 Wet		○			○	
XC5040	SM	有 Wet		○			◎	
XP6015	HR	無 Dry	○		○			◎

NM:アルミニウム合金用 GL:軽切削用 GM:中切削用 GR:重切削用 HR:高硬度鋼用 SM:耐熱合金用
 NM:Aluminum Alloy GL:Light Cutting GM:Middle Cutting GR:Heavy Cutting HR:High Hardened Steel SM:Heat Resistance Alloy

切込深さ(ap) 1.1~1.5D、
 切込幅(ae) 0.1D以下での条件表です。
 The chart below is based on the following condition:
 ・Depth of Cut (ap) : between 1.1D to 1.5D
 ・Cutting Width (ae) ≤0.1D

■切削条件基準表 Cutting Conditions

被削材 Work Material	引張強さ・硬さ 成分等 Tensile Strength Hardness	インサートサイズ Insert Size			
		ZD*T11...		ZDKT15...	
		切削速度 Vc (m/min) Cutting Speed	一刃当たりの 送り量 fz (mm/t) Feed Per Tooth	切削速度 Vc (m/min) Cutting Speed	一刃当たりの 送り量 fz (mm/t) Feed Per Tooth
P 軟鋼、低炭素鋼 Mild Steel, Carbon Steel (S5400, S10C) 炭素鋼、合金鋼 Carbon Steel, Alloy Steel (S50C, SCM440) ダイス鋼 Die Steel (SKD11, SKD61)	~180HB	160 (100 ~ 200)	0.25 (0.2 ~ 0.4)	160 (100 ~ 200)	0.3 (0.2 ~ 0.4)
	~280HB	150 (100 ~ 200)	0.2 (0.15 ~ 0.3)	150 (100 ~ 200)	0.25 (0.15 ~ 0.3)
	~280HB	130 (80 ~ 180)	0.2 (0.15 ~ 0.3)	130 (80 ~ 180)	0.25 (0.15 ~ 0.3)
M ステンレス鋼(乾式) Stainless Steel (Dry) (SUS304, SUS420) ステンレス鋼(湿式) Stainless Steel (Wet) (SUS304, SUS420)	~250HB	150 (100 ~ 200)	0.12 (0.1 ~ 0.3)	150 (100 ~ 200)	0.15 (0.1 ~ 0.3)
	~250HB	80 (60 ~ 120)	0.12 (0.1 ~ 0.3)	80 (60 ~ 120)	0.15 (0.1 ~ 0.3)
K 鋳鉄 Cast Iron (FC250) ダクタイル鋳鉄 Ductile Cast Iron (FCD400)	~350N/mm ²	160 (100 ~ 300)	0.2 (0.2 ~ 0.35)	160 (100 ~ 300)	0.25 (0.2 ~ 0.35)
	~800N/mm ²	160 (100 ~ 250)	0.15 (0.2 ~ 0.3)	160 (100 ~ 250)	0.2 (0.2 ~ 0.3)
N アルミニウム合金 Aluminum Alloy	~13%Si	300 (200 ~ 1,000)	0.25 (0.1 ~ 0.4)	300 (200 ~ 1,000)	0.3 (0.1 ~ 0.4)
	-	35 (25 ~ 60)	0.15 (0.1 ~ 0.3)	35 (25 ~ 60)	0.18 (0.1 ~ 0.3)
S 超耐熱合金(湿式) Superalloy (Wet) (Inconel 718) チタン合金(湿式) Titanium Alloy (Wet) (Ti-6Al-4V)	-	40 (30 ~ 120)	0.15 (0.1 ~ 0.3)	40 (30 ~ 120)	0.18 (0.1 ~ 0.3)
	-	40 (30 ~ 120)	0.15 (0.1 ~ 0.3)	40 (30 ~ 120)	0.18 (0.1 ~ 0.3)
H プリハードン鋼 Pre-hardened Steel (NAK80) ダイカスト用鋼 Steel for Die Casting (DAC-MAGIC, DH31)	40~43HRC	100 (40 ~ 150)	0.15 (0.1 ~ 0.3)	100 (40 ~ 150)	0.18 (0.1 ~ 0.3)
	43~48HRC	60 (40 ~ 120)	0.12 (0.05 ~ 0.2)	60 (40 ~ 120)	0.15 (0.05 ~ 0.2)

・上記の数値は実切削速度における一般的な値を示したものです。加工環境に合わせて適宜調整して下さい。
 The above cutting conditions are to be used as general guidelines. Adjustments may be necessary depending on actual cutting condition.

■切込深さを変えた時の条件変更の目安 Ratio of cutting condition by cutting depth to the above standard condition

切込深さ Depth of Cut ap (mm)	最大切込幅 Maximum width of Cut ae (mm)	切削速度係数 Ratio to adjust cutting speed VP	送り係数 Ratio to adjust feed rate fP
~ 0.2D	1D	0.8	0.5
0.25 ~ 0.3D	0.7D	0.8	0.6
0.4 ~ 0.5D	0.5D	0.9	0.7
0.6 ~ 0.7D	0.3D	0.9	0.8
0.8 ~ 1D	0.2D	1	0.9
1.1 ~ 1.5D	0.1D	1	1

例 Example
 インサートサイズ ZD*T11...、側面切削
 φ32、ap = 30mm、S50C 切削時
 Insert size ZD*T11..., for cutting φ32, ap=30, side milling,
 for carbon steel (S50C) machining
 ・150m/min(Vc) × 1.0(VP) = 150m/min
 ・0.2mm/t (fz) × 0.9(fP) = 0.18mm/t
 ・ae: 0.2 × φ32 = 6.4mm以下
 or less

Cutting Data

加工データ Cutting Data

FCD450機械系部品の鑄肌内径側面加工 Side milling of the internal circumference of FCD450 machine parts with casting surface

使用工具 Tool	PSEL11R032SS32-3-45 (φ32×3刃)	他社品(φ32×2刃) Competitor
使用インサート(材種) Insert (grade)	ZDKT11T308SR-GR (XP3035)	超硬コーティングインサート Coated Carbide Insert
被削材 Work Material	FCD450	
切削速度 Cutting Speed	100m/min (995min ⁻¹)	80m/min (795min ⁻¹)
送り速度 Feed	600mm/min (0.2mm/t)	240mm/min (0.15mm/t)
切込深さ Depth of Cut	ap=33mm ae=5mm	
切削油剤 Coolant	水溶性切削油剤 Water-Soluble	
工具突出し量 Overhang Length	200mm	
使用機械 Machine	立形マシニングセンタ (BT50) Vertical Machining Center	

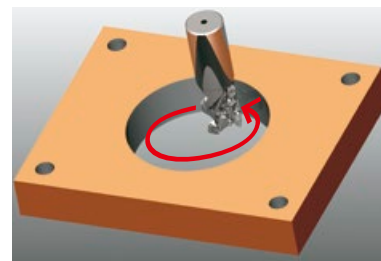
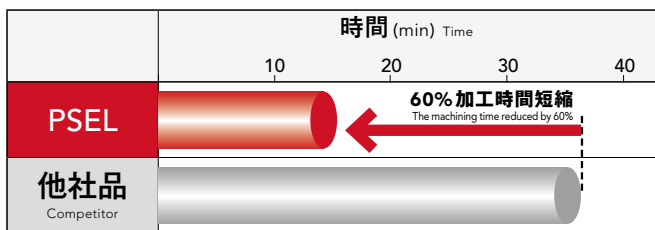

他社品よりも60%加工時間を短縮。加工音は小さく安定した加工で、30ワーク加工後も摩耗が少なかった。また、他社品で発生する突発的な欠けが発生しにくくなった。

The machining time was reduced by 60% compared with the competitor's product. The sound was low with the stable machining. Its wear after machining 30 workpieces was minimal, and sudden chipping, which was occurred by the competitor's product, was unlikely to happen.

プリハードン鋼機械系部品の側面加工 Side milling of pre-hardened steel machine parts

使用工具 Tool	PSEL11R040SS42-3-37 (φ40×3刃)	他社品(φ40×2刃) Competitor
使用インサート(材種) Insert (grade)	ZDKT11T308SR-GR (XP2040)	超硬コーティングインサート Coated Carbide Insert
被削材 Work Material	NAK80 (45HRC)	
切削速度 Cutting Speed	150m/min (1,200min ⁻¹)	
送り速度 Feed	450mm/min (0.13mm/t)	240mm/min (0.1mm/t)
切込深さ Depth of Cut	ap=25mm ae=5mm	
切削油剤 Coolant	水溶性切削油剤 Water-Soluble	
工具突出し量 Overhang Length	180mm	
使用機械 Machine	横形マシニングセンタ (BT50) Horizontal Machining Center	

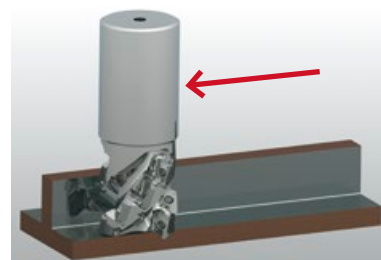
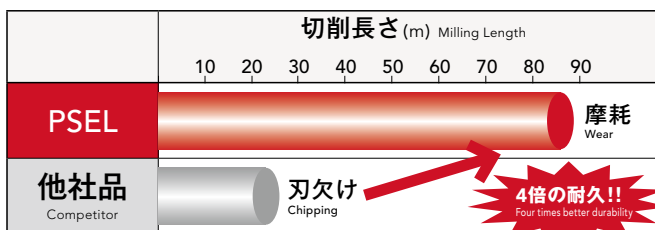

他社品よりも47%加工時間を短縮 (PSEL: 1ワーク10分8秒、他社品: 1ワーク19分)。さらに、工具寿命は約4倍に伸ばすことができ、他社品で発生する突発的な欠けが発生しにくくなった。

The machining time was reduced by 47% (PSEL: 10min. 8sec. per workpiece; the competitor's product: 19 min. per workpiece). Furthermore, the tool life became approximately 4 times, and sudden chipping, which was occurred by the competitor's product, was unlikely to happen.

チタン合金航空機部品の外周側面加工 Side milling of the outer circumference of titanium alloy aircraft parts

使用工具 Tool	PSEL15R063M27-3-50 (φ63×3刃)	他社品(φ63×4刃) Competitor
使用インサート(材種) Insert (grade)	ZDKT150508ER-SM (XC5040)	超硬コーティングインサート Coated Carbide Insert
被削材 Work Material	Ti-6Al-4V (35HRC)	
切削速度 Cutting Speed	50m/min (250min ⁻¹)	
送り速度 Feed	150mm/min (0.2mm/t)	150mm/min (0.15mm/t)
切込深さ Depth of Cut	ap=21~45mm ae=7.5~25mm	
切削油剤 Coolant	水溶性切削油剤 Water-Soluble	
工具突出し量 Overhang Length	300mm	
使用機械 Machine	横形マシニングセンタ (HSK100A) Horizontal Machining Center	

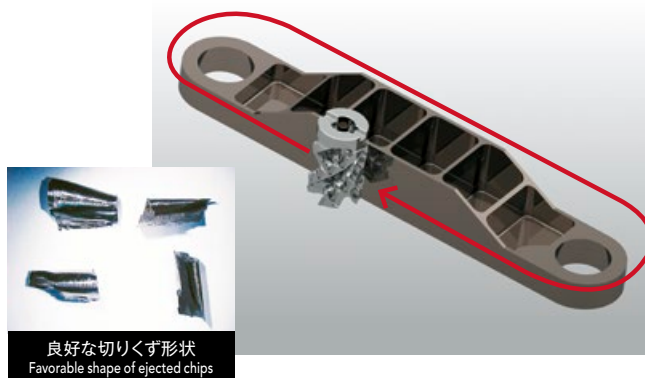

PSELは3ワーク(276分溶着摩耗)、他社品は1ワーク(92分刃欠け)とPSELは他社品に比べ工具寿命が約3倍であった。他社品で発生する欠けが発生しにくく、また切りくず形状も良好であった。

The PSEL achieved 3 times longer tool life (3 workpieces and welding wear after 276 mins) than the competitor tool (1 workpiece and chipping after 92 mins). Moreover, the PSEL was able to maintain consistent chip shape and minimize the risk of sudden chipping.

» Phoenix PSTW

6コーナ肩削りカッタシリーズ
6-corner Shoulder Cutter Series

Phoenix Shoulder Cutter Triangle W-sided Insert Type



■両面6コーナ(90°) インサート

Double-sided 6-corner (90°) insert

剛性を高める厚みと低抵抗なポジすくい角により、
びびり振動に強く、突出しの長い加工に対応

Engineered to effectively process long overhang length applications with strong chattering resistance by a high rigidity and positive rake angle geometry



09サイズは4.64mm Size 09 is 4.64 mm
12サイズは6.55mm Size 12 is 6.55 mm



経済的な裏表3コーナ
(両面6コーナ)仕様

Economical 3-corner per side
(6 corners in total) specification

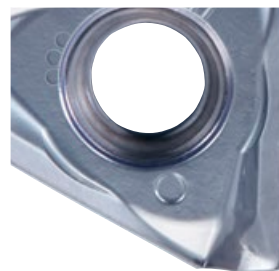

さらい刃により
優れた仕上げ面を実現

Flat cutting edge to enable
excellent surface finish

■高能率加工を実現するボディ設計

A body design engineered for high efficiency machining

最大切込み
09サイズは9mm
12サイズは12mm

Maximum depth of cut:
Size 09 is 9 mm, size 12 is 12 mm

重切削加工に対応したチップポケットにより
高能率加工が可能

Chip pocket uniquely designed for heavy machining to enable
maximum efficiency

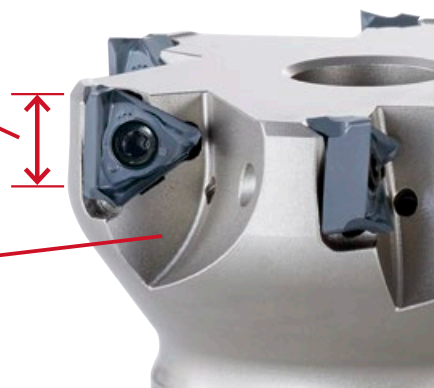

■優れた加工面粗さ Excellent surface roughness

使用工具 Tool	PSTW12R050M22-4 (φ50×4刃) Flutes	
使用インサート(材種) Insert (grade)	TNKU120608ER-GM (XP3035)	
被削材 Work Material	S50C	
切削速度 Cutting Speed	200m/min (1,274min ⁻¹)	
送り速度 Feed	510mm/min (0.1mm/t)	
切込深さ Depth of Cut	ap=0.2mm ae=32mm	
切削油剤 Coolant	なし(エアブロー) Air Blow	
使用機械 Machine	横形マシニングセンタ(BT50) Horizontal Machining Center	

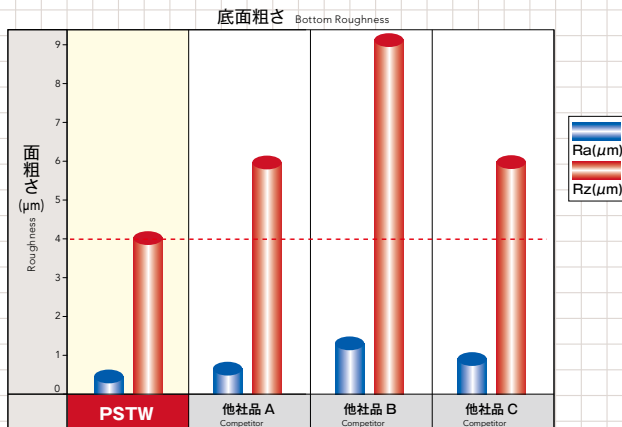

■突出しの長い加工でも高能率 High efficiency even in long overhang length applications

使用工具 Tool	PSTW12R050M22-4 (φ50×4刃) Flutes	他社肩割りボジカッタ (φ50×5刃) Flutes Competitor's Single Sided Insert Cutter
使用インサート(材種) Insert (grade)	TNKU120608ER-GM (XP3035)	超硬コーティングインサート Coated Carbide Insert
被削材 Work Material	S50C	
切削方法 Cutting Method	溝加工 Slot Milling	
切込深さ Depth of Cut	ap=3mm ae=50mm	
突出し長さ Overhang Length	190mm (3.8D)	
切削油剤 Coolant	なし(エアブロー) Air Blow	
使用機械 Machine	横形マシニングセンタ(BT50) Horizontal Machining Center	

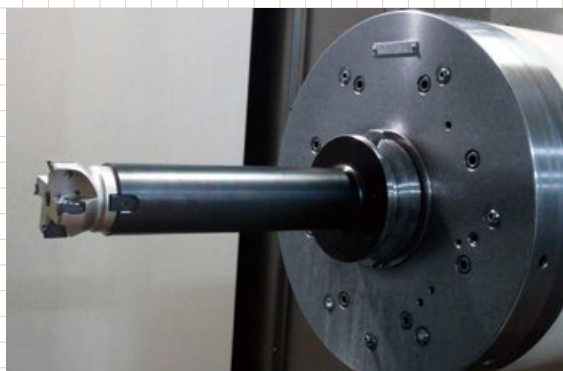
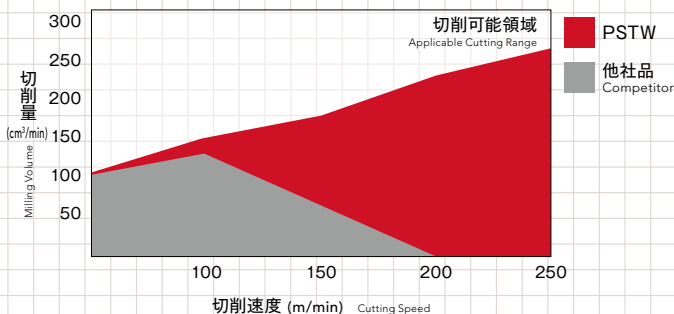

■加工用途に合わせたインサートバリエーション

Variations of application based on inserts

ブレーカ Insert Breaker	NM	GL	GM	GR	SM
用途 Application	アルミニウム合金・ 非鉄金属加工 Aluminum alloy & Non-ferrous metal	低抵抗加工 Low-resistance machining	汎用加工 一般鋼加工 Multi-purpose machining & General steel milling	断続加工 鋳鉄加工 Intermittent machining & Cast iron machining	耐熱合金 難削材加工 Superalloy & Difficult-to-machine material

Phoenix

6コーナ肩削りカッタ ストレートシャンクタイプ

6-corner Shoulder Cutter Straight Shank Type

PSTW SS

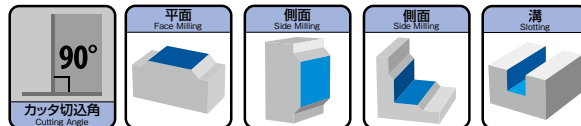

Specification

■形状寸法表 Specification

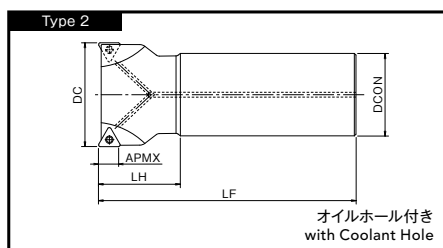
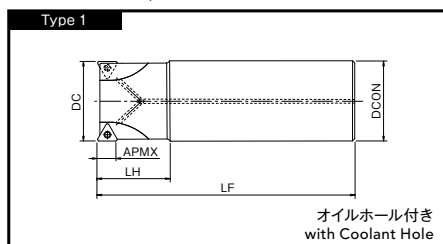

単位:mm Unit:mm

ツールNo. EDP No.	呼び Designation	外径 DC	刃数 ZFP	シャンク径 DCON	全長 LF	首下長 LH	APMX	重量 (kg)	適用インサート Applicable Inserts	形状タイプ Type	標準価格 (Yen)
NEW 7803014	PSTW09R025SS25-2S	25	2	25	120	35	9	0.41	①	1	33,100
NEW 7803015	PSTW09R025SS25-2L	25	2	25	170	70	9	0.58		1	36,100
NEW 7803016	PSTW09R025SS25-3S	25	3	25	120	35	9	0.4		1	44,300
NEW 7803017	PSTW09R026SS25-2L	★26	2	25	170	35	9	0.59		2	36,400
NEW 7803018	PSTW09R028SS25-2L	★28	2	25	170	35	9	0.6		2	37,000
NEW 7803019	PSTW09R028SS25-3S	★28	3	25	120	35	9	0.41		2	45,200
NEW 7803020	PSTW09R030SS32-2L	30	2	32	190	90	9	1.02		1	38,800
NEW 7803021	PSTW09R030SS32-3S	30	3	32	130	45	9	0.7		1	46,500
NEW 7803022	PSTW09R032SS32-3S	32	3	32	130	45	9	0.74		1	46,800
NEW 7803023	PSTW09R032SS32-3L	32	3	32	190	45	9	1.1		1	50,600
NEW 7803024	PSTW09R032SS32-4S	32	4	32	125	40	9	0.7		1	57,700
NEW 7803025	PSTW09R033SS32-3L	★33	3	32	190	35	9	1.1		2	50,900
NEW 7803026	PSTW09R035SS32-3L	★35	3	32	190	35	9	1.12		2	51,600
NEW 7803027	PSTW09R035SS32-4S	★35	4	32	130	35	9	0.75		2	58,600
NEW 7803028	PSTW09R040SS32-4S	40	4	32	140	50	9	0.85		2	60,900
NEW 7803029	PSTW09R040SS32-4L	40	4	32	190	45	9	1.15		2	65,200
NEW 7803030	PSTW09R040SS32-5S	40	5	32	140	50	9	0.84		2	72,200

★ 刃太タイプ

Reduced Shank Type

★ PSTW 刃太タイプ Reduced Shank Type

・刃太タイプは、シャンク径よりも工具外径の方が大きいので、金型部品などの深い立ち壁加工やポケット加工に最適です

・The outer diameter of the reduced shank type is larger than the shank diameter, making it highly effective in the processing of die and mold applications that require vertical wall milling or pocketing.

例
Example

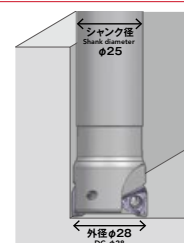

Phoenix

6コーナ肩削りカッタ ボアタイプ

6-corner Shoulder Cutter Bore Type

PSTW BORE

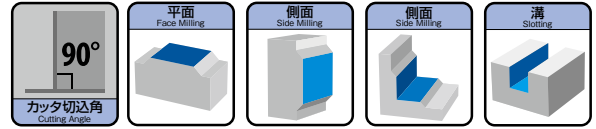

Specification

■形状寸法表 Specification

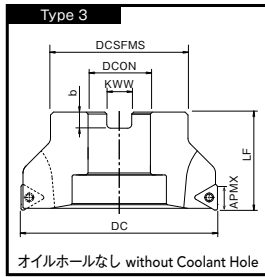
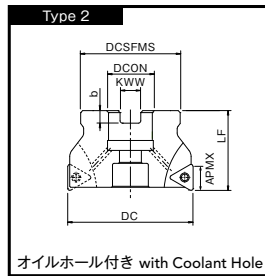
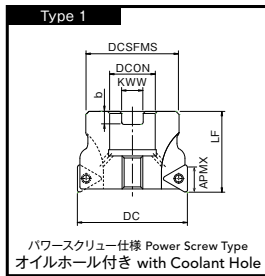

単位:mm Unit:mm

ツールNo. EDP No.	呼び Designation	外径 DC	刃数 ZEPF	カッタ 高さ LF	ボス径 DCSFMS	穴径 DCON	端面キー溝 Key Slot		APMX	重量 (kg)	適用インサート Applicable Inserts	形状 タイプ Type	標準価格 (Yen)
							幅 KWW	深さ b					
NEW 7803031	PSTW09R040M16-4	40	4	40	38	16	8.4	5.6	9	0.23	①	2	57,700
NEW 7803032	PSTW09R040M16-5	40	5	40	38	16	8.4	5.6	9	0.23		2	69,000
NEW 7803033	PSTW09R050M22-4	50	4	40	45	22	10.4	6.3	9	0.33		2	69,800
NEW 7803034	PSTW09R050M22-6	50	6	40	45	22	10.4	6.3	9	0.32		2	80,700
NEW 7803035	PSTW09R063M22-5	63	5	40	50	22	10.4	6.3	9	0.52		2	71,400
NEW 7803036	PSTW09R063M22-7	63	7	40	50	22	10.4	6.3	9	0.52		2	93,700
7803100	PSTW12R050M22-3	50	3	40	45	22	10.4	6.3	12	0.3	②	1	59,400
7803101	PSTW12R050M22-4	50	4	40	45	22	10.4	6.3	12	0.3		1	71,400
7803102	PSTW12R063M22-3	63	3	40	50	22	10.4	6.3	12	0.48		2	63,900
7803103	PSTW12R063M22-5	63	5	40	50	22	10.4	6.3	12	0.46		2	82,100
7803104	PSTW12R080M25.4-5	80	5	50	60	25.4	9.5	6	12	1.08		2	84,800
7803110	PSTW12R080M27-5	80	5	50	60	27	12.4	7	12	1.07		2	84,800
7803105	PSTW12R080M25.4-6	80	6	50	60	25.4	9.5	6	12	1.06		2	111,000
7803111	PSTW12R080M27-6	80	6	50	60	27	12.4	7	12	1.04		2	111,000
7803106	PSTW12R100M31.7-5	100	5	50	70	31.75	12.7	8	12	1.5		3	100,000
7803112	PSTW12R100M32-5	100	5	50	70	32	14.4	8	12	1.57		2	100,000
7803107	PSTW12R100M31.7-7	100	7	50	70	31.75	12.7	8	12	1.5		3	115,000
7803113	PSTW12R100M32-7	100	7	50	70	32	14.4	8	12	1.56		2	115,000
7803108	PSTW12R125M38.1-7	125	7	63	90	38.1	15.9	10	12	3.03		3	132,000
7803114	PSTW12R125M40-7	125	7	63	90	40	16.4	9	12	2.96		2	132,000
7803109	PSTW12R125M38.1-9	125	9	63	90	38.1	15.9	10	12	3.01		3	142,000
7803115	PSTW12R125M40-9	125	9	63	90	40	16.4	9	12	2.93	2	142,000	

在庫区分は全てC(標準在庫品)となります。 Stock are categorized as C (Standard stock item).

Phoenix

6コーナ肩削りカッタ

6-corner Shoulder Cutter

インサート

Inserts

Inserts

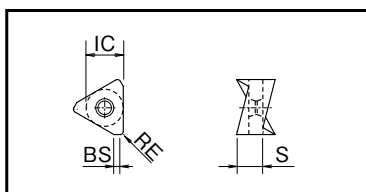

■適用インサート Inserts

単位:mm Unit:mm

呼び Designation	切れ刃数 Number of Cutting Edges	インサート寸法 Insert Size					超硬 Uncoated		コーティング材種 Grade of Coated Materials							標準価格 (Yen)	
		内接円径 IC	厚さ S	RE	ざらい刃 (割切れ刃) BS	CK010	XC3020	XP3025	XC3030	XP3035	XP2040	XC1015	XP1020	XC5040			
NEW TNHU090404FR-NM	6	7.46	4.64	0.4	1.15	7813104											2,590
NEW TNKU090404ER-GL	6	7.46	4.64	0.4	1.2				7821095	7813101	7813100						2,170
NEW TNKU090404ER-GM	6	7.46	4.64	0.4	1.2		7821091	7821092	7821093	7813097	7813098	7813099	7821094				2,170
① NEW TNKU090408ER-GM	6	7.46	4.64	0.8	0.9					7813105	7813106						2,170
NEW TNKU090412ER-GM	6	7.46	4.64	1.2	0.6					7813107	7813108						2,170
NEW TNKU090404ER-GR	6	7.46	4.64	0.4	1.2							7813102	7821096				2,170
NEW TNKU090404ER-SM	6	7.46	4.64	0.4	1.2										7813103		2,670
TNHU120608ER-NM	6	10.8	6.55	0.8	1.25	7811087											3,420
TNKU120608ER-GL	6	10.8	6.55	0.8	1.5					7825089	7814089	7813089					3,020
TNKU120608ER-GM	6	10.8	6.55	0.8	1.5		7827088	7828088	7825088	7814088	7813088	7812088	7821088				3,020
② TNKU120612ER-GM	6	10.8	6.55	1.2	1					7814094	7813094						3,020
TNKU120616ER-GM	6	10.8	6.55	1.6	0.75					7814095	7813095						3,020
TNKU120620ER-GM	6	10.8	6.55	2	0.6					7814096	7813096						3,020
TNKU120608ER-GR	6	10.8	6.55	0.8	1.5							7812090	7821090				3,020
TNKU120608ER-SM	6	10.8	6.55	0.8	1.5										7816091		3,660

Accessories

■部品 Accessories

	ツールNo. EDP No.	呼び Designation	適用インサート Applicable Inserts	適用ボディ Applicable Body
クランプねじ Clamping Screw	7808097	FS30668 (Torx 8)	① TN*U09...	PSTW SS φ25~40 PSTW BORE φ40~63
	7808129	FS40511 (Torx 15)	② TN*U12...	PSTW BORE φ50~125
パワースクリュー Power Screw	7808151	PS1031 (M10×31)	② TN*U12...	PSTW BORE φ50

	ツールNo. EDP No.	呼び Designation	適用インサート Applicable Inserts	適用ボディ Applicable Body	標準価格 (Yen)
レンチ Wrench	7808205	T8-D (Torx 8)	① TN*U09...	PSTW SS φ25~40 PSTW BORE φ40~63	1,190
	7808208	T15-D (Torx 15)	② TN*U12...	PSTW BORE φ50~125	1,260

レンチは別途ご購入下さい。 The wrenches are sold separately from the cutters.

Phoenix

6コーナ肩削りカッタ 6-corner Shoulder Cutter

PSTW

Cutting Conditions

被削材別推奨材質

Recommended Materials by Insert Type

◎第一推奨材質 Best
○第二推奨材質 Good

インサート材種 Insert Grades	ブレーカ Insert Breaker	切削油剤 Coolant	P	M	K		N	S	H
					FC	FCD			
CK010	NM	有 Wet					◎		
XC3020	GM	無 Dry	◎		○				
XP3025	GM	有 Wet	◎		○				
XC3030	GL GM	無 Dry	◎		○				
XP3035	GL GM	無 Dry	◎	○	○				
		有 Wet							
XP2040	GL GM	無 Dry	○	○					○
		有 Wet	○	◎				○	
XC1015	GM GR	無 Dry			◎	○			
XP1020	GM GR	無 Dry			○	◎			
		有 Wet							
XC5040	SM	有 Wet		○				◎	

NM:アルミニウム合金用 GL:軽切削用 GM:中切削用 GR:重切削用 SM:耐熱合金用
NM:Aluminum Alloy GL:Light Cutting GM:Middle Cutting GR:Heavy Cutting SM:Superalloy

切削条件基準表 Cutting Conditions

被削材 Work Material	引張強さ・硬さ Tensile Strength・Hardness	切削速度 VC (m/min) Cutting Speed	インサートサイズ Insert Size			
			TN*U09...		TN*U12...	
			一刃当たりの送り量 fz (mm/t) Feed per Tooth	切込深さ ap (mm) Depth of Cut	一刃当たりの送り量 fz (mm/t) Feed per Tooth	切込深さ ap (mm) Depth of Cut
P 軟鋼、低炭素鋼 Mild Steel, Carbon Steel (SS400, S10C) 炭素鋼、合金鋼 Carbon Steel, Alloy Steel (S50C, SCM440)	~180HB	180 (100 ~ 250)	0.12 (0.05 ~ 0.2)	2	0.15 (0.05 ~ 0.25)	3
	~280HB	180 (100 ~ 250)	0.12 (0.05 ~ 0.2)	2	0.15 (0.05 ~ 0.25)	3
M ダイス鋼 Die Steel (SKD11, SKD61) ステンレス鋼(乾式) Stainless Steel (Dry) (SUS304, SUS420) ステンレス鋼(湿式) Stainless Steel (Wet) (SUS304, SUS420)	~280HB ~250HB	150 (80 ~ 200) 150 (80 ~ 200)	0.1 (0.05 ~ 0.18) 0.08 (0.05 ~ 0.16)	2 1.5	0.12 (0.05 ~ 0.2) 0.1 (0.05 ~ 0.18)	3 2
K 铸铁 Cast Iron (FC250) ダクタイル铸铁 Ductile Cast Iron (FCD400)	~350N/mm ² ~800N/mm ²	200 (100 ~ 350) 180 (100 ~ 270)	0.15 (0.05 ~ 0.25) 0.12 (0.05 ~ 0.2)	2 2	0.2 (0.1 ~ 0.3) 0.15 (0.05 ~ 0.25)	3 3
N アルミニウム合金 Aluminum Alloy	~13%Si	300 (200 ~ 1,500)	0.12 (0.08 ~ 0.25)	2	0.15 (0.1 ~ 0.3)	3
S 耐熱合金(湿式) Heat Resistant Alloy (Wet) (Inconel 718) チタン合金(湿式) Titanium Alloy (Wet) (Ti-6Al-4V)	- -	35 (25 ~ 60) 40 (30 ~ 120)	0.06 (0.04 ~ 0.1) 0.06 (0.04 ~ 0.1)	0.8 1	0.08 (0.05 ~ 0.15) 0.08 (0.05 ~ 0.15)	1 1.5
H プリハードン鋼 Pre-hardened Steel (NAK80) ダイカスト用鋼 Steel for Die Casting (DAC-MAGIC, DH31) 調質鋼 Hardened Steel (SKD11)	40~43HRC 43~48HRC 50~55HRC	100 (50 ~ 150) 80 (40 ~ 120) 60 (40 ~ 90)	0.08 (0.06 ~ 0.15) 0.06 (0.05 ~ 0.13) 0.05 (0.04 ~ 0.08)	1 0.8 0.4	0.1 (0.08 ~ 0.2) 0.08 (0.06 ~ 0.15) 0.06 (0.05 ~ 0.1)	1.5 1 0.5

・上記の数値は実切削速度における一般的な値を示したものです。加工環境に合わせて適宜調整して下さい。
・ The above cutting conditions are to be used as general guidelines. Adjustments may be necessary depending on actual cutting condition.

Drilling 穴加工
Milling フライス加工
PXD
PD
PHP
PDZ
PZAG
PLDS
PAS
PAO
PSF
PSFL
PSE
PSEL
PSTW
PMD
PHC
PRC
PDR
PFAL
PFB
PFR
SF
PXM
PXM
Technical data 技術資料
Index 索引

Cutting Data

■加工データ Cutting Data

S50Cの長寿命加工 Long tool life in S50C

使用工具 Tool	PSTW09R025SS25-3S (φ25×3刃) Flutes	他社品 Competitor (φ25×3刃) Flutes
使用インサート(材種) Insert (grade)	TNKH090404ER-GM (XP3035)	超硬コーティングインサート Coated Carbide Insert
被削材 Work Material	S50C	
切削速度 Cutting Speed	180m/min (2,290min ⁻¹)	
送り速度 Feed	825mm/min (0.12mm/t)	
切込深さ Depth of Cut	ap=2mm ae=16mm	
切削油剤 Coolant	なし(エアブロー) Air Blow	
使用機械 Machine	立形マシニングセンタ(BT40) Vertical Machining Center	

他社品と比較して耐摩耗性に優れており、約4.5倍の耐久性能が得られた。
The PSTW demonstrates greater wear resistance and achieves approximately 4.5 times the durability versus the competitor tool.

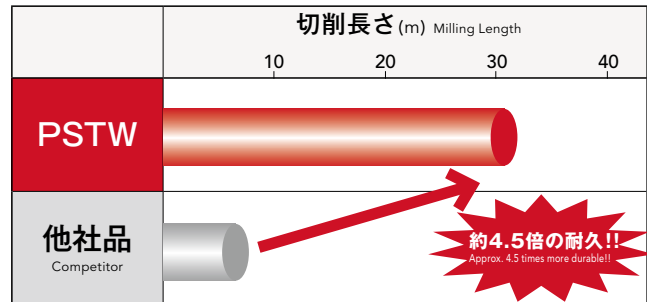

7m加工時の写真
After machining 7m

PSTW

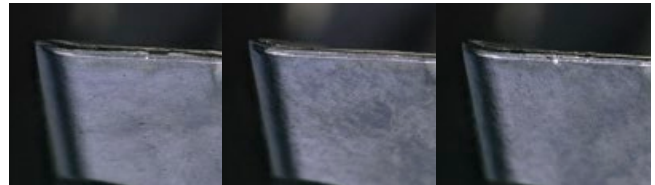

他社品
Competitor

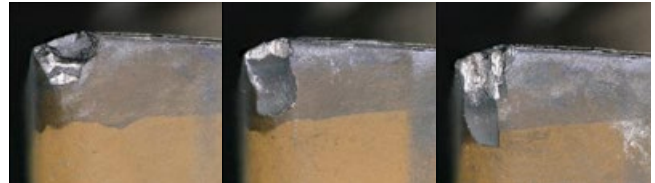

SUS304の長寿命加工 Long tool life in SUS304

使用工具 Tool	PSTW09R025SS25-3S (φ25×3刃) Flutes	他社品 Competitor (φ25×3刃) Flutes
使用インサート(材種) Insert (grade)	TNKH090404ER-GL (XP2040)	超硬コーティングインサート Coated Carbide Insert
被削材 Work Material	SUS304	
切削速度 Cutting Speed	150m/min (1,910min ⁻¹)	
送り速度 Feed	460mm/min (0.08mm/t)	
切込深さ Depth of Cut	ap=1.5mm ae=16mm	
切削油剤 Coolant	なし(エアブロー) Air Blow	
使用機械 Machine	立形マシニングセンタ(BT40) Vertical Machining Center	

他社品の耐久限界の約1.5倍となる10.5mまで加工を行ったが、インサートは欠けもなく継続加工が可能な状態であった。

The PSTW demonstrates about 1.5 times the durability versus the competitor tool, and its inserts exhibit no chipping and can continued to be used after milling 10.5 m.

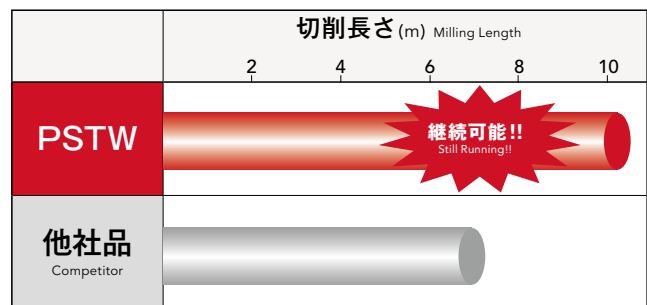

7m加工時の写真
After machining 7m

PSTW



他社品
Competitor



プレス金型構造物スライド面の高精度加工 High-precision machining of press mold slide surface

使用工具 Tool	PSTW12R050M22-4 (φ50×4刃) Flutes
使用インサート(材種) Insert (grade)	TNKU120608ER-GR (XP1020)
被削材 Work Material	FCD500
切削速度 Cutting Speed	300m/min (1,910min ⁻¹)
送り速度 Feed	1,700mm/min (0.2mm/t)
切込深さ Depth of Cut	a _p =0.5mm a _e =0.3mm
突出し長さ Overhang Length	240mm
切削油剤 Coolant	なし(エアブロー) Air Blow
使用機械 Machine	門形マシニングセンタ (BT50) Double Column Machining Center

側面仕上げ加工において、倒れ量10μm以下という要求精度を満たし良好な加工面精度が得られる結果となった。

The PSTW was able to achieve excellent surface precision during side finishing, satisfying the required run-out accuracy of under 10μm.

側面粗さ Side Roughness

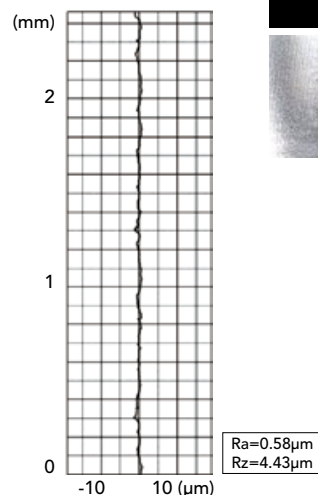

SUS304の高効率加工 High efficiency machining of SUS304

使用工具 Tool	PSTW12R050M22-4 (φ50×4刃) Flutes	他社肩削りボジカッタ (φ50×5刃) Competitor's Single Sided Insert Cutter Flutes
使用インサート(材種) Insert (grade)	TNKU120608ER-GL (XP2040)	超硬コーティングインサート Coated Carbide Insert
被削材 Work Material	SUS304	
切削速度 Cutting Speed	150m/min (955min ⁻¹)	
送り速度 Feed	700mm/min (0.18mm/t)	700mm/min (0.15mm/t)
切込深さ Depth of Cut	a _p =5mm a _e =35mm	a _p =3mm a _e =35mm
切削油剤 Coolant	水溶性切削油剤 Water-Soluble	
使用機械 Machine	門形マシニングセンタ (BT50) Double Column Machining Center	

他社品では切込深さ(a_p)が上がるとびびり振動が発生し、能率が上げられない。さらにバリも発生。PSTWは1刃少ないが、能率67%UPの高効率加工が可能であった。

With the increase of depth of cut (a_p), the competitor tool exhibited chattering and burrs, which hindered further efficiency improvement. Whereas the PSTW, even with one less corner, was able to increase machining efficiency by 67%, allowing high productivity.

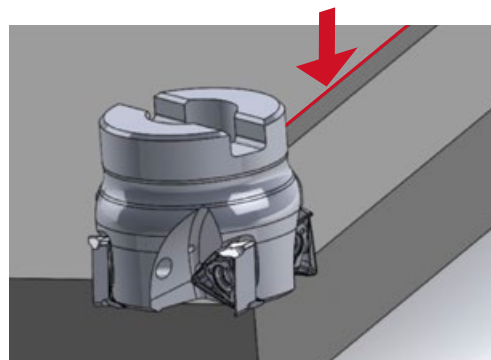
PSTW : バリ発生(小)
Small amount of burrs他社品 : バリ発生(大)
Competitor : Large amount of burrs

Cutting Data

■加工データ Cutting Data

建機コントロールバルブ荒加工 Rough milling of construction machinery control valve

使用工具 Tool	PSTW12R063M22-5 (φ63×5刃) Flutes	他社肩削りネガカッタ (φ63×5刃) Flutes Competitor's Double Sided Insert Cutter
使用インサート(材種) Insert (grade)	TNKH120608ER-GR (XP1020)	超硬コーティングインサート Coated Carbide Insert
被削材 Work Material	FCD500	
切削速度 Cutting Speed	180m/min (910min ⁻¹)	
送り速度 Feed	1,000mm/min (0.22mm/t)	
切込深さ Depth of Cut	ap=3mm ae=45mm	
切削油剤 Coolant	なし(エアブロー) Air Blow	
使用機械 Machine	横形マシニングセンタ(BT50) Horizontal Machining Center	

他社品と比較した結果、耐摩耗性に優れていた。特に切込み境界部の摩耗進行を抑えられて、約3.5倍の耐久UPが可能となった。

The PSTW demonstrated much greater wear resistance versus the competitor tool. In particular, it was able to effectively suppress wear progress of the cutting edge and achieved 3.5 times the durability versus the competitor.

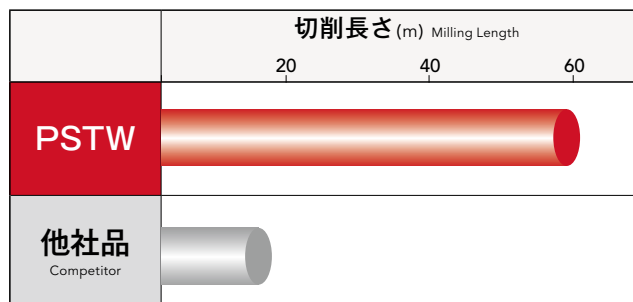

17m 加工時の写真
After machining 17m

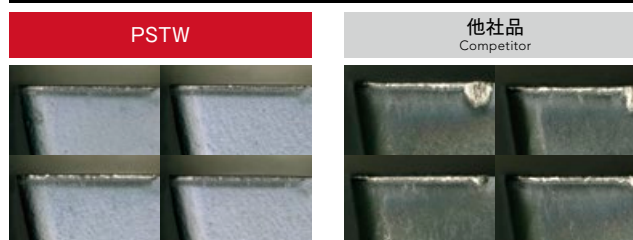

Ti-6Al-4Vの長寿命加工 Long tool life in Ti-6Al-4V

使用工具 Tool	PSTW12R050M22-4 (φ50×4刃) Flutes	他社肩削りネガカッタA, B (φ50×4刃) Flutes Competitors' Double Sided Insert Cutter
使用インサート(材種) Insert (grade)	TNKH120608ER-SM (XC5040)	超硬コーティングインサート Coated Carbide Insert
被削材 Work Material	Ti-6Al-4V	
切削速度 Cutting Speed	40m/min (255min ⁻¹)	
送り速度 Feed	82mm/min (0.08mm/t)	
切込深さ Depth of Cut	ap=1.5mm ae=20mm	
切削油剤 Coolant	なし(エアブロー) Air Blow	
使用機械 Machine	横形マシニングセンタ(BT50) Horizontal Machining Center	

他社品(裏表3コーナ仕様)は早期に摩耗進行・チッピングが発生。PSTW (XC5040)では摩耗の抑制により耐久UPが可能となった。

The PSTW (XC5040) was able to suppress wear resistance to prolong durability whereas the competitor equivalent product (double sided triangle insert) exhibited early wear and chipping.

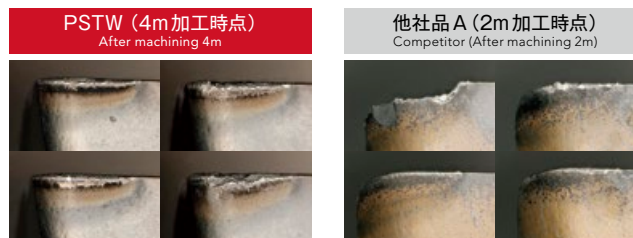
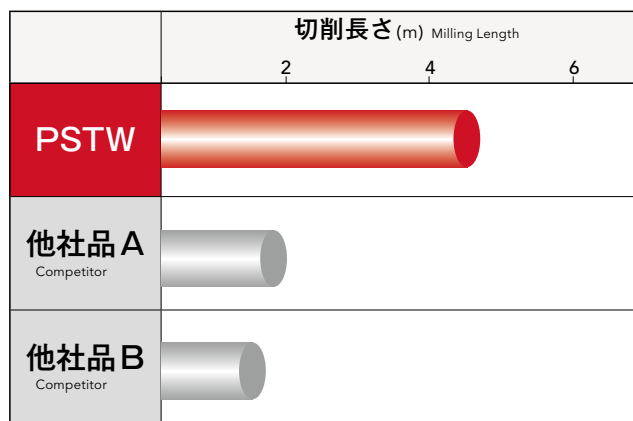

突出し長さ300mm(5D)の高効率安定加工 Highly efficient stable processing of long overhang length of 300 mm (5D)

使用工具 Tool	PSTW12R063M22-5 (φ63×5刃) Flutes	他社肩削りネガカッタ(φ63×4刃) Competitor's Double Sided Insert Cutter
使用インサート(材種) Insert (grade)	TN KU120608ER-GM (XC3030)	超硬コーティングインサート Coated Carbide Insert
被削材 Work Material	FC250	
切込深さ Depth of Cut	ap=2mm ae=44mm	
突出し長さ Overhang Length	300mm (5D)	
切削油剤 Coolant	なし(エアブロー) Air Blow	
使用機械 Machine	横形マシニングセンタ(BT50) Horizontal Machining Center	

L/D=5の突出しの長い加工において、他社品と比較して高効率加工が可能となった。また他社品は低回転領域で、切れ味不足によりワークへの食付き性が悪くびり振動が発生(グラフ斜線部分)。切れ味に優れるPSTWは低回転領域でも安定した加工が可能であった。

In this test, the PSTW achieved higher efficiency versus the competitor tool in the processing of long overhang length of L/D=5. Furthermore, due to the lack of sharpness in the cutting edge, the competitor tool had poor contact with the workpiece in the low-speed machining range, resulting in chattering (lined area on graph). With an ultra sharp cutting edge, the PSTW was able to achieve stable performance even in the low-speed cutting range.

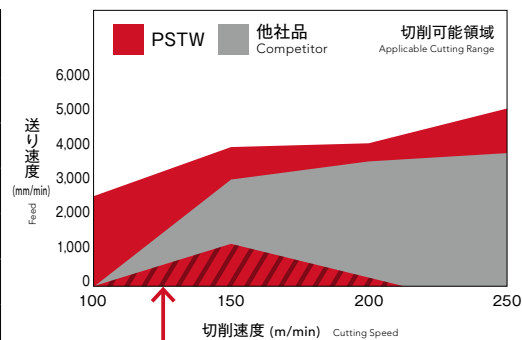

低回転領域 Low-Speed Range
他社品ではびり振動発生
Chattering occurred with the competitor tool

» Phoenix PMD

多機能カッタシリーズ
Multi-function Cutter Series

Phoenix Multi-function Cutter Series



■一本で様々な加工形態に対応 Supports a wide range of applications with a single tool

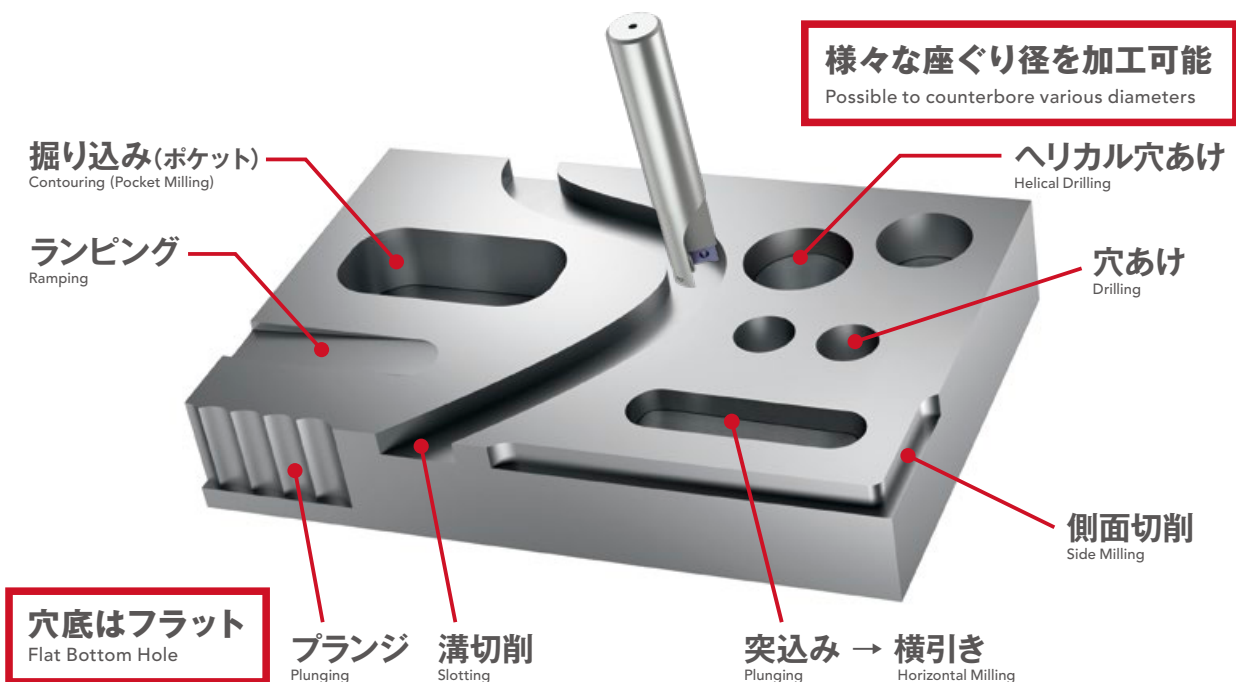

2種類のインサートを使用することで「突込み→横引き」の連続加工が可能

Two types of inserts are used to enable continuous cutting - from plunging to horizontal milling

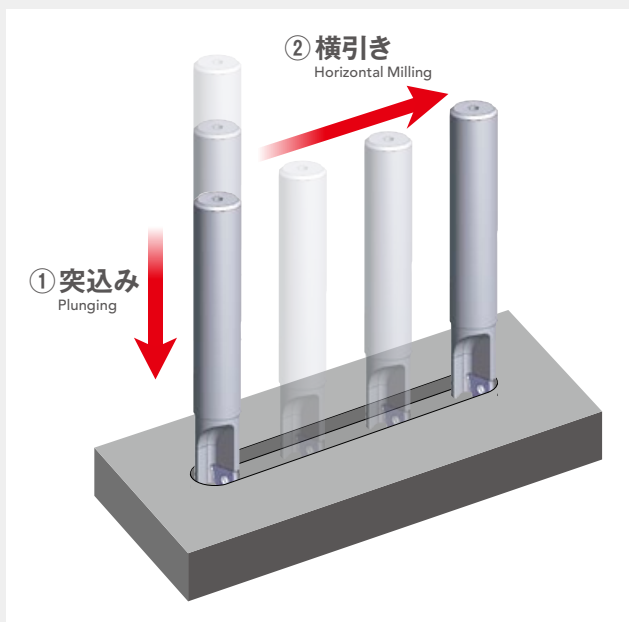

底刃用インサート

Inserts for Drilling and Plunging Edge

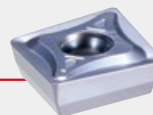

優れた切りくず分断性で
トラブルの無い安定加工。
座ぐりカッタPZAGと
同じインサートを採用。
Superior chip breaking capability
for stable machining without chip
trouble. Uses the same insert as the
PZAG counterboring cutter.

外周刃用インサート

Insert for Peripheral Cutting Edge



高い剛性とシャープな切れ刃で
びびらず安定した長寿命。
肩削りカッタPSEと
同じインサートを採用。
High rigidity and sharp cutting edge
ensure stable long tool life without
chattering. Uses the same insert as
the PSE shoulder cutter.

■穴底フラット Flat Bottom Hole

使用工具 Tool	PMD11R025SS25-1S (φ25×1刃)		他社品A (φ25×2刃) Competitor	他社品B (φ25×2刃) Competitor
使用インサート (材種) Insert (grade)	底刃: ZPNT130508EN (XP8030) Center Insert	外周刃: ZDKT11T308SR-GM (XC3030) Peripheral Insert	-	-
切削方法 Milling Method	ヘリカル穴あけ加工φ32 Helical Drilling			
被削材 Work Material	S50C			
切削速度 Cutting Speed	150m/min (1,910min ⁻¹)			
送り速度 Feed	84mm/min (0.2mm/t)	84mm/min (0.1mm/t)		
切込深さ Depth of Cut	ap=20mm			
加工角度 Processing Angle	2.8° (ヘリカルピッチ1mm) Helical Pitch			
切削油剤 Coolant	なし(エアブロー) None (Air Blow)			
使用機械 Machine	立形マシニングセンタ(BT40) Vertical Machining Center			

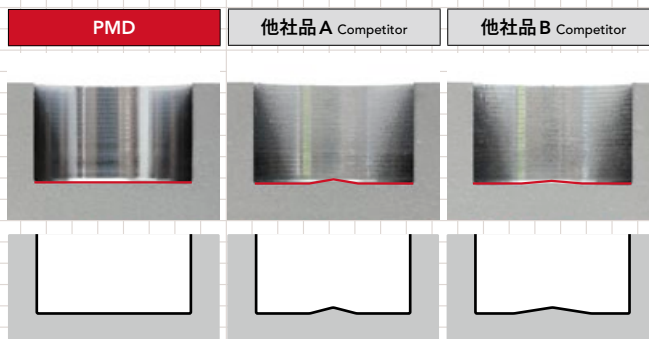

穴底形状イメージ
Bottom Hole Shape Comparison

■穴加工で高い切りくず分断性 Superior chip breaking capability during drilling and plunging



切れ刃に対して大きく盛り上がった
マッスルブレイカで抜群の切りくず分断性を実現
Excellent chip breaking capability with the enhanced muscle breaker

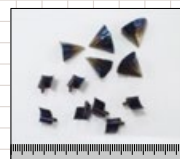

φ25
穴加工(ノンステップ加工)
被削材: S50C
φ25 hole processing (non-step drilling)
Work material: S50C

■加工用途に合わせたインサートバリエーション

Insert lineup corresponding to individual application needs

被削材 Work Material	底刃用インサート材種 Insert Grade for Drilling and Plunging Edge	外周刃用インサート材種 Insert Grades for Peripheral Cutting Edge	
鋼 Steel P	XP8030	WETなら XP3035	DRYなら XC3030
ステンレス鋼 Stainless Steel M		XP2040	
鋳鉄 Cast Iron K		WETなら XP3025	DRYなら XC1015
非鉄金属 Non-ferrous N		CK010	
耐熱鋼 Heat-resistant Alloy S		XC5040	
高硬度材 High Hardness Material H		XP6015	

Phoenix

多機能カッタ ストレートシャンクタイプ

Multi-function Cutter with Straight Shank

PMD SS



カッタ切込角
Cutting Angle

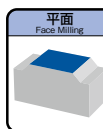

平面
Face Milling

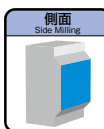

側面
Side Milling

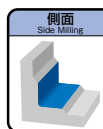

側面
Side Milling



溝
Slotting

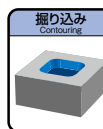

掘り込み
Contouring



座ぐり
Counter Sinking

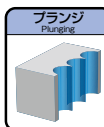

フランジ
Plunging

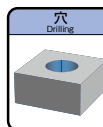

穴
Drilling



ヘリカル穴あけ
Helical Drilling

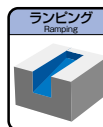

ランピング
Ramping

Specification

形状寸法表 Specification

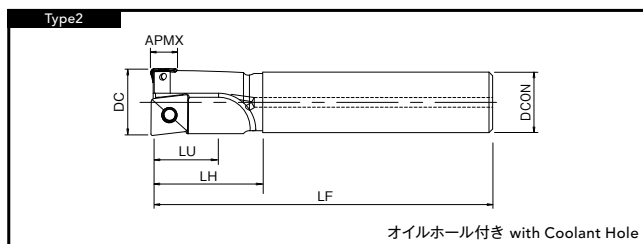
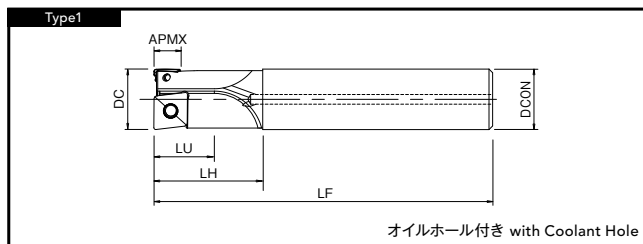

単位:mm Unit:mm

ソールNo. EDP No.	呼び Designation	外径 DC	溝数 NOF	刃数 ZEPF	シャンク径 DCON	全長 LF	首下長 LH	有効溝長 LU	刃長 APMX	重量 (kg)	適用インサート Applicable Inserts		形状 タイプ Type	標準価格 (Yen)
											底刃 Center Insert	外周刃 Peripheral Insert		
7803419	PMD07R016SS16-1S	16	2	1	16	100	30	16	6	0.12	① ZPNT080304EN	① ZDKT070304...	1	25,100
7803420	PMD07R016SS16-1L	16			150	50	16	0.18						
7803421	PMD07R018SS16-1S	★18			16	100	30				18		0.13	25,900
7803422	PMD07R018SS16-1L	★18			16	150	30	18			0.19			
7803410	PMD11R020SS20-1S	20			20	130	35	20	10	0.3		③ ZPNT100408EN	② ZDKT11T308...	1
7803413	PMD11R020SS20-1L	20			185	60	20	0.4			30,200			
7803411	PMD11R025SS25-1S	25			25	140	45					25		0.45
7803414	PMD11R025SS25-1L	25			25	220	75	25			0.75	33,200		
7803412	PMD11R032SS32-1S	32			32	150	50	28						0.8
7803415	PMD11R032SS32-1L	32			32	230	90	28	1.3	36,100				

★刃太タイプ

Reduced Shank Type

★ PMD 刃太タイプ Reduced Shank Type

例
Example

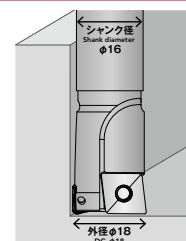

- 刃太タイプは、シャンク径よりも工具外径の方が大きいいため、金型部品などの深い立ち壁加工やポケット加工に最適です

The outer diameter of the reduced shank type is larger than the shank diameter, making it highly effective in the processing of die and mold applications that require vertical wall milling or pocketing.

Phoenix

多機能カッタ ねじ込みタイプ

Multi-function Cutter with Screw Fit Type

PMD SF

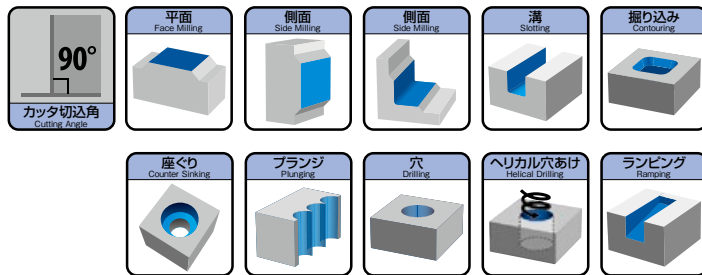

Specification

■形状寸法表 Specification

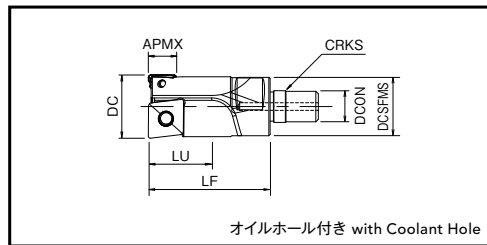

オイルホール付き with Coolant Hole



■ねじ込みタイプ Screw Fit Type

単位:mm Unit:mm

ツールNo. EDP No.	呼び Designation	外径 DC	溝数 NOF	刃数 ZEFP	取付け 径 DCON	ねじ サイズ CRKS	スパナ サイズ Spanner Size	全長 LF	首径 DN	有効 溝長 LU	刃長 APMX	端面径 DCSFMS	重量 (kg)	適用インサート Applicable Inserts			適用シャンク ホルダタイプ Applicable Shank	標準価格 (円)
														底刃 Center Insert	外周刃 Peripheral Insert			
7803423	PMD07R016SF8-1	16			8.5	M 8	10	40	15.4	16	6	14.5	0.07	① ZPNT080304EN	① ZDKT070304...	③	25,100	
7803424	PMD07R018SF8-1	★18			8.5	M 8	10	40	17	18		14.5	0.08	② ZPNT090404EN				
7803416	PMD11R020SF10-1	20	2	1	10.5	M10	14	48	19	20	10	18	0.1	③ ZPNT100408EN	② ZDKT11T308...	④	27,500	
7803417	PMD11R025SF12-1	25			12.5	M12	17	48	23	25		23	0.15	④ ZPNT130508EN				
7803418	PMD11R032SF16-1	32			17	M16	22	58	30	28		28	0.3	⑤ ZPNT170608EN				

シャンクホルダについてはp.242～p.244をご覧ください。
See p.242-p.244 for shank holders.

★ 刃太タイプ
Reduced Shank Type

★ PMD刃太タイプ Reduced Shank Type

例
Example

- 刃太タイプは、シャンク径よりも工具外径の方が大きいため、金型部品などの深い立ち壁加工やポケット加工に最適です
- The outer diameter of the reduced shank type is larger than the shank diameter, making it highly effective in the processing of die and mold applications that require vertical wall milling or pocketing.

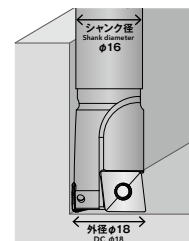

在庫区分は全てC(標準在庫品)となります。 Stock are categorized as C (Standard stock item).

Phoenix

多機能カッタシリーズ

Multi-function Cutter Series

PMDインサート

Inserts

Inserts

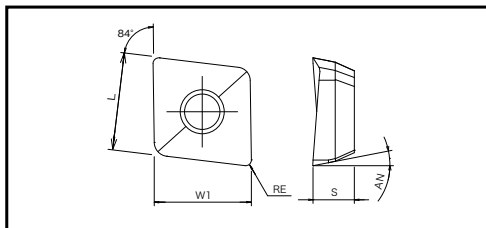

■底刃用インサート Inserts for Drilling and Plunging Edge

単位:mm Unit:mm

呼び Designation	切れ刃数 No. of Cutting Edges	インサート寸法 Insert Size				適用ボディ Applicable Body	コーティング材種 Carbide Coated Materials	標準価格 (Yen)
		L×W1	厚さ S	逃げ角 AN	RE		XP8030	
① ZPNT080304EN	2	8.85×8.85	3.92	11°	0.4	φ16	7814105	1,920
② ZPNT090404EN	2	9.94×9.94	4.65	11°	0.4	φ18	7814106	1,930
③ ZPNT100408EN	2	10.95×10.95	4.65	11°	0.8	φ20	7814108	2,030
④ ZPNT130508EN	2	13.92×13.92	5.46	11°	0.8	φ25	7814110	2,350
⑤ ZPNT170608EN	2	17.85×17.85	6.31	11°	0.8	φ32	7814111	2,470

※ PMDの適応インサートは上記掲載インサートのみです。
 ※ Only the inserts listed above are applicable for PMD.

底刃用インサートは座ぐりカッタ PZAG・インデキサブルフラットドリル PDZと共通使用できます

(一部インサートを除く。詳細は各製品ページをご確認ください。)
 Inserts for drilling and plunging edge are applicable for the PZAG counterboring cutter and PDZ indexable flat drill.
 (Some inserts are excluded. Please refer to each product section for details.)

より高効率な座ぐり加工をお求めの方にはPZAGを推奨します。
 PZAG is recommended for those seeking even greater counterboring efficiency.

■座ぐりカッタPZAG Counterboring Cutter PZAG (p.71)



■インデキサブルフラットドリルPDZ Indexable Flat Drill PDZ (p.59)



Inserts

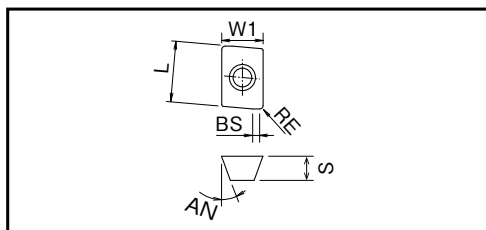

■外周刃用インサート Inserts for Peripheral Cutting Edge

単位:mm Unit:mm

呼び Designation	切れ刃数 No. of Cutting Edges	インサート寸法 Insert Size					コーティング材種 Grade of Coated Materials											標準価格 (Yen)		
		L×W1	厚さ S	逃げ角 AN	RE	ざらい刃 (副切れ刃) BS	超硬 Uncoated	CK010	XC3020	XP3025	XC3030	XP3035	XP2025	XP2040	XC1015	XC5035	XC5040		XP6015	
① ZDKT070304FR-NM	2	8.2×4	2.54	15°	0.4	0.9	7811113													1,210
	ZDKT070304SR-GL	2	8.2×4	2.54	15°	0.4	0.9				7825127	7814123	7826121	7813117						1,210
	ZDKT070304SR-GM	2	8.2×4	2.54	15°	0.4	0.9				7825128	7814124		7813118	7812114					1,210
② ZDKT11T308FR-NM	2	11×6.8	3.8	15°	0.8	1.4	7811023													2,030
	ZDKT11T308SR-GL	2	11×6.8	3.8	15°	0.8	1.4		7827026	7828026	7825026	7814026	7826026	7813026						1,590
	ZDKT11T308SR-GM	2	11×6.8	3.8	15°	0.8	1.4		7827032	7828032	7825032	7814032	7826032	7813032						1,590
	ZDKT11T308SR-GR	2	11×6.8	3.8	15°	0.8	1.4		7827033	7828033	7825033	7814033		7813033	7812033					1,590
	ZDKT11T308SR-HR	2	11×6.8	3.8	15°	0.8	1.4												7824035	2,030
ZDKT11T308ER-SM	2	11×6.8	3.8	15°	0.8	1.4										7815031	7816031			3,180

※ PMDの適応インサートは上記掲載インサートのみです。
 ※ Only the inserts listed above are applicable for PMD.

外周刃用インサートは肩削りカッタシリーズPSEと 共通使用できます

Inserts for the peripheral cutting edge are applicable for the PSE shoulder milling cutter.

豊富なバリエーションで幅広い加工に対応可能な肩削りカッタです
 A wide variety of shoulder cutters that can be used for various milling operations.

■肩削りカッタシリーズPSE Shoulder Cutter Series PSE (p.103)



Accessories

■ 部品 Accessories

		ツールNo. EDP No.	呼び Designation	適用インサート Applicable Inserts		適用ボディ Applicable Body	推奨締め付けトルク Recommended Tightening Torque
 クランプねじ Clamping Screw	底刃用 for Drilling and Plunging Edge	7808135	FS30570P (Torx 9IP)	①	ZPNT08...	PMD07R016...	2.2 N·m
				②	ZPNT09...	PMD07R018...	
		7808137	FS35586P (Torx 15IP)	③	ZPNT10...	PMD11R020...	3.2 N·m
	外周刃用 for Peripheral Cutting Edge	7808114	FS45510P (Torx 20IP)	④	ZPNT13...	PMD11R025...	5.0 N·m
				⑤	ZPNT17...	PMD11R032...	
		7808099	FS18637P (Torx 6IP)	①	ZDKT07...	PMD07R016... PMD07R018...	0.5 N·m
7808107	FS25656P (Torx 8IP)	②	ZDKT11...	PMD11R020... PMD11R025... PMD11R032...	1.6 N·m		

		ツールNo. EDP No.	呼び Designation	適用インサート Applicable Inserts		適用ボディ Applicable Body	標準価格 (Yen)
 レンチ Wrench	底刃用 for Drilling and Plunging Edge	7808226	9IP-D (Torx 9IP)	①	ZPNT08...	PMD07R016...	1,600
				②	ZPNT09...	PMD07R018...	
		7808228	15IP-D (Torx 15IP)	③	ZPNT10...	PMD11R020...	1,820
	外周刃用 for Peripheral Cutting Edge	7808229	20IP-D (Torx 20IP)	④	ZPNT13...	PMD11R025...	1,930
				⑤	ZPNT17...	PMD11R032...	
		7808223	6IP-D (Torx 6IP)	①	ZDKT07...	PMD07R016... PMD07R018...	1,600
7808225	8IP-D (Torx 8IP)	②	ZDKT11...	PMD11R020... PMD11R025... PMD11R032...	1,560		

レンチは別途ご購入下さい。 The wrenches are sold separately from the cutters.

Phoenix

多機能カッタシリーズ

Multi-function Cutter Series

PMD

■被削材別推奨材質

Recommended Materials by Insert Type

◎第一推奨材質 Best
○第二推奨材質 Good

インサート材種 Insert Grades		ブレーカ Insert Breaker	切削油剤 Coolant	P	M	K	N	S	H
底刃用 インサート Center Insert	XP8030	-	有 Wet	◎	◎	○	○	○	○
	CK010	NM	有 Wet				◎		
外周刃用 インサート Peripheral Insert	XC3020	GL GM GR	無 Dry	◎		○			
	XP3025	GL GM GR	有 Wet	◎		○			
	XC3030	GL GM GR	無 Dry	◎		○			
	XP3035	GL GM	無 Dry	◎	○	○			
			有 Wet	◎	○	○			
外周刃用 インサート Peripheral Insert	XP2025	GL GM	有 Wet	○	◎			○	
	XP2040	GL GM	無 Dry	○	○				○
			有 Wet	○	◎			○	
	XC1015	GM GR	無 Dry			◎			
	XC5035	SM	無 Dry		◎				
			有 Wet		○			○	
XC5040	SM	有 Wet		○			◎		
XP6015	HR	無 Dry	○		○			◎	

NM:アルミニウム合金用 GL:軽切削用 GM:中切削用 GR:重切削用 HR:高硬度鋼用 SM:耐熱合金用
NM:Aluminum Alloy GL:Light Cutting GM:Middle Cutting GR:Heavy Cutting HR:High Hardened Steel
SM:Heat Resistance Alloy

Cutting Conditions

■切削条件基準表 Cutting Conditions

側面・溝加工 Side Milling・Slot Milling 横引き加工時は1枚刃で計算下さい。 For horizontal milling, calculate by per tooth.

被削材 Work Material	引張強さ・硬さ Tensile Strength・Hardness	側面加工 Side Milling				溝加工 Slot Milling				
		φ16, 18		φ20, 25, 32		φ16, 18		φ20, 25, 32		
		切削深さap:6mm、 切削幅ae:0.15D	切削速度 Vc (m/min) Cutting Speed	1刃当りの送り量 fz (mm/t) Feed per Tooth	切削深さap:10mm、 切削幅ae:0.2D	切削速度 Vc (m/min) Cutting Speed	1刃当りの送り量 fz (mm/t) Feed per Tooth	切削深さap:2mm、 切削幅ae:1.0D	切削速度 Vc (m/min) Cutting Speed	1刃当りの送り量 fz (mm/t) Feed per Tooth
P 軟鋼、低炭素鋼 Mild Steel, Carbon Steel (SS400, S10C)	~180HB	180 (100~250)	0.15 (0.1~0.2)	180 (100~250)	0.25 (0.2~0.5)	180 (100~250)	0.07 (0.05~0.09)	180 (100~250)	0.12 (0.05~0.2)	
	炭素鋼、合金鋼 Carbon Steel, Alloy Steel (S50C, SCM440)	~280HB	180 (100~250)	0.15 (0.1~0.2)	180 (100~250)	0.2 (0.15~0.4)	180 (100~250)	0.07 (0.05~0.09)	180 (100~250)	0.11 (0.05~0.2)
		ダイス鋼 Die Steel (SKD11, SKD61)	~280HB	150 (80~200)	0.15 (0.1~0.2)	150 (80~200)	0.2 (0.15~0.4)	150 (80~200)	0.06 (0.05~0.08)	150 (80~200)
M ステンレス鋼(乾式) Stainless Steel (Dry) (SUS304, SUS420)	~250HB	150 (80~200)	0.12 (0.1~0.2)	150 (80~200)	0.18 (0.15~0.4)	150 (80~200)	0.06 (0.05~0.08)	150 (80~200)	0.1 (0.05~0.18)	
	ステンレス鋼(湿式) Stainless Steel (Wet) (SUS304, SUS420)	~250HB	80 (60~120)	0.12 (0.1~0.2)	80 (60~120)	0.18 (0.15~0.4)	80 (60~120)	0.06 (0.05~0.08)	80 (60~120)	0.1 (0.05~0.18)
K 鋳鉄 Cast Iron (FC250)	~350N/mm ²	180 (100~300)	0.18 (0.12~0.25)	180 (100~300)	0.25 (0.15~0.5)	180 (100~300)	0.1 (0.05~0.12)	180 (100~300)	0.12 (0.05~0.2)	
	ダクタイル鋳鉄 Ductile Cast Iron (FCD400)	~800N/mm ²	180 (100~250)	0.15 (0.1~0.2)	180 (100~250)	0.15 (0.1~0.4)	180 (100~250)	0.1 (0.05~0.12)	180 (100~250)	0.12 (0.05~0.2)
N アルミニウム合金 Aluminum Alloy	~13%Si	300 (200~1,500)	0.2 (0.15~0.25)	300 (200~1,500)	0.3 (0.2~0.5)	300 (200~1,500)	0.12 (0.1~0.15)	300 (200~1,500)	0.15 (0.1~0.25)	
S 超耐熱合金(湿式) Superalloy (Wet) (Inconel 718)	-	35 (25~60)	0.1 (0.08~0.15)	35 (25~60)	0.15 (0.1~0.3)	35 (25~60)	0.06 (0.05~0.15)	35 (25~60)	0.1 (0.05~0.15)	
	チタン合金(湿式) Titanium Alloy (Wet) (Ti-6Al-4V)	-	40 (30~120)	0.1 (0.08~0.15)	40 (30~120)	0.18 (0.1~0.35)	40 (30~120)	0.06 (0.04~0.07)	40 (30~120)	0.1 (0.08~0.25)
H ブリハードン鋼 Pre-hardened Steel (NAK80)	40~43HRC	100 (40~150)	0.1 (0.08~0.15)	100 (40~150)	0.18 (0.1~0.3)	100 (40~150)	0.07 (0.05~0.08)	90 (40~150)	0.1 (0.08~0.2)	
	ダイカスト用鋼 Steel for Die Casting (DAC-MAGIC, DH31)	43~48HRC	80 (40~120)	0.1 (0.08~0.15)	80 (40~120)	0.12 (0.08~0.2)	80 (40~120)	0.06 (0.04~0.08)	70 (40~120)	0.08 (0.06~0.15)
		調質鋼 Hardened Steel (SKD11)	50~55HRC	60 (40~90)	0.08 (0.06~0.1)	60 (40~90)	0.1 (0.05~0.2)	60 (40~90)	0.05 (0.04~0.06)	50 (40~90)

・上記条件表はショートシャンクタイプにおける推奨値となります。
ロングシャンクタイプは、切削速度を上記条件表の80%でご使用下さい。

- この切削条件基準表は、水溶性切削油剤を使用する場合のものです。
- この切削条件基準表は、実切削速度における一般的な値を示したものです。
加工環境に合わせて適宜調整して下さい。
- インサートの装着に際しては、傷や汚れを取り除いた状態でしっかりと取り付けて下さい。
- 被削材の保持はしっかりと行い、変形、たわみ、振動が起こらない状態にして下さい。

・ Above recommended speed is for short shank type.
For long shank type, use the following cutting condition: cutting speed = 80% of the above settings.

- The indicated speeds and feeds are for milling with water-soluble coolant.
- The above cutting conditions are to be used as general guidelines. Adjustments may be necessary depending on actual cutting condition.
- Inserts should be attached to the holder tightly in a very neat condition.
- Fasten the work material to reduce the possibility of work deformation, deflection of machined surface, or vibration.

Cutting Conditions

穴加工 Drilling 座ぐり加工・ブランチ加工共通 For both counterboring and plunge milling

被削材 Work Material	引張強さ・硬さ Tensile Strength・Hardness	切削速度 Vc (m/min) Cutting Speed	送り量 f(mm/rev) Feed Rate					
			φ16	φ18	φ20	φ25	φ32	
P 軟鋼、低炭素鋼 Mild Steel, Carbon Steel (SS400, S10C)	~180HB	160(100~200)	0.06(0.04~0.07)	0.06(0.04~0.07)	0.07(0.05~0.08)	0.08(0.06~0.1)	0.1(0.08~0.12)	
	炭素鋼、合金鋼 Carbon Steel, Alloy Steel (S50C, SCM440)	~280HB	150(100~200)	0.06(0.04~0.07)	0.06(0.04~0.07)	0.07(0.05~0.08)	0.08(0.06~0.1)	0.1(0.08~0.12)
	ダイス鋼 Die Steel (SKD11, SKD61)	~280HB	120(80~180)	0.06(0.04~0.07)	0.06(0.04~0.07)	0.07(0.05~0.08)	0.08(0.06~0.1)	0.1(0.08~0.12)
M ステンレス鋼 Stainless Steel (SUS304, SUS420)	~250HB	130(80~180)	0.06(0.04~0.07)	0.06(0.04~0.07)	0.07(0.05~0.08)	0.08(0.06~0.1)	0.1(0.08~0.12)	
K 鋳鉄 Cast Iron (FC250)	~350N/mm ²	200(150~180)	0.06(0.04~0.07)	0.06(0.04~0.07)	0.07(0.05~0.08)	0.08(0.06~0.1)	0.1(0.08~0.12)	
	ダクタイル鋳鉄 Ductile Cast Iron (FCD400)	~800N/mm ²	160(100~220)	0.06(0.04~0.07)	0.06(0.04~0.07)	0.07(0.05~0.08)	0.08(0.06~0.1)	0.1(0.08~0.12)
N アルミニウム合金 Aluminum Alloy	~13%Si	200(100~800)	0.06(0.04~0.07)	0.06(0.04~0.07)	0.07(0.05~0.08)	0.08(0.06~0.1)	0.1(0.08~0.12)	
S 超耐熱合金(湿式) Superalloy (Wet) (Inconel718)	-	50(30~60)	0.06(0.04~0.07)	0.06(0.04~0.07)	0.07(0.05~0.08)	0.08(0.06~0.1)	0.1(0.08~0.12)	
	チタン合金(湿式) Titanium Alloy (Wet) (Ti-6Al-4V)	-	60(30~100)	0.06(0.04~0.07)	0.06(0.04~0.07)	0.07(0.05~0.08)	0.08(0.06~0.1)	0.1(0.08~0.12)
H ブリハードン鋼 Pre-hardened Steel (NAK80)	40~43HRC	100(60~120)	0.06(0.04~0.07)	0.06(0.04~0.07)	0.07(0.05~0.08)	0.08(0.06~0.1)	0.1(0.08~0.12)	
	ダイカスト用鋼 Steel for Die Casting (DAC-MAGIC, DH31)	43~48HRC	80(40~100)	0.06(0.04~0.07)	0.06(0.04~0.07)	0.07(0.05~0.08)	0.08(0.06~0.1)	0.1(0.08~0.12)
	調質鋼 Hardened Steel (SKD11)	50~55HRC	60(40~80)	0.06(0.04~0.07)	0.06(0.04~0.07)	0.07(0.05~0.08)	0.08(0.06~0.1)	0.1(0.08~0.12)

- ・上記条件表はショートシャンクタイプにおける推奨値となります。
ロングシャンクタイプは、切削速度を上記条件表の80%でご使用下さい。
- この切削条件基準表は、水溶性切削油剤を使用する場合のものです。
 - この切削条件基準表は、実切削速度における一般的な値を示したものです。
加工環境に合わせて適宜調整して下さい。
 - インサートの装着に際しては、傷や汚れを取り除いた状態でしっかりと取り付けて下さい。
 - 被削材の保持はしっかりと行い、変形、たわみ、振動が起らない状態にして下さい。

- ・ Above recommended speed is for short shank type.
For long shank type, use the following cutting condition: cutting speed = 80% of the above settings.
- The indicated speeds and feeds are for milling with water-soluble coolant.
 - The above cutting conditions are to be used as general guidelines. Adjustments may be necessary depending on actual cutting condition.
 - Inserts should be attached to the holder tightly in a very neat condition.
 - Fasten the work material to reduce the possibility of work deformation, deflection of machined surface, or vibration.

■ランピング・ヘリカル穴あけ加工時の最大傾斜角は3°以下に設定下さい。

Set the maximum processing angle during ramping and helical drilling operations to less than 3°.

ランピング Ramping

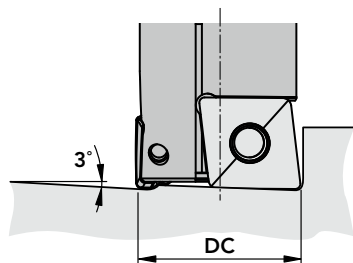

ヘリカル穴あけ Helical Drilling

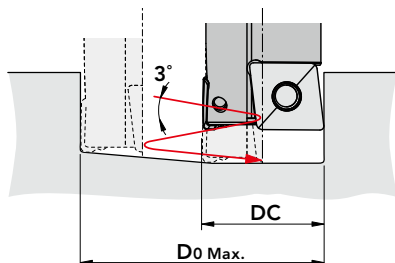

単位:mm Unit:mm

外径 (DC)	ヘリカル穴あけ 最大径 (D0 Max.)
16	30
18	34
20	37
25	47
32	61

Cutting Data

加工データ Cutting Data

突込み → 横引き加工 Plunging → Horizontal Milling

使用工具 Tool	PMD11R025SS25-1S (φ25×1刃)	
使用インサート(材種) Insert (grade)	底刃 Center Insert : ZPNT130508EN (XP8030) 外周刃 Peripheral Insert : ZDKT11T308SR-GM (XC3030)	
切削方法 Milling Method	突込み Plunging	横引き加工 Horizontal Milling
被削材 Work Material	S50C	
切削速度 Cutting Speed	100m/min (1,274min ⁻¹)	
送り速度 Feed	102mm/min (0.08mm/rev)	204mm/min (0.16mm/t)
切込深さ Depth of Cut	ap=7mm ae=25mm	
切削油剤 Coolant	なし(エアブロー) None (Air Blow)	
使用機械 Machine	立形マシニングセンタ (BT40) Vertical Machining Center	

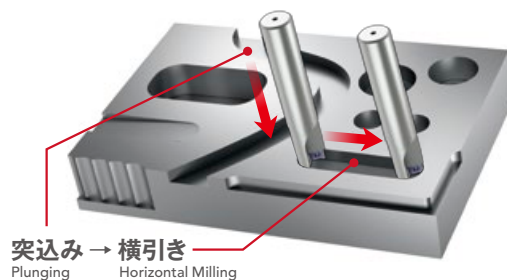

突込み → 横引き
Plunging → Horizontal Milling



びびりの無い良好な加工面を得られた。
Excellent milling surface finish without chattering.

溝加工・側面加工 Slotting · Side Milling

使用工具 Tool	PMD07R016SS16-1S (φ16×1刃)	
使用インサート(材種) Insert (grade)	底刃 Center Insert : ZPNT080304EN (XP8030) 外周刃 Peripheral Insert : ZDKT070304SR-GM (XC3030)	
切削方法 Milling Method	溝加工 Slotting	側面加工 Side Milling
被削材 Work Material	S50C	
切削速度 Cutting Speed	150m/min (2,986min ⁻¹)	
送り速度 Feed	210mm/min (0.07mm/t)	
切込深さ Depth of Cut	ap=3mm ae=16mm	ap=4mm ae=2mm
切削油剤 Coolant	なし(エアブロー) None (Air Blow)	
使用機械 Machine	立形マシニングセンタ (BT40) Vertical Machining Center	

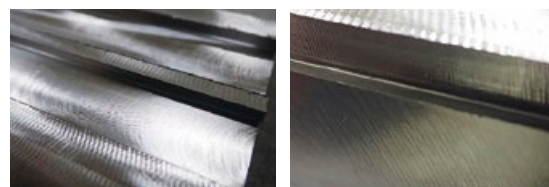
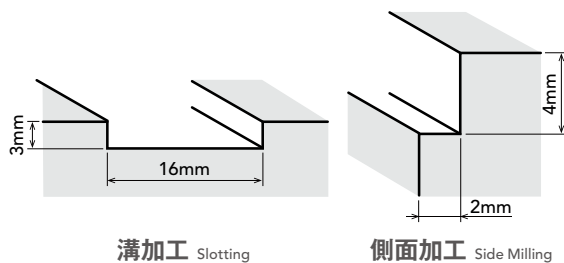

Cutting Data

■加工データ Cutting Data

ヘリカル穴あけ加工・ランピング加工 Helical Drilling・Ramping

使用工具 Tool	PMD11R025SS25-1S (φ25×1刃)	
使用インサート(材種) Insert (grade)	底刃 Center Insert : ZPNT130508EN (XP8030)	外周刃 Peripheral Insert : ZDKT11T308SR-GM (XC3030)
切削方法 Milling Method	ヘリカル穴あけ加工 φ40 Helical Drilling	ランピング加工 Ramping
加工角度 Processing Angle	2.5° (ヘリカルピッチ2mm) Helical Pitch	3°
被削材 Work Material	S50C	
切削速度 Cutting Speed	150m/min (1,910min ⁻¹)	
送り速度 Feed	107mm/min (0.15mm/t)	287mm/min (0.15mm/t)
切込深さ Depth of Cut	ap=25mm	ap=7mm
切削油剤 Coolant	なし(エアブロー) None (Air Blow)	
使用機械 Machine	立形マシニングセンタ(BT40) Vertical Machining Center	



穴口元はバリ無く、底部中心部のへそ残りも無く加工可能。

No burrs at the hole entry and no leftover material in the center of hole after processing.

黒皮部の座ぐり加工も高効率に加工可能 High-efficiency counterboring of the casted surface is made possible

使用工具 Tool	PMD11R025SS25-1S (φ25×1刃)	他社品 (φ25×2刃) Competitor
使用インサート(材種) Insert (grade)	底刃 : ZPNT130508EN (XP8030) Center Insert 外周刃 : ZDKT11T308-SR (XC1015) Peripheral Insert	-
被削材 Work Material	FC250	
切削速度 Cutting Speed	150m/min (1,909min ⁻¹)	78m/min (1,000min ⁻¹)
送り速度 Feed	286mm/min (0.15mm/rev)	100mm/min (0.1mm/rev)
座ぐり径 Counterboring Dia.	φ25	
切込深さ Depth of Cut	5mm	
切削油剤 Coolant	なし(エアブロー) None (Air Blow)	
使用機械 Machine	横形マシニングセンタ(BT50) Horizontal Machining Center	

	加工時間(秒/穴) Cutting Time (sec./hole)			
	1	2	3	4
PMD	1	2	3	4
他社品 Competitor	[Visual representation of a much longer bar]			



黒皮部の不安定な加工面であっても、PMDはフラットかつ良好な加工面が得られ、加工時間も短縮した。

The PMD is able to achieve excellent milling surface finish and reduce processing time even on unstable rough casted surface.

穴加工からの繰り広げで加工時間短縮 Processing time reduction by continuous operation from drilling to contouring

使用工具 Tool	PMD11R025SS25-1S (φ25×1刃)	従来品 超硬エンドミル(φ20×4刃) Conventional carbide end mill
使用インサート (材質) Insert (grade)	底刃 : ZPNT130508EN (XP8030) Center Insert 外周刃 : ZDKT11T308-GM (XP3035) Peripheral Insert	-
被削材 Work Material	FCV410	
切削油剤 Coolant	不水溶性切削油材(内部給油) Non-water-soluble (Internal)	
使用機械 Machine	立形マシニングセンタ(BT40) Vertical Machining Center	

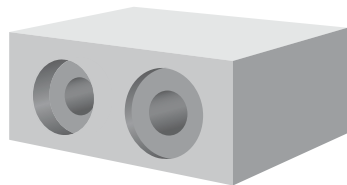

座ぐり径 Counterboring Dia.	φ31.8		φ34.8		φ40.8				
加工形状 Processing Shape									
使用工具 Tool	PMD (φ25×1刃)		従来品 (φ20×4刃) Conventional		PMD (φ25×1刃)		従来品 (φ20×4刃) Conventional		
切削方法 Milling Method	穴あけ加工 Drilling	繰り広げ加工 (3パス) Contouring	ヘリカル加工 Helical Drilling	穴あけ加工 Drilling	繰り広げ加工 Contouring	ヘリカル加工 Helical Drilling	穴あけ加工 Drilling	繰り広げ加工 Contouring	ヘリカル加工 Helical Drilling
切込深さ Depth of Cut	15mm	ap=5mm ae=3.4mm	ヘリカルピッチ=5mm Helical Pitch	2mm	ap=2mm ae=4.9mm	ヘリカルピッチ=2mm Helical Pitch	2mm	ap=2mm ae=7.9mm	ヘリカルピッチ=2mm Helical Pitch
切削速度 Cutting Speed	157m/min (2,000min ⁻¹)		63m/min (1,000min ⁻¹)	157m/min (2,000min ⁻¹)		63m/min (1,000min ⁻¹)	157m/min (2,000min ⁻¹)		63m/min (1,000min ⁻¹)
送り速度 Feed	350mm/min (0.175mm/rev)	75mm/min (0.175mm/t)	74mm/min (0.05mm/t)	500mm/min (0.25mm/rev)	141mm/min (0.25mm/t)	85mm/min (0.05mm/t)	500mm/min (0.25mm/rev)	194mm/min (0.25mm/t)	102mm/min (0.05mm/t)
実加工時間(計算値) Actual processing time (calculated value)	約80秒 About 80 sec.		約120秒 About 120 sec.	約20秒 About 20 sec.		約66秒 About 66 sec.	約23秒 About 23 sec.		約77秒 About 77 sec.

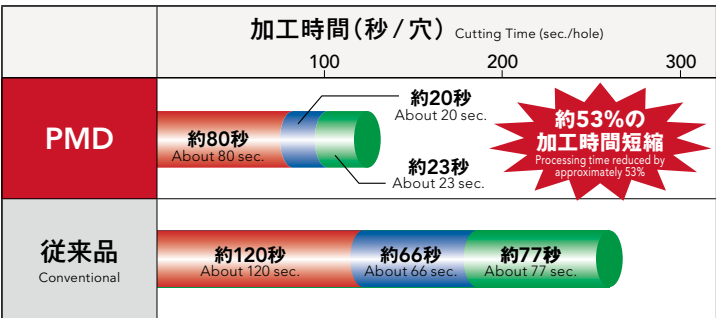

PMDは穴加工から繰り広げることが可能なため加工時間を短縮した。
Processing time is reduced as the PMD is capable of drilling a hole and enlarging it by contouring.

» Phoenix PHC

高送りラジアスカッタシリーズ
High Feed Radius Cutter Series

Phoenix High feed Cutter

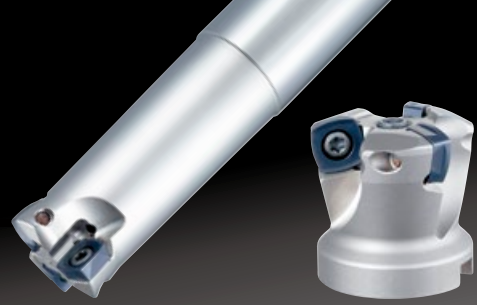

■豊富なバリエーション Broad Product Variations

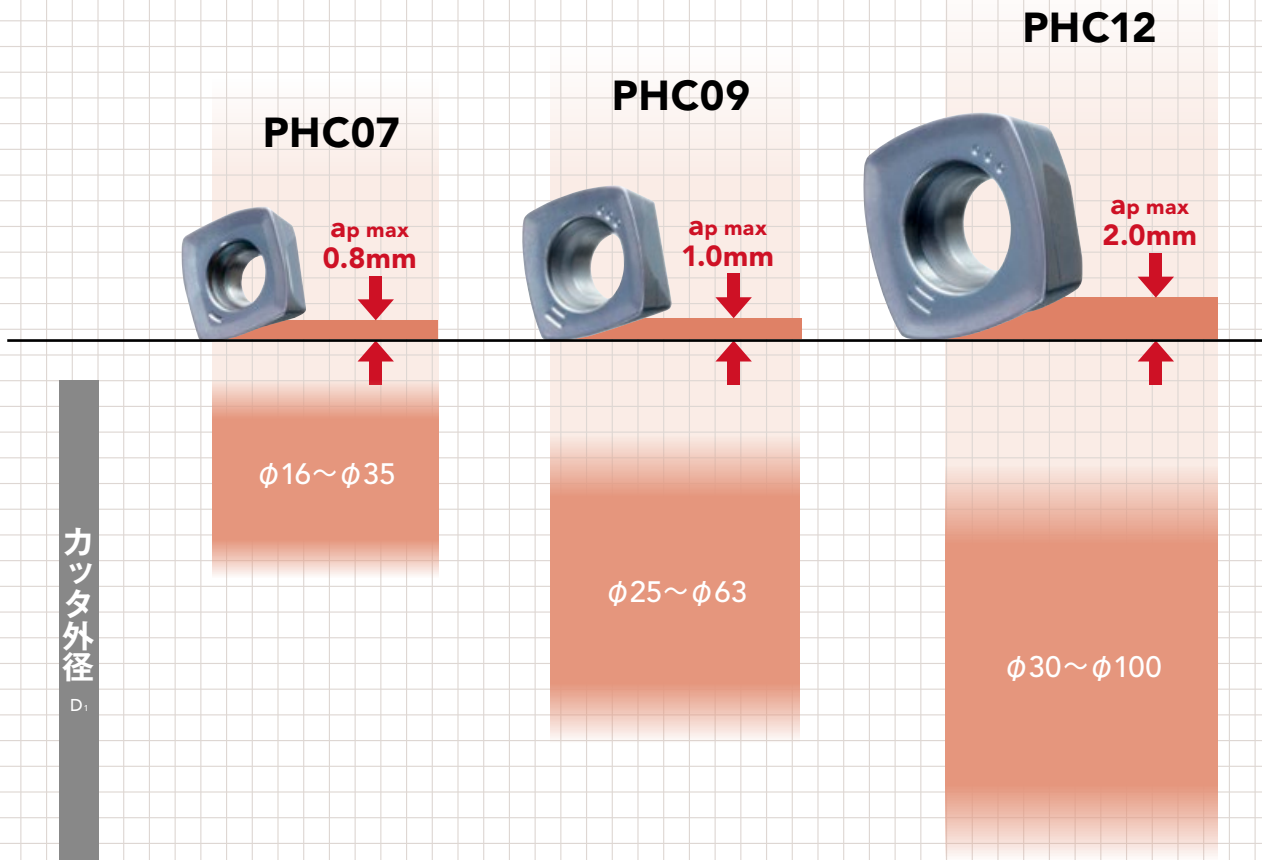

■小径～大径の豊富なバリエーションにより、幅広い加工領域に対応可能

Broad product variations and sizes to accommodate a wide range of machining needs

■荒取り加工における加工時間短縮を実現

Achieves processing time reduction in roughing

■低抵抗仕様により小型マシニングセンタでも高能率加工が可能

High efficiency processing is possible even on small machining centers with low resistance specifications

■荒取り加工に最適な仕様

Ideal configuration for rough milling

- 経済的な4コーナ仕様
Economical 4-corner type
- 刃先剛性を保ちながら、切れ味を重視したブレーカ形状
A breaker shape that enhances cutting performance while ensuring the rigidity of the cutter
- スムーズな切りくず処理により、良好な切りくず排出性
Trouble-free chip evacuation capability with smooth chip control

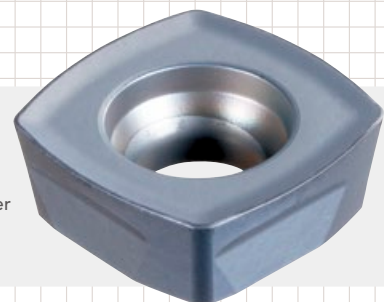

■ 切込み(ae) 変化による切削抵抗 —低抵抗刃形—

Cutting force is reduced by changing the depth of cut (ae)

他社品と比較して低抵抗!

The PHC exhibited a lower cutting force versus the competitor's product!

【使い分け】 Proper tool selection

- ・ PHC09タイプ 多刃仕様による高能率加工 Multiple cutters for highly efficient milling
- ・ PHC12タイプ 断続加工や突出しの長い加工 For milling intermittently or with a long overhang length

■ PHC φ50 切削データ Processing data of PHC φ50

使用工具 Tool	PHC09R050M22-5 (5枚刃)	PHC12R050M22-4 (4枚刃)
使用インサート(材種) Insert (grade)	SDMT09T308SR-GM (XP3035)	SXMT120410SR-GM (XP3035)
被削材 Work Material	S50C	
切削速度 Cutting Speed	180m/min (1,150min ⁻¹)	
送り速度 Feed	5,000mm/min	
切込深さ Depth of Cut	ap=1mm ae=5, 10, 20, 30, 35mm	
突出し長さ Overhang Length	200mm	
切削油剤 Coolant	なし(エアブロー) Air Blow	
使用機械 Machine	立形マシニングセンタ(BT50) Vertical Machining Center	

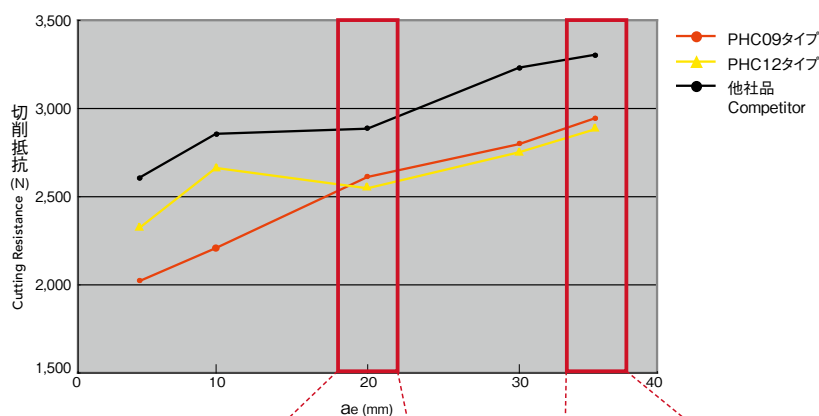

■ 同時接触刃数 Number of flutes making simultaneous contact

切込み(ae)	5mm	10mm	20mm	30mm	35mm
PHC09タイプ	1刃 Flutes	2刃 Flutes	3刃 Flutes	3刃 Flutes	4刃 Flutes
PHC12タイプ	1刃 Flutes	2刃 Flutes	2刃 Flutes	3刃 Flutes	3刃 Flutes

低抵抗な刃先設計によりクロスピッチ仕様のPHC09タイプは切込み(ae)が上がっても切削抵抗が抑えられる。そのため機械負荷・振動を抑えることができ、高能率加工を実現。

Even if the depth of cut (ae) is increased for the PHC09 with close pitch, the design of the cutting edge suppresses the cutting force. This suppresses the load and vibrations imparted on the machine, which enables high efficiency machining.

Phoenix

高送りラジアスカッタ ストレートシャンクタイプ

High Feed Radius Cutter with Straight Shank

PHC SS

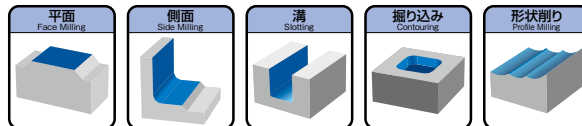

Specification

形状寸法表 Specification

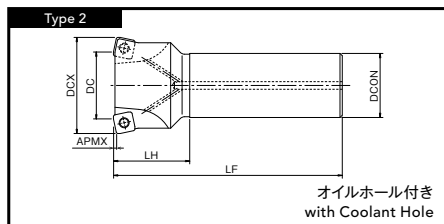
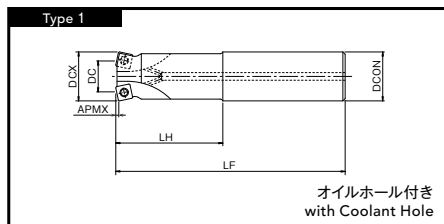

PHC07タイプ PHC07 Type

単位:mm Unit:mm

ツールNo. EDP No.	呼び Designation	カッタ 外径 DCX	外径 DC	刃数 ZFP	シャンク径 DCON	全長 LF	首下長 LH	APMX	重量 (kg)	適用インサート Applicable Inserts	形状 タイプ Type	標準価格 (Yen)
7800750	PHC07R016SS16-2S	16	7.4	2	16	100	30	0.8	0.13	①	1	28,100
7800755	PHC07R016SS16-2L	16	7.4	2	16	150	50	0.8	0.2		1	30,000
7800756	PHC07R017SS16-2L	★ 17	8.4	2	16	150	25	0.8	0.21		2	35,800
7800757	PHC07R018SS16-2L	★ 18	9.4	2	16	150	25	0.8	0.21		2	35,800
7800751	PHC07R020SS20-3S	20	11.4	3	20	130	50	0.8	0.27		1	39,300
7800758	PHC07R020SS20-3L	20	11.4	3	20	160	80	0.8	0.33		1	41,100
7800759	PHC07R021SS20-3L	★ 21	12.4	3	20	160	30	0.8	0.35		2	48,900
7800760	PHC07R022SS20-3L	★ 22	13.4	3	20	160	30	0.8	0.35		2	48,900
7800752	PHC07R025SS25-4S	25	16.4	4	25	140	60	0.8	0.47		1	50,200
7800761	PHC07R025SS25-4L	25	16.4	4	25	200	100	0.8	0.67		1	52,500
7800762	PHC07R026SS25-4L	★ 26	17.4	4	25	200	40	0.8	0.67		2	62,300
7800763	PHC07R028SS25-4L	★ 28	19.4	4	25	200	40	0.8	0.67		2	62,300
7800753	PHC07R030SS32-4S	30	21.4	4	32	150	70	0.8	0.79		1	57,000
7800764	PHC07R030SS32-4L	30	21.4	4	32	200	120	0.8	1.05		1	64,200
7800754	PHC07R032SS32-5S	32	23.4	5	32	150	70	0.8	0.83		1	62,600
7800765	PHC07R032SS32-5L	32	23.4	5	32	200	120	0.8	1.11		1	64,200
7800766	PHC07R033SS32-5L	★ 33	24.4	5	32	200	50	0.8	1.15		2	76,000
7800767	PHC07R035SS32-5L	★ 35	26.4	5	32	200	50	0.8	1.17		2	76,000

★ 刃太タイプ 詳細はp.160をご覧ください。
Reduced Shank Type See p.160 for details.

NEXT

★ PHC 刃太タイプ Reduced Shank Type

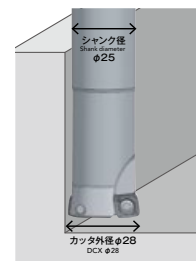
例
Example

・刃太タイプは、シャンク径よりも工具外径の方が大きいため、金型部品などの深い立ち壁加工やポケット加工に最適です

・The outer diameter of the reduced shank type is larger than the shank diameter, making it highly effective in the processing of die and mold applications that require vertical wall milling or pocketing.

FROM

PHC09タイプ PHC09 Type

単位:mm Unit:mm

ツールNo. EDP No.	呼び Designation	カット 外径 DCX	外径 DC	刃数 ZEFF	シャンク径 DCON	全長 LF	首下長 LH	APMX	重量 (kg)	適用インサート Applicable Inserts	形状 タイプ Type	標準価格 (Yen)
7800700	PHC09R025SS25-2S	25	13.2	2	25	140	60	1	0.43	②	1	35,000
7800704	PHC09R025SS25-2L	25	13.2	2	25	200	120	1	0.61		1	43,800
7800724	PHC09R025SS25-2LL	25	13.2	2	25	300	180	1	0.97		1	71,200
7800701	PHC09R025SS25-3S	25	13.2	3	25	140	60	1	0.43		1	43,400
7800705	PHC09R025SS25-3L	25	13.2	3	25	200	120	1	0.61		1	53,800
7800742	PHC09R026SS25-2LL	★ 26	14.2	2	25	300	40	1	1.03		2	71,200
7800740	PHC09R026SS25-3L	★ 26	14.2	3	25	200	40	1	0.65		2	66,800
7800725	PHC09R028SS25-2LL	★ 28	16.2	2	25	300	40	1	1.01		2	71,200
7800716	PHC09R028SS25-3S	★ 28	16.2	3	25	140	40	1	0.45		2	53,500
7800720	PHC09R028SS25-3L	★ 28	16.2	3	25	200	40	1	0.66		2	66,800
7800726	PHC09R030SS32-2LL	30	18.2	2	32	300	180	1	1.54		1	74,900
7800717	PHC09R030SS32-3S	30	18.2	3	32	150	70	1	0.76		1	56,100
7800721	PHC09R030SS32-3L	30	18.2	3	32	200	120	1	1		1	71,200
7800727	PHC09R032SS32-2LL	32	20.2	2	32	300	180	1	1.66		1	74,900
7800702	PHC09R032SS32-3S	32	20.2	3	32	150	70	1	0.79		1	45,700
7800706	PHC09R032SS32-3L	32	20.2	3	32	200	120	1	1.05		1	57,000
7800743	PHC09R033SS32-2LL	★ 33	21.2	2	32	300	50	1	1.71		2	74,900
7800741	PHC09R033SS32-3L	★ 33	21.2	3	32	200	50	1	1.11		2	71,200
7800728	PHC09R035SS32-2LL	★ 35	23.2	2	32	300	50	1	1.73		2	74,900
7800718	PHC09R035SS32-3S	★ 35	23.2	3	32	150	50	1	0.83		2	58,000
7800722	PHC09R035SS32-3L	★ 35	23.2	3	32	200	50	1	1.12		2	71,200
7800729	PHC09R040SS42-2LL	40	28.2	2	42	300	70	1	2.91		1	74,900
7800723	PHC09R040SS42-3L	40	28.2	3	42	250	70	1	2.37		1	83,500
7800703	PHC09R040SS32-4S	40	28.2	4	32	150	50	1	0.86		2	54,600
7800719	PHC09R040SS42-4S	40	28.2	4	42	150	50	1	1.38		1	66,900
7800707	PHC09R040SS32-4L	40	28.2	4	32	250	50	1	1.45		2	67,900

NEXT

Phoenix

高送りラジアスカッタ ストレートシャンクタイプ

High Feed Radius Cutter with Straight Shank

PHC SS

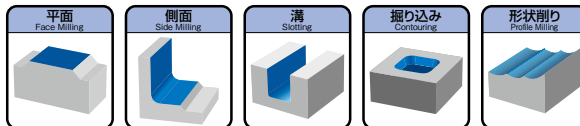

Specification

形状寸法表 Specification

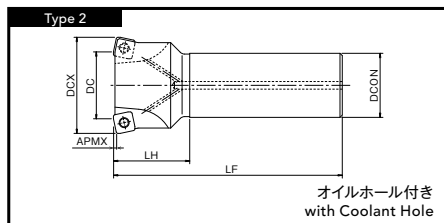
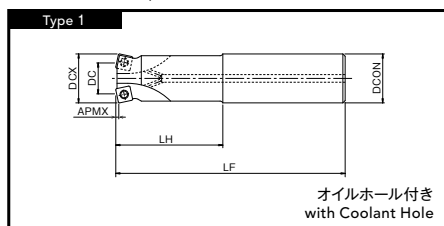

FROM

PHC12タイプ PHC12 Type

単位:mm Unit:mm

ツールNo. EDP No.	呼び Designation	カッタ 外径 DCX	外径 DC	刃数 ZEPF	シャンク径 DCON	全長 LF	首下長 LH	APMX	重量 (kg)	適用インサート Applicable Inserts	形状 タイプ Type	標準価格 (Yen)
7800730	PHC12R030SS32-2S	30	13.4	2	32	150	70	2	0.74	③	1	54,500
7800733	PHC12R030SS32-2L	30	13.4	2	32	200	120	2	0.97		1	85,500
7800736	PHC12R030SS32-2LL	30	13.4	2	32	300	180	2	1.52		1	94,600
7800708	PHC12R032SS32-2S	32	15.4	2	32	150	70	2	0.8		1	41,500
7800712	PHC12R032SS32-2L	32	15.4	2	32	200	120	2	1.06		1	51,800
7800737	PHC12R032SS32-2LL	32	15.4	2	32	300	180	2	1.65		1	94,600
7800744	PHC12R033SS32-2L	★ 33	16.4	2	32	200	50	2	1.11		2	90,400
7800745	PHC12R033SS32-2LL	★ 33	16.4	2	32	300	50	2	1.7		2	94,600
7800738	PHC12R035SS32-2LL	★ 35	18.4	2	32	300	50	2	1.71		2	94,600
7800731	PHC12R035SS32-3S	★ 35	18.4	3	32	150	50	2	0.81		2	58,600
7800734	PHC12R035SS32-3L	★ 35	18.4	3	32	200	50	2	1.11		2	90,400
7800739	PHC12R040SS42-2LL	40	23.4	2	42	300	70	2	2.88		1	96,900
7800709	PHC12R040SS32-3S	40	23.4	3	32	150	50	2	0.85		2	49,800
7800732	PHC12R040SS42-3S	40	23.4	3	42	150	50	2	1.37		1	60,500
7800713	PHC12R040SS32-3L	40	23.4	3	32	250	50	2	1.44		2	74,100
7800735	PHC12R040SS42-3L	40	23.4	3	42	250	70	2	2.36		1	92,500
7800710	PHC12R050SS42-4S	50	33.4	4	42	150	50	2	1.5		2	67,900
7800714	PHC12R050SS42-4L	50	33.4	4	42	250	50	2	2.55		2	95,800
7800711	PHC12R063SS42-5S	63	46.4	5	42	150	50	2	1.67		2	85,500
7800715	PHC12R063SS42-5L	63	46.4	5	42	250	50	2	2.71		2	110,000

★ 刃太タイプ 詳細はp.160をご覧ください。
Reduced Shank Type See p.160 for details.

Phoenix

高送りラジアスカッタ ボアタイプ
High Feed Radius Cutter with Bore Type

PHC BORE

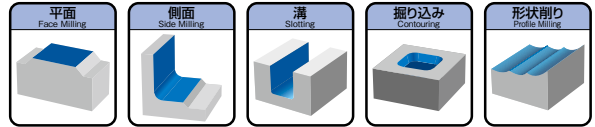

Specification

■形状寸法表 Specification

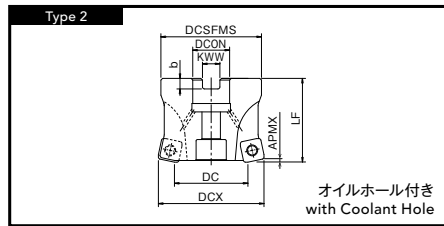
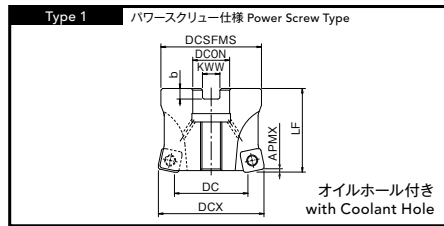

単位:mm Unit:mm

ツールNo. EDP No.	呼び Designation	カッタ 外径 DCX	外径 DC	刃数 ZFP	カッタ 高さ LF	ボス径 DCSFMS	穴径 DCON	端面キー溝 Key Slot		APMX	重量 (kg)	適用インサート Applicable Inserts	形状タイプ Type	標準価格 (Yen)
								幅 KWW	深さ b					
7800600	PHC09R040M16-4	40	28.2	4	40	38	16	8.4	5.6	1	0.23	②	1	63,200
7800601	PHC09R050M22-5	50	38.2	5	50	47	22	10.4	6.3	1	0.43		2	74,900
7800605	PHC09R050M22.2-5	50	38.2	5	50	47	22.225	8.4	5	1	0.44		2	74,900
7800603	PHC09R063M22-6	63	51.2	6	50	60	22	10.4	6.3	1	0.79		2	86,200
7800606	PHC09R063M22.2-6	63	51.2	6	50	60	22.225	8.4	5	1	0.79		2	86,200
7800607	PHC12R040M16-3	40	23.4	3	40	38	16	8.4	5.6	2	0.21		③	1
7800608	PHC12R050M22-4	50	33.4	4	50	47	22	10.4	6.3	2	0.41	2		71,100
7800614	PHC12R050M22.2-4	50	33.4	4	50	47	22.225	8.4	5	2	0.41	2		71,100
7800610	PHC12R063M22-5	63	46.4	5	50	60	22	10.4	6.3	2	0.75	2		81,900
7800615	PHC12R063M22.2-5	63	46.4	5	50	60	22.225	8.4	5	2	0.75	2		81,900
7800618	PHC12R080M31.7-5	80	63.4	5	63	76	31.75	12.7	8	2	1.54	2		92,500
7800612	PHC12R080M27-7	80	63.4	7	50	76	27	12.4	7	2	1.24	2		98,000
7800616	PHC12R080M31.7-7	80	63.4	7	63	76	31.75	12.7	8	2	1.5	2		98,000
7800617	PHC12R100M31.7-8	100	83.4	8	63	96	31.75	12.7	8	2	2.72	2		110,000
7800613	PHC12R100M32-8	100	83.4	8	63	96	32	14.4	8	2	2.72	2		110,000

在庫区分は全てC(標準在庫品)となります。 Stock are categorized as C (Standard stock item).

Phoenix

高送りラジラスカッタ ねじ込みタイプ
High Feed Radius Cutter with Screw Fit Type

PHC SF

Specification

■形状寸法表 Specification

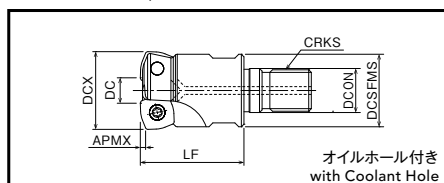

PHC ねじ込みタイプ Screw Fit Type

単位:mm Unit:mm

ツールNo. EDP No.	呼び Designation	カッタ外径 DCX	外径 DC	刃数 ZEPF	取付け径 DCON	ねじサイズ CRKS	スパナサイズ Spanner Size	全長 LF	端面径 DCSFMS	APMX	重量 (kg)	適用インサート Applicable Inserts	適用シャンク ホルダタイプ Applicable Shank	標準価格 (Yen)	
7801520	PHC07R016SF8-2	16	7.4	2	8.5	M 8	10	27	14.5	0.8	0.03	①	③	33,600	
7801521	PHC07R017SF8-2	★17	8.4	2	8.5	M 8	10	27	14.5	0.8	0.03			33,600	
7801522	PHC07R018SF8-2	★18	9.4	2	8.5	M 8	10	27	14.5	0.8	0.03			33,600	
7801523	PHC07R020SF10-3	20	11.4	3	10.5	M10	14	33	18	0.8	0.06		④	46,800	
7801524	PHC07R021SF10-3	★21	12.4	3	10.5	M10	14	33	18	0.8	0.06			46,800	
7801525	PHC07R022SF10-3	★22	13.4	3	10.5	M10	14	33	18	0.8	0.06			46,800	
7801526	PHC07R025SF12-4	25	16.4	4	12.5	M12	17	35	23	0.8	0.1			⑤	59,400
7801527	PHC07R026SF12-4	★26	17.4	4	12.5	M12	17	35	23	0.8	0.1				59,400
7801528	PHC07R028SF12-4	★28	19.4	4	12.5	M12	17	35	23	0.8	0.11				59,400
7801529	PHC07R030SF16-4	30	21.4	4	17	M16	22	40	28	0.8	0.2		⑥	67,500	
7801530	PHC07R032SF16-5	32	23.4	5	17	M16	22	40	28	0.8	0.18			74,300	
7801531	PHC07R033SF16-5	★33	24.4	5	17	M16	22	40	28	0.8	0.18			74,300	
7801532	PHC07R035SF16-5	★35	26.4	5	17	M16	22	40	28	0.8	0.2			74,300	
7801500	PHC09R025SF12-3	25	13.2	3	12.5	M12	17	35	23	1	0.1	②	⑤	75,400	
7801510	PHC09R026SF12-3	★26	14.2	3	12.5	M12	17	35	23	1	0.11			75,400	
7801501	PHC09R028SF12-3	★28	16.2	3	12.5	M12	17	35	23	1	0.11			75,400	
7801502	PHC09R030SF16-3	30	18.2	3	17	M16	22	40	28	1	0.17		⑥	82,700	
7801503	PHC09R032SF16-3	32	20.2	3	17	M16	22	40	28	1	0.18			82,700	
7801511	PHC09R033SF16-3	★33	21.2	3	17	M16	22	40	28	1	0.19			82,700	
7801504	PHC09R035SF16-3	★35	23.2	3	17	M16	22	40	28	1	0.19			82,700	
7801505	PHC09R040SF16-4	40	28.2	4	17	M16	22	40	28	1	0.22			102,000	
7801506	PHC12R030SF16-2	30	13.4	2	17	M16	22	40	28	2	0.17	③	⑥	75,400	
7801507	PHC12R032SF16-2	32	15.4	2	17	M16	22	40	28	2	0.18			75,400	
7801512	PHC12R033SF16-2	★33	16.4	2	17	M16	22	40	28	2	0.19			91,000	
7801508	PHC12R035SF16-3	★35	18.4	3	17	M16	22	40	28	2	0.18		91,000		
7801509	PHC12R040SF16-3	40	23.4	3	17	M16	22	40	28	2	0.22		93,000		

シャンクホルダについてはp.242～p.244をご覧ください。
See p.242-p.244 for shank holders.

★刃太タイプ 詳細はp.160をご覧ください。
Reduced Shank Type See p.160 for details.

Inserts

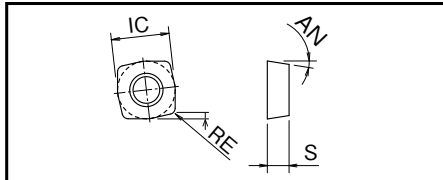

■適用インサート Inserts

単位:mm Unit:mm

呼び Designation	切れ刃数 No. of Cutting Edges	インサート寸法 Insert Size				コーティング材種 Grade of Coated Materials									標準価格 (Yen)
		IC	厚さ S	逃げ角 AN	RE	XC3020	XP3025	XC3030	XP3035	XP2025	XP2040	XC1015	XC5035	XC5040	
① SPMT070305SR-GM	4	7.0	2.75	11°	0.5	7827092	7828092	7825092	7814092	7826092	7813092	7812092			1,280
	4	7.0	2.75	11°	0.5								7816093	2,360	
② SDMT09T308SR-GM	4	9.52	3.97	15°	0.8	7827020	7828020	7825020	7814020	7826020	7813020	7812020			1,430
	4	9.52	3.97	15°	0.8								7815021	7816021	2,590
③ SXMT120410SR-GM	4	12.7	4.76	9°	1	7827022	7828022	7825022	7814022	7826022	7813022	7812022			1,660
	4	12.7	4.76	9°	1								7815023	7816023	3,020

Accessories

■部品 Accessories

	ツールNo. EDP No.	呼び Designation	適用インサート Applicable Inserts	適用ボディ Applicable Body
 クランプねじ Clamping Screw	7808105	FS25550 (Torx 8)	① SPMT07...	PHCSS/SF φ16~35
	7808111	FS35572 (Torx 15)	② SDMT09...	PHC SS/SF φ25~35
	7808112	FS35586 (Torx 15)		PHC SS/SF φ40 PHC BORE φ40~63
	7808113	FS45510 (Torx 20)	③ SXMT12...	PHC SS/SF φ30~63 PHC BORE φ40~100
 パワースクリュー Power Screw	7808150	PS0830 (M8×30)	② SDMT09...	PHC BORE φ40
			③ SXMT12...	

	ツールNo. EDP No.	呼び Designation	適用インサート Applicable Inserts	適用ボディ Applicable Body	標準価格 (Yen)
 レンチ Wrench	7808205	T8-D (Torx 8)	① SPMT07...	PHCSS/SF φ16~35	1,190
	7808208	T15-D (Torx 15)	② SDMT09...	PHC SS/SF φ25~40 PHC BORE φ40~63	1,260
	7808209	T20-D (Torx 20)	③ SXMT12...	PHC SS/SF φ30~63 PHC BORE φ40~100	1,260

レンチは別途ご購入下さい。 The wrenches are sold separately from the cutters.

Phoenix

高送りラジラスカッタシリーズ
High Feed Radius Cutter Series

PHC

被削材別推奨材質

Recommended Materials by Insert Type

◎第一推奨材質 Best
○第二推奨材質 Good

インサート材種 Insert Grades	ブレーカ Insert Breaker	切削油剤 Coolant	P	M	K	N	S	H
XC3020	GM	無 Dry	◎		○			
XP3025	GM	有 Wet	◎		○			
XC3030	GM	無 Dry	◎		○			
XP3035	GM	無 Dry	◎	○	○			
		有 Wet						
XP2025	GM	有 Wet	○	◎			○	
XP2040	GM	無 Dry	○	◎				○
		有 Wet	○	◎			○	
XC1015	GM	無 Dry			◎			
XC5035	SM	無 Dry		◎				
		有 Wet		○			○	
XC5040	SM	有 Wet		○			◎	

GM:中切削用 SM:耐熱合金用
GM:Middle Cutting SM:Heat Resistance Alloy

Cutting Conditions

切削条件基準表 Cutting Conditions

被削材 Work Material	引張強さ・硬さ Tensile Strength Hardness	切削速度 Vc (m/min) Cutting Speed	インサートサイズ Insert Size											
			SPMT07...			SDMT09...			SXMT12...					
			一刃当たりの送り量 fz (mm/t) Feed per Tooth	切込深さ ap (mm) Depth of Cut			一刃当たりの送り量 fz (mm/t) Feed per Tooth	切込深さ ap (mm) Depth of Cut			一刃当たりの送り量 fz (mm/t) Feed per Tooth	切込深さ ap (mm) Depth of Cut		
				L/D=2	L/D=3	L/D=4		L/D=2	L/D=3	L/D=4		L/D=2	L/D=3	L/D=4
P 軟鋼、低炭素鋼 Mild Steel, Low Carbon Steel (S5400, S10C) 炭素鋼、合金鋼 Carbon Steel, Alloy Steel (S50C, SCM440) ダイス鋼 Die Steel (SKD11, SKD61)	~180HB	180 (60 ~ 250)	0.7 (0.3 ~ 1.5)	0.8	0.6	0.4	0.8 (0.3 ~ 1.8)	1	0.8	0.5	1.25 (0.5 ~ 3.2)	1.2	1.2	1
	~280HB	180 (60 ~ 250)	0.7 (0.3 ~ 1.3)	0.8	0.6	0.4	0.8 (0.3 ~ 1.5)	1	0.8	0.5	1.25 (0.5 ~ 3)	1.2	1.2	1
	~280HB	180 (60 ~ 250)	0.7 (0.3 ~ 1.3)	0.6	0.5	0.3	0.8 (0.3 ~ 1.5)	0.8	0.6	0.4	1.25 (0.5 ~ 3)	1.2	1.2	1
M ステンレス鋼(乾式) Stainless Steel (Dry) (SUS304, SUS420) ステンレス鋼(湿式) Stainless Steel (Wet) (SUS304, SUS420)	~250HB	160 (80 ~ 200)	0.4 (0.3 ~ 1.2)	0.6	0.5	0.3	0.5 (0.3 ~ 1.5)	0.8	0.6	0.4	1 (0.5 ~ 2.5)	1.2	1	1
	~250HB	120 (60 ~ 180)	0.4 (0.3 ~ 1.2)	0.6	0.5	0.3	0.5 (0.3 ~ 1.5)	0.8	0.6	0.4	1 (0.5 ~ 2.5)	1.2	1	1
K 鑄鉄 Cast Iron (FC250) ダクタイル鑄鉄 Ductile Cast Iron (FCD400)	~350N/mm ²	200 (100 ~ 300)	0.8 (0.4 ~ 1.5)	0.8	0.6	0.4	1 (0.5 ~ 1.8)	1	0.8	0.5	1.5 (0.5 ~ 3.5)	1.5	1.5	1
	~800N/mm ²	180 (100 ~ 250)	0.7 (0.3 ~ 1.3)	0.8	0.6	0.4	0.9 (0.5 ~ 1.5)	1	0.8	0.5	1.35 (0.5 ~ 3)	1.2	1.2	0.9
S 超耐熱合金(湿式) Superalloy (Wet) (Inconel 718) チタン合金(湿式) Titanium Alloy (Wet) (Ti-6Al-4V)	-	30 (25 ~ 60)	0.3 (0.2 ~ 0.7)	0.4	0.4	0.3	0.4 (0.2 ~ 0.8)	0.5	0.5	0.4	0.5 (0.2 ~ 1)	1	1	0.8
	-	80 (50 ~ 120)	0.4 (0.3 ~ 0.8)	0.4	0.4	0.3	0.5 (0.3 ~ 1)	0.5	0.5	0.3	0.7 (0.3 ~ 1.2)	0.8	0.8	0.4
H プリハードン鋼 Pre-hardened Steel (NAK80) ダイカスト用鋼 Steel for Die Casting (DAC-MAGIC, DH31) 調質鋼 Hardened Steel (SKD11)	40~43HRC	120 (40 ~ 150)	0.4 (0.2 ~ 0.8)	0.4	0.4	0.3	0.5 (0.2 ~ 1)	0.5	0.5	0.3	0.8 (0.3 ~ 1.5)	1	1	0.5
	43~48HRC	90 (40 ~ 120)	0.3 (0.2 ~ 0.6)	0.4	0.4	0.3	0.4 (0.2 ~ 0.8)	0.5	0.5	0.3	0.7 (0.3 ~ 1.2)	0.7	0.7	0.5
	50~55HRC	60 (40 ~ 90)	0.2 (0.2 ~ 0.5)	0.3	0.3	0.2	0.3 (0.2 ~ 0.7)	0.3	0.3	0.2	0.5 (0.3 ~ 0.8)	0.5	0.5	0.4

上記の数値は実切削速度における一般的な値を示したものです。加工環境に合わせて適宜調整して下さい。
The above cutting conditions are to be used as general guidelines. Adjustments may be necessary depending on actual cutting condition.

Maximum Ramping Angle (E)

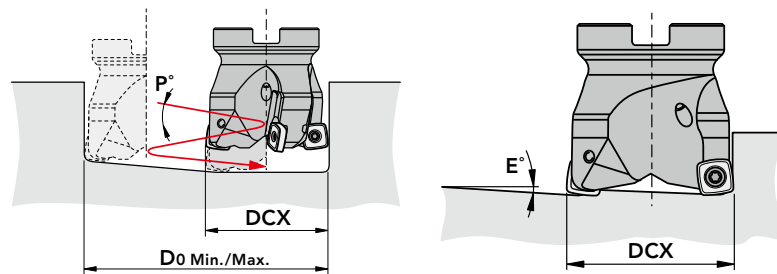

■ランピング加工時の最大傾斜角(E) Maximum Ramping Angle (E)

インサートサイズ Insert Size	SPMT07...				SDMT09...				SXMT12...			
	ランピング角度 Ramping Angle E°	ヘリカル穴あけ Helical Milling (mm)		ヘリカル角度 Helical Angle P°	ランピング角度 Ramping Angle E°	ヘリカル穴あけ Helical Milling (mm)		ヘリカル角度 Helical Angle P°	ランピング角度 Ramping Angle E°	ヘリカル穴あけ Helical Milling (mm)		ヘリカル角度 Helical Angle P°
		最小径 Do Min.	最大径 Do Max.			最小径 Do Min.	最大径 Do Max.			最小径 Do Min.	最大径 Do Max.	
16	5.9	22	31	4.5	-	-	-	-	-	-	-	-
17	4.9	24	33	3.6	-	-	-	-	-	-	-	-
18	4.2	26	35	3.1	-	-	-	-	-	-	-	-
20	3.2	30	39	2.3	-	-	-	-	-	-	-	-
21	2.8	32	41	2.0	-	-	-	-	-	-	-	-
22	2.6	34	43	1.8	-	-	-	-	-	-	-	-
25	2.0	40	49	1.3	3.6	35	48	3.1	-	-	-	-
26	1.8	42	51	1.1	3.1	37	50	2.6	-	-	-	-
28	1.6	46	55	1.0	2.6	41	54	2.1	-	-	-	-
30	1.4	50	59	0.8	2.2	45	58	1.9	7.9	40	58	6.5
32	1.3	54	63	0.7	2.0	49	62	1.7	7.2	44	62	6.1
33	1.2	56	65	0.6	1.8	51	64	1.5	6.4	46	64	4.4
35	1.1	60	69	0.5	1.6	55	68	1.4	4.4	50	68	3.7
40	-	-	-	-	1.2	65	78	1.0	2.9	60	78	2.5
50	-	-	-	-	0.9	85	98	0.8	1.5	80	98	1.3
63	-	-	-	-	0.8	111	124	0.7	1.1	106	124	0.9
80	-	-	-	-	-	-	-	-	1.3	140	158	1.1
100	-	-	-	-	-	-	-	-	0.7	180	198	0.6

■プログラム作成上の刃先形状定義

Flute shape definitions for the purpose of creating a program

単位:mm Unit:mm

インサートサイズ Insert Size	RE	最大切込み ap Max.	擬似R rt	取り代残 Z
SPMT07...	0.5	0.8	1.2	0.35
SDMT09...	0.8	1	2	0.7
SXMT12...	1	2	3	1.15

加工に際しては、それぞれ擬似Rのラジラスカッタとして加工プログラムを作成下さい。
During machining, please program the milling paths according to the recommended simulated R (rt) respective to the individual cutter diameter.

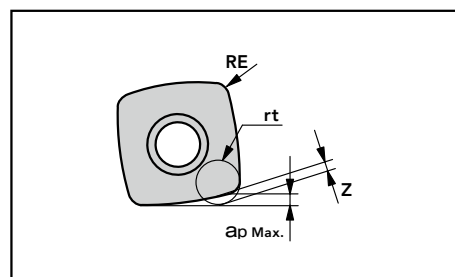

Cutting Data

■加工データ Cutting Data

■モールドベース荒取り加工 Rough milling of mold base

使用工具 Tool	PHC07R020SS20-3S (φ20×3刃)	他社品 Competitor
使用インサート(材種) Insert (grade)	SPMT070305SR-GM (XC3020)	超硬コーティングインサート Coated Carbide Insert
被削材 Work Material	S50C	
切削速度 Cutting Speed	157m/min (2,500min ⁻¹)	
送り速度 Feed	6,000mm/min (0.8mm/t)	
切込深さ Depth of Cut	ap=0.5mm ae=14mm	
切削油剤 Coolant	なし(エアブロー) Air Blow	
使用機械 Machine	立形マシニングセンタ(BT50) Vertical Machining Center	

耐摩耗性の高いXC3020は摩耗進行の抑制が可能となり、約1.5倍の耐久UPが可能となった。

XC3020 with high wear resistance properties was able to suppress wear and achieve 1.5 times the durability.

	切削長さ (m) Milling Length									
	100	200	300	400	500	600	700	800	900	
PHC										
他社品 Competitor										

PHC 900m 加工時の写真
After 900 of milling



■ダイカスト金型荒取り加工 Rough milling of die-casting dies

使用工具 Tool	PHC09R063M22-6 (φ63×6刃)	他社品 Competitor
使用インサート(材種) Insert (grade)	SDMT09T308SR-GM (XP2040)	超硬コーティングインサート Coated Carbide Insert
被削材 Work Material	DAC55 (48HRC)	
切削速度 Cutting Speed	75m/min (379min ⁻¹)	118m/min (596min ⁻¹)
送り速度 Feed	1,250mm/min (0.55mm/t)	600mm/min (0.25mm/t)
切込深さ Depth of Cut	ap=0.7mm ae=25.5mm	
切削油剤 Coolant	なし(エアブロー) Air Blow	
突出し長さ Overhang Length	145mm	
使用機械 Machine	立形マシニングセンタ(BT50) Vertical Machining Center	

ダイカスト金型の荒取り加工。他社品に比べて2倍の能率で加工が可能であり、さらに2倍の耐久を得られた。また低抵抗仕様により発熱量を抑えられることから切りくずの色も茶褐色で安定していた。

This product was able to mill at double the efficiency of a competitor's product while doubling the durability. Due to its low-resistance construction, it minimizes heat generation, resulting in a stable discharge of brownish chips.

	切削長さ (m) Milling Length						
	50	100	150	200	250	300	350
PHC							
他社品 Competitor							

ダイカスト金型荒取り加工 Rough milling of die-casting dies

使用工具 Tool	PHC09R050M22-5 (φ50×5刃)	他社品 Competitor
使用インサート(材種) Insert (grade)	SDMT09T308SR-GM (XP2040)	超硬コーティングインサート Coated Carbide Insert
被削材 Work Material	SKD61 (48HRC)	
切削速度 Cutting Speed	80m/min (510min ⁻¹)	110m/min (700min ⁻¹)
送り速度 Feed	1,360mm/min (0.53mm/t)	800mm/min (0.28mm/t)
切込深さ Depth of Cut	ap=0.5mm ae=25mm	
切削油剤 Coolant	なし(エアブロー) Air Blow	
使用機械 Machine	横形マシニングセンタ(BT50) Horizontal Machining Center	

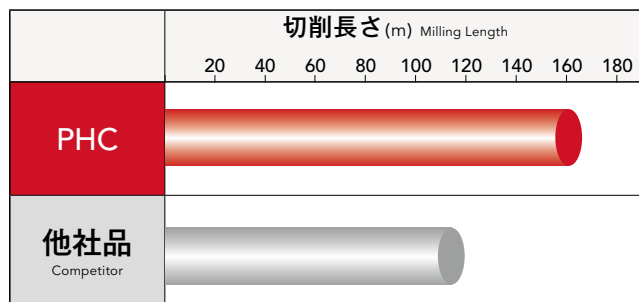

低抵抗刃形により他社品に対し能率1.7倍での加工が可能であり、さらに1.4倍の耐久が得られた。また他社品では加工による発熱からワークに歪みがでていたがPHCでは発熱量を抑えられることからワークの歪みを改善することができた。

Due to its low-resistance edge form, this product was able to mill at 1.7 times the efficiency of the competitor's tool, and achieved 1.4 times the durability. Additionally, the heat generated by the competitor's tool created a distortion in the workpiece, while the PHC was able to improve the process by suppressing the generation of heat.

プラスチック金型荒取り加工 Rough milling of plastic dies

使用工具 Tool	PHC12R050M22-4 (φ50×4刃)	他社品 Competitor
使用インサート(材種) Insert (grade)	SXMT120410SR-GM (XP2040)	超硬コーティングインサート Coated Carbide Insert
被削材 Work Material	PX5 (30HRC)	
切削速度 Cutting Speed	157m/min (1,000min ⁻¹)	
送り速度 Feed	3,000mm/min (0.75mm/t)	
切込深さ Depth of Cut	ap=0.75mm ae=25mm	
切削油剤 Coolant	水溶性切削油剤 Water-Soluble	
使用機械 Machine	立形マシニングセンタ(HSK-A100) Vertical Machining Center	

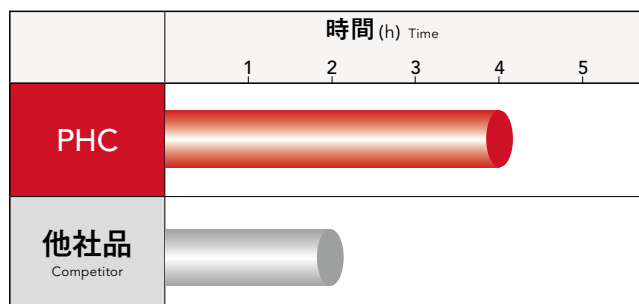

金型の形状荒取り加工において他社品に比べ約2倍の耐久を得られた。

While rough milling a die using the same conditions as the competitor's tools, this product has doubled the durability.

Cutting Data

加工データ Cutting Data

プラスチック金型の荒取り加工 Rough milling of plastic dies

使用工具 Tool	PHC12R063M22-5 (φ63×5刃)	他社品 Competitor
使用インサート(材種) Insert (grade)	SXMT120410SR-GM (XP2040)	超硬コーティングインサート Coated Carbide Insert
被削材 Work Material	HPM7 (33HRC)	
切削速度 Cutting Speed	100m/min (505min ⁻¹)	
送り速度 Feed	2,500mm/min (1mm/t)	
切込深さ Depth of Cut	ap=1.5mm ae=40mm	
切削油剤 Coolant	なし(エアブロー) Air Blow	
使用機械 Machine	立形マシニングセンタ(BT50) Vertical Machining Center	

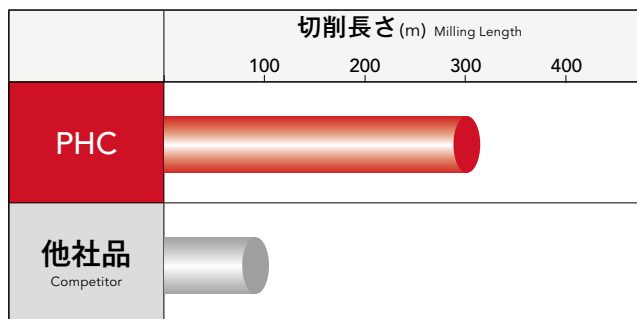

他社品は早期に欠損が発生していたが、PHCは安定して加工することができ同条件で約3倍の長さの加工が可能であった。

A competitor's product chipped prematurely, but the PHC exhibited minimum resistance, inhibiting chipping and allowing it to mill three times the distance under the same conditions.

プレス金型の荒取り加工 Rough milling of press dies

使用工具 Tool	PHC12R050M22-4 (φ50×4刃)	他社品 Competitor
使用インサート(材種) Insert (grade)	SXMT120410SR-GM (XP2040)	超硬コーティングインサート Coated Carbide Insert
被削材 Work Material	SKD11相当品 Equivalent	
切削速度 Cutting Speed	112m/min (713min ⁻¹)	
送り速度 Feed	2,400mm/min (0.84mm/t)	2,000mm/min (0.7mm/t)
切込深さ Depth of Cut	ap=1.25mm ae=32.2mm	
切削油剤 Coolant	なし(エアブロー) Air Blow	
使用機械 Machine	門形マシニングセンタ(BT50) Double Column Machining Center	

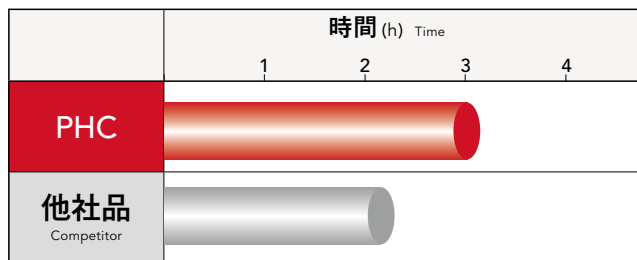

プレス金型における鋼材の荒取り加工。他社品では欠けが発生してしまうため、送りを上げられなかったがPHCでは条件20%UPにて安定した加工ができ、1.5倍の耐久が可能であった。

This process consisted of rough-milling of steel for a press die. A competitor's product could not increase the feed rate due to chipping. The PHC was able to mill with stability while increasing the conditions by 20%, and also provided 1.5 times the durability.

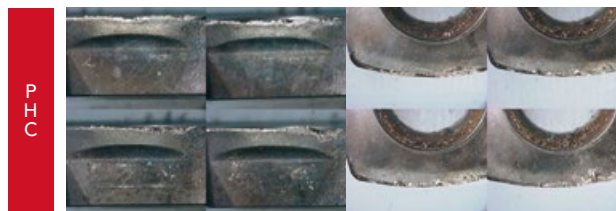

Inconel 718の長寿命加工 Long tool life in Inconel 718

使用工具 Tool	PHC07R025SS25-4S (φ25×4刃)	他社品 Competitor
使用インサート(材種) Insert (grade)	SPMT070305ER-SM (XC5040)	超硬コーティングインサート Coated Carbide Insert
被削材 Work Material	Inconel 718 (41HRC)	
切削速度 Cutting Speed	30m/min (382min ⁻¹)	
送り速度 Feed	764mm/min (0.5mm/t)	
切込深さ Depth of Cut	ap=0.5mm ae=25mm	
切削油剤 Coolant	水溶性切削油剤 Water-Soluble	
使用機械 Machine	横形マシニングセンタ(BT50) Horizontal Machining Center	

PHC (XC5040)は摩耗の抑制により耐久UPが可能となった。また溝加工において切りくずの噛み込み等も無く、良好な切りくず排出性により優れた加工面となった。

PHC (XC5040) was able to suppress wear to prolong durability. Furthermore, its unique flute geometry enables smooth chip evacuation, which contributed to an excellent surface finish.

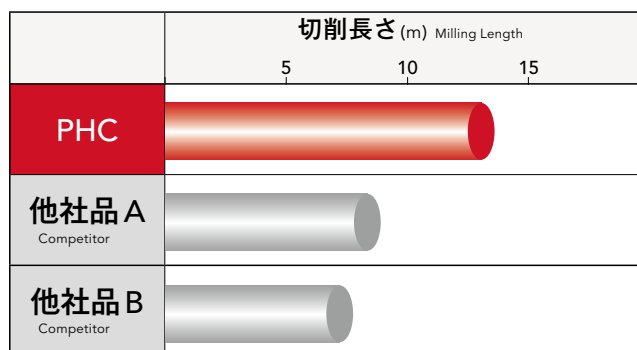
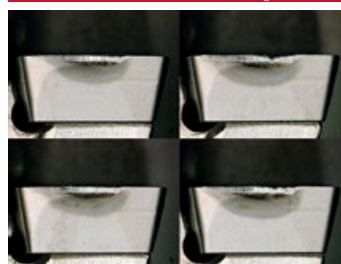
PHC (13.2m加工時点)
After 13.2m of milling

ブレード荒取り加工 Rough milling of blades

使用工具 Tool	PHC09R032SS32-3S (φ32×3刃)	他社品 Competitor
使用インサート(材種) Insert (grade)	SDMT09T308ER-SM (XC5040)	超硬コーティングインサート Coated Carbide Insert
被削材 Work Material	SUS630	
切削速度 Cutting Speed	80m/min (796min ⁻¹)	
送り速度 Feed	800mm/min (0.33mm/t)	
切込深さ Depth of Cut	ap=0.5mm ae= ~32mm	
切削油剤 Coolant	水溶性切削油剤 Water-Soluble	
使用機械 Machine	立形マシニングセンタ(BT40) Vertical Machining Center	

ブレードの荒取り加工において同条件にて比較を行ったが1.75倍の耐久が得られた。インサートは正常摩耗で安定した加工が可能であり、さらに継続加工が可能な状態であった。

A blade was rough-milled under the same conditions for comparison. This tool provided 1.75 times the durability, and milled in a stable manner with inserts exhibiting normal wear. Moreover, it was capable of continued milling.

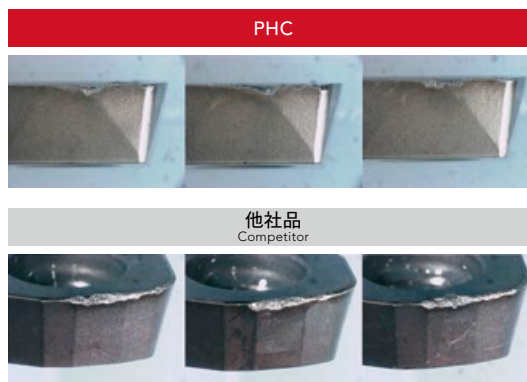
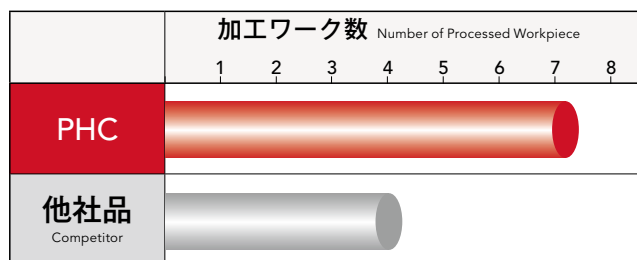

» Phoenix PRC

丸駒カッタシリーズ
Radius Cutter Series

Phoenix Radius Cutter



■ 特長 Features

押え金が不要なため、
切りくず排出がスムーズ

Because it does not need a pressure bar,
it can evacuate chips smoothly.

広いインサートポケットにより切りくず排出性を向上

Chip ejection is improved by wide chip pockets.

インサート回転止め
Insert rotation stopper



インサートの切欠けに合わせてセッティング
Cutout is set to the insert rotation stopper of body.

3次元加工に対応した
ボディ逃がし形状

Body relief shape support
3 dimensional machining.

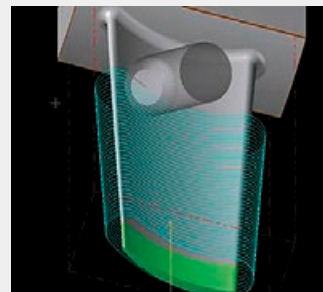

【裏側 Back side】

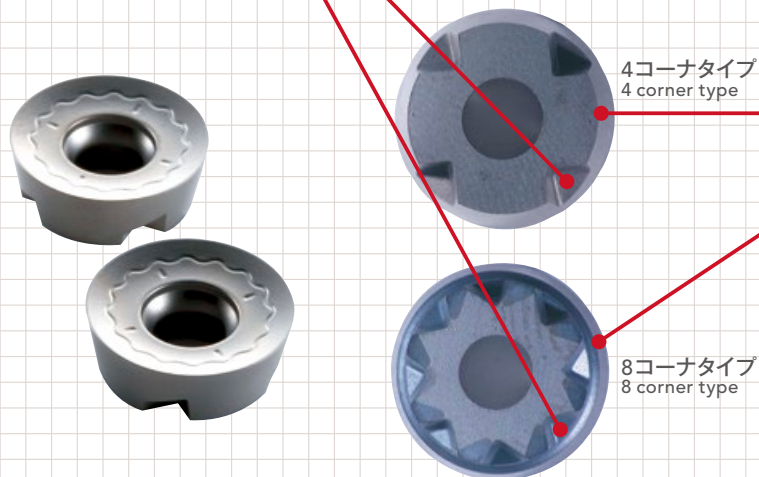

4コーナタイプ
4 corner type

8コーナタイプ
8 corner type

切込み量設定により
使用コーナ数が選択可能
(4&8コーナ)

Either 4 or 8 corner can be selected by
depending on the depth of cut.

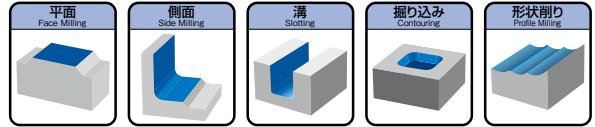

Specification

■形状寸法表 Specification

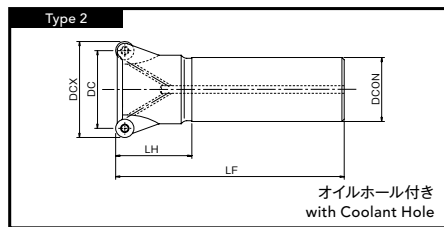
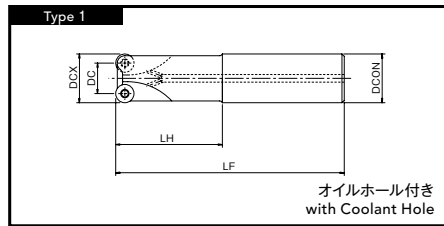

単位:mm Unit:mm

ツールNo. EDP No.	呼び Designation	カッタ 外径 DCX	外径 DC	刃数 ZEPF	シャンク径 DCON	全長 LF	首下長 LH	重量 (kg)	適用インサート Applicable Inserts	形状 タイプ Type	標準価格 (Yen)
7800300	PRC10R020SS20-2S	20	10	2	20	130	50	0.27	①	1	37,000
7800303	PRC10R020SS20-2L	20	10	2	20	180	80	0.38		1	38,800
7800301	PRC10R025SS25-3S	25	15	3	25	140	60	0.44		1	47,000
7800304	PRC10R025SS25-3L	25	15	3	25	200	120	0.62		1	49,500
7800302	PRC10R032SS32-4S	32	22	4	32	150	70	0.8		1	54,500
7800305	PRC10R032SS32-4L	32	22	4	32	200	120	1.05		1	57,700
7800322	PRC12R024SS25-2S	24	12	2	25	140	60	0.44	②	1	51,600
7800323	PRC12R024SS25-2L	24	12	2	25	180	100	0.56		1	56,700
7800318	PRC12R030SS32-2S	30	18	2	32	150	70	0.75		1	80,300
7800319	PRC12R030SS32-2L	30	18	2	32	200	120	0.96		1	86,600
7800306	PRC12R032SS32-2S	32	20	2	32	150	70	0.79		1	54,300
7800309	PRC12R032SS32-2L	32	20	2	32	200	120	1.04		1	58,800
7800320	PRC12R032SS32-3S	32	20	3	32	150	70	0.78		1	83,500
7800321	PRC12R032SS32-3L	32	20	3	32	200	120	1.02		1	89,100
7800307	PRC12R040SS32-3S	40	28	3	32	150	50	0.88		2	67,500
7800310	PRC12R040SS32-3L	40	28	3	32	250	50	1.49		2	72,200
7800308	PRC12R050SS42-4S	50	38	4	42	150	50	1.52		2	78,100
7800311	PRC12R050SS42-4L	50	38	4	42	250	50	2.58		2	82,900
7800324	PRC16R032SS32-2S	32	16	2	32	150	70	0.78	③	1	53,200
7800325	PRC16R032SS32-2L	32	16	2	32	200	120	1.05		1	58,000
7800312	PRC16R040SS32-2S	40	24	2	32	150	50	0.85		2	59,600
7800315	PRC16R040SS32-2L	40	24	2	32	250	50	1.46		2	70,900
7800313	PRC16R050SS42-3S	50	34	3	42	150	50	0.49		2	66,100
7800316	PRC16R050SS42-3L	50	34	3	42	250	50	2.55		2	85,500
7800314	PRC16R063SS42-4S	63	47	4	42	150	50	1.63		2	74,600
7800317	PRC16R063SS42-4L	63	47	4	42	250	50	2.69	2	92,600	

Phoenix

丸駒カッタ ボアタイプ

Radius Cutter with Bore Type

PRC BORE

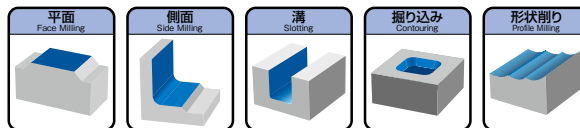

Specification

■形状寸法表 Specification

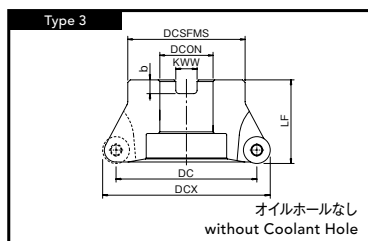
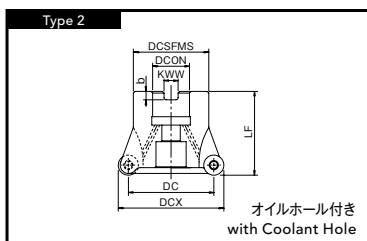
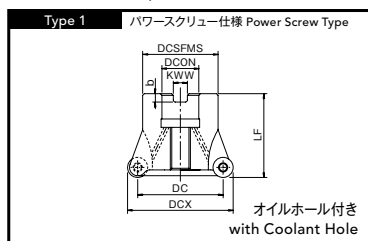

単位:mm Unit:mm

ツールNo. EDP No.	呼び Designation	カッタ 外径 DCX	外径 DC	刃数 ZEPF	カッタ 高さ LF	ボス径 DCSFMS	穴径 DCON	端面キー溝 Key Slot		重量 (kg)	適用インサート Applicable Inserts	形状 タイプ Type	標準価格 (Yen)
								幅 KWW	深さ b				
7800200	PRC12R050M22-4	50	38	4	40	45	22	10.4	6.3	0.27	②	2	57,700
7800204	PRC12R050M22-5	50	38	5	40	45	22	10.4	6.3	0.29		2	67,400
7800201	PRC12R063M22-4	63	51	4	40	50	22	10.4	6.3	0.43		2	63,400
7800206	PRC12R063M22-6	63	51	6	40	50	22	10.4	6.3	0.44		2	83,900
7800209	PRC12R080M25.4-5	80	68	5	50	60	25.4	9.5	6	0.85		2	76,400
7800202	PRC12R080M27-5	80	68	5	50	60	27	12.4	7	0.83		2	76,400
7800211	PRC12R080M25.4-8	80	68	8	50	60	25.4	9.5	6	0.93		2	103,000
7800207	PRC12R080M27-8	80	68	8	50	60	27	12.4	7	0.92		2	103,000
7800210	PRC12R100M31.7-6	100	88	6	50	70	31.75	12.7	8	1.22		3	84,600
7800203	PRC12R100M32-6	100	88	6	50	70	32	14.4	8	1.36		2	84,600
7800212	PRC12R100M31.7-10	100	88	10	50	70	31.75	12.7	8	1.29	3	126,000	
7800208	PRC12R100M32-10	100	88	10	50	70	32	14.4	8	1.43	2	126,000	
7800213	PRC16R050M22-3	50	34	3	40	45	22	10.4	6.3	0.28	③	1	59,100
7800214	PRC16R063M22-5	63	47	5	40	50	22	10.4	6.3	0.37		2	85,500
7800218	PRC16R080M25.4-6	80	64	6	50	60	25.4	9.5	6	0.84		2	104,000
7800216	PRC16R080M27-6	80	64	6	50	60	27	12.4	7	0.83		2	104,000
7800219	PRC16R100M31.7-7	100	84	7	50	70	31.75	12.7	8	1.2		3	122,000
7800217	PRC16R100M32-7	100	84	7	50	70	32	14.4	8	1.32	2	122,000	

Specification

■形状寸法表 Specification

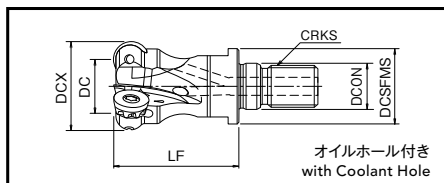

PRC ねじ込みタイプ Screw Fit Type

単位:mm Unit:mm

ツールNo. EDP No.	呼び Designation	カッタ外径 DCX	外径 DC	刃数 ZEPP	取付け径 DCON	ねじサイズ CRKS	スパナサイズ Spanner Size	全長 LF	端面径 DCSFMS	重量 (kg)	適用インサート Applicable Inserts	適用シャンク ホルダタイプ Applicable Shank	標準価格 (¥)
7801700	PRC10R020SF10-2	20	10	2	10.5	M10	14	33	18	0.06	①	④	57,300
7801701	PRC10R025SF12-3	25	15	3	12.5	M12	17	35	23	0.09		⑤	71,100
7801702	PRC10R030SF16-3	30	20	3	17	M16	22	40	28	0.16		⑥	78,900
7801703	PRC10R032SF16-4	32	22	4	17	M16	22	40	28	0.17			87,800
7801704	PRC10R040SF16-4	40	30	4	17	M16	22	40	28	0.21			96,900
7801705	PRC12R030SF16-2	30	18	2	17	M16	22	40	28	0.16	②	⑥	84,000
7801706	PRC12R032SF16-3	32	20	3	17	M16	22	40	28	0.16		87,100	
7801707	PRC12R040SF16-3	40	28	3	17	M16	22	40	28	0.22		87,100	

シャンクホルダについてはp.242 ~ p.244をご覧ください。
See p.242-p.244 for shank holders.

Phoenix

丸駒カッタシリーズ
Radius Cutter Series

PRCインサート

Inserts

Inserts

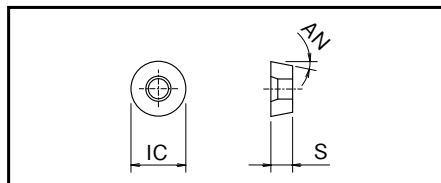

■適用インサート Inserts

単位:mm Unit:mm

呼び Designation	コーナ (切れ刃)数 No. of Cutting Edges	インサート寸法 Insert Size			コーティング材種 Grade of Coated Materials									標準価格 (円)		
		内接円径 IC	厚さ S	逃げ角 AN	超硬 Uncoated				コーティング材種 Grade of Coated Materials							
					CK010	XC3030	XP3035	XP2025	XP2040	XC1015	XC5035	XC5040	XP6015			
①	RPHT10T3MOFN-NM	8	10	3.97	11°	7811009										1,630
	RPHW10T3MOSN	8	10	3.97	11°		7825017									1,660
	RPHW10T3MOEN	8	10	3.97	11°			7814030								1,430
	RPHW10T3MOEN	8	10	3.97	11°						7812017					1,660
	RPHT10T3MOEN-GL	8	10	3.97	11°		7825008	7814008	7826008	7813008						1,660
	RPHT10T3MOEN-GM	8	10	3.97	11°		7825009	7814009								1,660
	RPHT10T3MOEN-SM	4	10	3.97	11°							7815010*				2,790
	RPHT10T3M8EN-SM	8	10	3.97	11°							7815050	7816050			2,790
RPMT10T3M8EN-HR	8	10	3.97	11°									7824083		1,660	
②	RPHT1204MOFN-NM	8	12	4.76	11°	7811013										1,660
	RPHW1204MOSN	8	12	4.76	11°		7825018				7812018					1,700
	RPHW1204MOSN	8	12	4.76	11°			7814018								1,490
	RPHT1204MOEN-GL	8	12	4.76	11°				7826011	7813011						1,700
	RPHT1204MOEN-GM	8	12	4.76	11°		7825011	7814011								1,700
	RPHT1204M8EN-SM	8	12	4.76	11°							7815051	7816051			2,990
RPMT1204M8EN-HR	8	12	4.76	11°									7824084		1,700	
③	RPHT1605MOFN-NM	8	16	5.56	11°	7811016										2,030
	RPHW1605MOSN	8	16	5.56	11°		7825019				7812019					2,110
	RPHW1605MOSN	8	16	5.56	11°			7814019								1,820
	RPHT1605MOEN-GL	8	16	5.56	11°				7826014	7813014						2,110
	RPHT1605MOEN-SM	4	16	5.56	11°							7815015*				4,330
RPHT1605M8EN-SM	8	16	5.56	11°							7815052	7816052			4,310	

*印は在庫なくなり次第、廃番となります。 * Marked insert will be discontinued when it is out of stock.

Accessories

■部品 Accessories

	ツールNo. EDP No.	呼び Designation	適用インサート Applicable Inserts	適用ボディ Applicable Body
 クランプねじ Clamping Screw	7808116	FS30573A (Torx 10)	① RPH*10...	PRC SS/SF φ20~40
	7808112	FS35586 (Torx 15)	② RPH*12...	PRC SS/SF φ32~50 PRC BORE φ50~100
	7808113	FS45510 (Torx 20)	③ RPH*16...	PRC SS/SF φ32~63 PRC BORE φ50~100
 パワースクリュー Power Screw	7808151	PS1031 (M10x31)	③ RPH*16...	PRC BORE φ50

	ツールNo. EDP No.	呼び Designation	適用インサート Applicable Inserts	適用ボディ Applicable Body	標準価格 (円)
 レンチ Wrench	7808207	T10-D (Torx 10)	① RPH*10...	PRC SS/SF φ20~40	1,190
	7808208	T15-D (Torx 15)	② RPH*12...	PRC SS/SF φ32~50 PRC BORE φ50~100	1,260
	7808209	T20-D (Torx 20)	③ RPH*16...	PRC SS/SF φ32~63 PRC BORE φ50~100	1,260

レンチは別途ご購入下さい。 The wrenches are sold separately from the cutters.

被削材別推奨材質

Recommended Materials by Insert Type

◎第一推奨材質 Best
○第二推奨材質 Good

インサート材種 Insert Grades	ブレーカ Insert Breaker	切削油剤 Coolant	P	M	K	N	S	H
CK010	NM	有 Wet				◎		
XC3030	- GL GM	無 Dry	◎		○			
		有 Wet	◎	○	○			
XP3035	- GL GM	無 Dry	◎	○	○			
XP2025	GL	有 Wet	○	◎			○	
		無 Dry	○	○				○
XP2040	GL	有 Wet	○	◎			○	
		無 Dry	○	◎				○
XC1015	-	無 Dry			◎			
XC5035	SM	無 Dry		◎				
		有 Wet		○			○	
XC5040	SM	有 Wet		○			◎	
		無 Dry		○				◎
XP6015	HR	無 Dry	○		○			◎

NM:アルミニウム合金用 GL:軽・中切削用 GM:中切削用 HR:高硬度鋼用 SM:耐熱合金用
 NM:Aluminum Alloy GL:Light・Middle Cutting GM:Middle Cutting HR:High Hardened Steel SM:Heat Resistance Alloy

Cutting Conditions

切削条件基準表 Cutting Conditions

被削材 Work Material	引張強さ・硬さ Tensile Strength・Hardness	切削速度 Vc (m/min) Cutting Speed	インサートサイズ Insert Size								
			RPH*10...		RPH*12...		RPH*16...				
			一刃当たりの 送り量 fz (mm/t) Feed per Tooth	切込深さ ap (mm) Depth of Cut	一刃当たりの 送り量 fz (mm/t) Feed per Tooth	切込深さ ap (mm) Depth of Cut	一刃当たりの 送り量 fz (mm/t) Feed per Tooth	切込深さ ap (mm) Depth of Cut			
P 軟鋼、低炭素鋼 Mild Steel, Carbon Steel (S5400, S10C)	~180HB	200 (100 ~ 300)	0.25 (0.1 ~ 0.35)	2	0.3 (0.1 ~ 0.4)	2.4	0.35 (0.1 ~ 0.5)	3.2			
			炭素鋼、合金鋼 Carbon Steel, Alloy Steel (S50C, SCM440)	~280HB	180 (100 ~ 250)	0.2 (0.1 ~ 0.3)	2	0.25 (0.1 ~ 0.35)	2.4	0.3 (0.1 ~ 0.45)	3.2
			ダイス鋼 Die Steel (SKD11, SKD61)	~280HB	150 (80 ~ 200)	0.2 (0.1 ~ 0.3)	2	0.25 (0.1 ~ 0.35)	2.4	0.3 (0.1 ~ 0.45)	3.2
M ステンレス鋼(乾式) Stainless Steel (Dry) (SUS304, SUS420)	~250HB	160 (80 ~ 200)	0.25 (0.1 ~ 0.35)	2	0.3 (0.1 ~ 0.4)	2.4	0.35 (0.1 ~ 0.5)	3.2			
			ステンレス鋼(湿式) Stainless Steel (Wet) (SUS304, SUS420)	~250HB	120 (60 ~ 180)	0.25 (0.1 ~ 0.35)	2	0.3 (0.1 ~ 0.4)	2.4	0.35 (0.1 ~ 0.5)	3.2
K 鋳鉄 Cast Iron (FC250)	~350N/mm ²	220 (100 ~ 350)	0.25 (0.05 ~ 0.4)	2	0.3 (0.1 ~ 0.5)	2.4	0.35 (0.1 ~ 0.6)	3.2			
			ダクタイル鋳鉄 Ductile Cast Iron (FCD400)	~800N/mm ²	150 (100 ~ 220)	0.2 (0.1 ~ 0.3)	2	0.25 (0.1 ~ 0.35)	2.4	0.3 (0.1 ~ 0.45)	3.2
N アルミニウム合金 Aluminum Alloy	~13%Si	600 (300 ~ 1,500)	0.4 (0.2 ~ 0.8)	2	0.6 (0.2 ~ 1)	2.4	0.8 (0.3 ~ 1.5)	3.2			
S 超耐熱合金(湿式) Superalloy (Wet) (Inconel 718)	-	40 (25 ~ 60)	0.15 (0.05 ~ 0.25)	2	0.2 (0.05 ~ 0.3)	2.4	0.25 (0.05 ~ 0.4)	3.2			
			チタン合金(湿式) Titanium Alloy (Wet) (Ti-6Al-4V)	-	80 (50 ~ 120)	0.2 (0.1 ~ 0.3)	2	0.25 (0.1 ~ 0.35)	2.4	0.3 (0.1 ~ 0.45)	3.2
H プリハードン鋼 Pre-hardened Steel (NAK80)	40~43HRC	120 (40 ~ 150)	0.15 (0.05 ~ 0.25)	1.5	0.2 (0.05 ~ 0.3)	1.5	0.25 (0.05 ~ 0.4)	1.5			
			ダイカスト用鋼 Steel for Die Casting (DAC-MAGIC, DH31)	43~48HRC	80 (40 ~ 120)	0.15 (0.05 ~ 0.25)	1	0.2 (0.05 ~ 0.3)	1	0.25 (0.05 ~ 0.4)	1
			調質鋼 Hardened Steel (SKD11)	50~55HRC	60 (30 ~ 90)	0.15 (0.05 ~ 0.25)	0.5	0.2 (0.05 ~ 0.3)	0.5	0.25 (0.05 ~ 0.4)	0.5

- ・上記条件表はショートシャンクタイプにおける推奨値となります。
- ・上記の数値は実切削速度における一般的な値を示したものです。加工環境に合わせて適宜調整して下さい。
- ・Above recommended speed is for Short Shank Type.
- ・The above cutting conditions are to be used as general guidelines. Adjustments may be necessary depending on actual cutting condition.

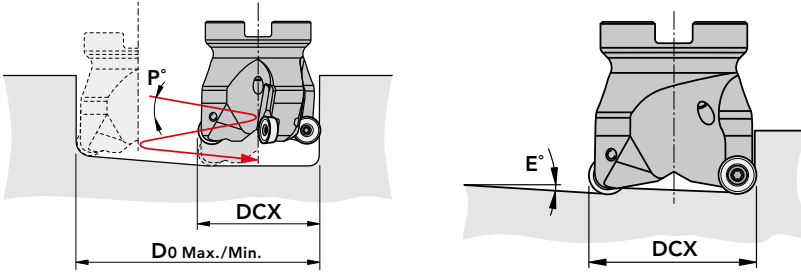

Maximum Ramping Angle (E)

■ランピング加工時の最大傾斜角(E) Maximum Ramping Angle (E)

インサートサイズ Insert Size	RPH*10...				RPH*12...				RPH*16...			
	ランピング角度 Ramping Angle E°	ヘリカル穴あけ Helical Milling (mm)		ヘリカル角度 Helical Angle P°	ランピング角度 Ramping Angle E°	ヘリカル穴あけ Helical Milling (mm)		ヘリカル角度 Helical Angle P°	ランピング角度 Ramping Angle E°	ヘリカル穴あけ Helical Milling (mm)		ヘリカル角度 Helical Angle P°
		最小径 Do Min.	最大径 Do Max.			最小径 Do Min.	最大径 Do Max.			最小径 Do Min.	最大径 Do Max.	
20	1.3	26	30	1.3	-	-	-	-	-	-	-	-
24	-	-	-	-	6.0	30	36	2.2	-	-	-	-
25	2.0	37	40	1.8	-	-	-	-	-	-	-	-
30	2.5	46	50	1.6	5.3	42	48	1.9	-	-	-	-
32	3.0	50	54	1.5	4.0	46	52	1.7	7.0	39	48	2.1
40	-	-	-	-	2.8	62	68	1.4	4.8	55	64	1.8
50	-	-	-	-	2.6	81	88	1.1	4.0	75	84	1.5
63	-	-	-	-	1.9	107	114	0.9	2.8	101	110	1.1
80	-	-	-	-	1.3	142	148	0.7	2.0	135	144	0.9
100	-	-	-	-	1.0	181	188	0.5	1.5	175	184	0.7

Cutting Data

加工データ Cutting Data

Inconel 718 (45HRC) の長寿命加工 Long-life milling of Inconel 718 (45HRC)

使用工具 Tool	PRC12R050M22-5 (φ50×5刃)	他社品 Competitor
使用インサート(材種) Insert (grade)	RPHT1204MOEN-SM (XC5035)	超硬コーティングインサート Coated Carbide Insert
被削材 Work Material	Inconel 718 (45HRC)	
切削速度 Cutting Speed	40m/min (255min ⁻¹)	60m/min (382min ⁻¹)
送り速度 Feed	270mm/min (0.21mm/t)	270mm/min (0.14mm/t)
切込深さ Depth of Cut	ap=0.5mm ae=30mm	
切削油剤 Coolant	水溶性切削油剤 Water-Soluble	
使用機械 Machine	横形マシニングセンタ(BT50) Horizontal Machining Center	
耐久 Durability	10m	2m

他社品では2m加工時点で大きく欠損し、さらには他コーナにも及び使用が出来ない状態となっている。それに対してPRCは10m加工可能であり、大幅に寿命UPをすることが出来た。

The competitor's tool broke extensively after milling 2m, and the damage extended to other corners, rendering the tool unusable. In contrast, the PRC was able to mill 10m, resulting in a considerably longer tool life.



2m加工後の写真 After 2m of milling

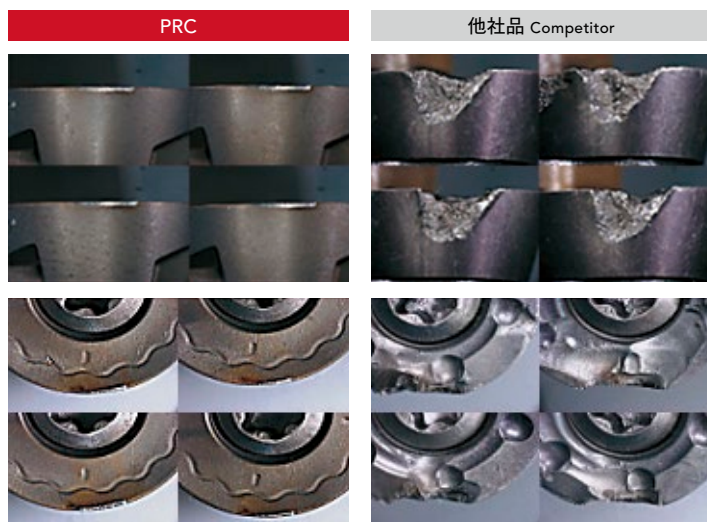

SUS304加工の長寿命化 Long tool life in SUS304

使用工具 Tool	PRC12R040SS32-3S (φ40×3刃)	他社品 Competitor
使用インサート(材種) Insert (grade)	RPHT1204MOEN-GL (XP2025)	超硬コーティングインサート Coated Carbide Insert
被削材 Work Material	SUS304	
切削速度 Cutting Speed	120m/min (955min ⁻¹)	
送り速度 Feed	860mm/min (0.3mm/t)	
切込深さ Depth of Cut	ap=3mm ae=24mm	
切削油剤 Coolant	水溶性切削油剤 Water-Soluble	
使用機械 Machine	横形マシニングセンタ(BT50) Horizontal Machining Center	

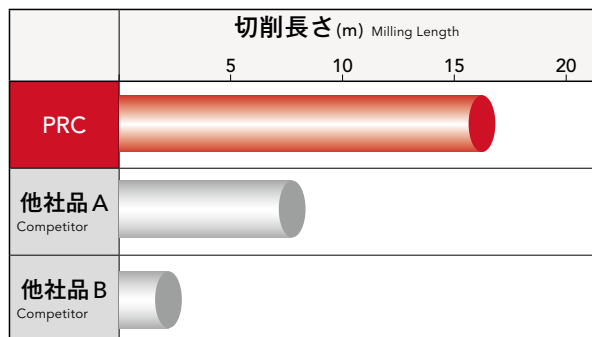

従来品では早期チッピング、摩耗進行により耐久が安定しなかった。PRC(XP2025)ではチッピング等も無く安定、耐久UPが可能となった。The PRC (XP2025) is able to achieve stable, chipping-free machining whereas the competitor tools had failed due to early chipping and wear.

Cutting Data

■加工データ Cutting Data

部品の荒取り加工(工具オリンピック) Rough milling of parts (Tool Olympics)

使用工具 Tool	PRC12R040SS32-3S (φ40×3刃)	他社品A、B Competitor
使用インサート(材種) Insert (grade)	RPHW1204MOSN (XC1015)	超硬コーティングインサート Coated Carbide Insert
被削材 Work Material	FC250	
切削速度 Cutting Speed	180m/min (1,433min ⁻¹)	
送り速度 Feed	2,300mm/min (0.5mm/t)	
切込深さ Depth of Cut	ap=3mm ae=25mm	
切削油剤 Coolant	なし(エアブロー) Air Blow	
使用機械 Machine	横形マシニングセンタ(BT50) Horizontal Machining Center	

部品の荒取り加工において各社比較を行った結果、じん性が高く耐摩耗性耐のあるインサートにより、他社品よりも3倍以上の耐久が得られた。

Each company's products were compared in the rough milling of parts. Having higher rigidity and wear resistance, our inserts provided three times the durability versus competitors'.

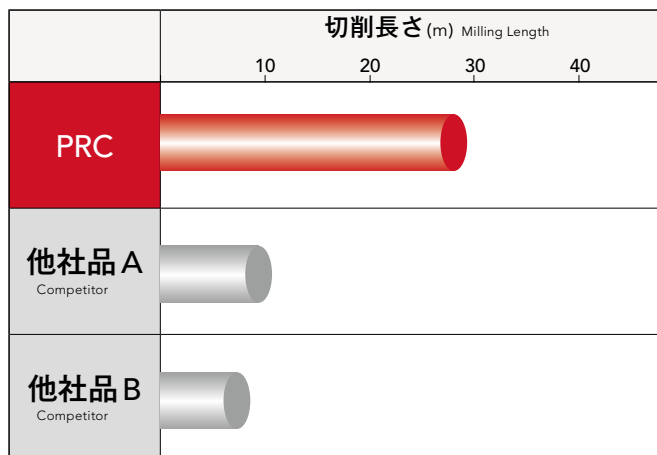

29m加工後のインサートの写真 After 29m of milling



ブレード荒取加工 Rough milling of blade

使用工具 Tool	PRC10R032SS32-4S (φ32×4刃)	他社品 Competitor
使用インサート(材種) Insert (grade)	RPHT10T3MOEN-SM (XC5035)	超硬コーティングインサート Coated Carbide Insert
被削材 Work Material	13Cr 相当品 Equivalent	
切削速度 Cutting Speed	90m/min (896min ⁻¹)	
送り速度 Feed	1,100mm/min (0.3mm/t)	
切込深さ Depth of Cut	ap=0.5mm ae=22mm	
切削油剤 Coolant	水溶性切削油剤 Water-Soluble	
使用機械 Machine	横形マシニングセンタ(BT40) Horizontal Machining Center	

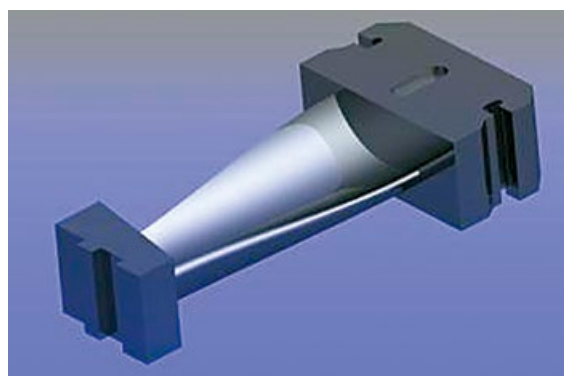

ブレード荒取り加工において耐久が1.5倍と安定した加工が可能であった。

In the rough milling with PRC, blade in a stable manner and durability was increased by 1.5 times versus the competition.

部品の荒取り加工 (工具オリンピック) Rough milling of parts (Tool Olympics)

使用工具 Tool	PRC12R050M22-5 (φ50×5刃)	他社品A、B、C、D Competitor
使用インサート(材種) Insert (grade)	RPHT1204MOEN-GL (XP2040)	超硬コーティングインサート Coated Carbide Insert
被削材 Work Material	SUS304	
切削速度 Cutting Speed	100m/min (637min ⁻¹)	
送り速度 Feed	800mm/min (0.25mm/t)	
切込深さ Depth of Cut	ap=1mm ae=25mm	
切削油剤 Coolant	水溶性切削油剤 Water-Soluble	
使用機械 Machine	横形マシニングセンタ (BT50) Horizontal Machining Center	

部品の荒取り加工において各社比較を行った結果、他社品は早期にてチッピング・欠損などが発生したが、PRCは正常摩耗でさらに他社品Aに対し、耐久1.7倍以上となった。

Each company's products were compared in the rough milling of parts. Competitors' tools resulted in premature chipping and breakage, but the PRC wore normally, resulting in 1.7 times the durability versus Competitors.

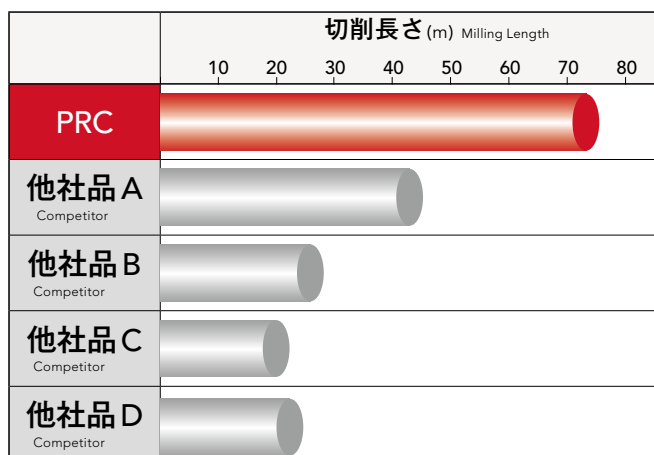

67.2m 加工後のインサートの写真 After 67.2m of milling

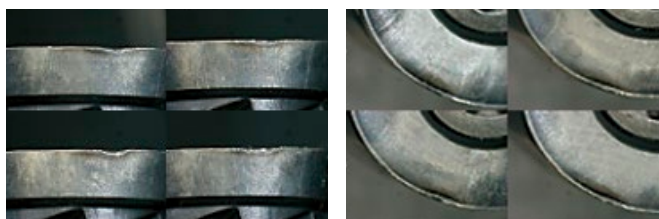

» Phoenix PDR

高送りラジアスカッターシリーズ
High Feed Radius Cutter Series

Phoenix Deep feed Radius



■ 従来加工の問題解決

Solves traditional machining problems

従来の高能率工具の問題点

Issues with traditional high-efficiency cutting tools

- 切込みが大きくできるラジアスががない
There is not enough radius tool that can perform large depths of cut.
- 表皮の取り代変化が大きく工具が破損してしまう
Large variances in removal damage the tool.
- 黒皮部分では切込み量が少ないためにエアカットが多くなってしまふ
The depth of cut is so small for black surface areas that air cutting becomes common.



切込みが必要だけど…
能率は落としたいくない。

More cutting depth is needed without dropping the efficiency...

低切込み高送りラジアス
荒取り主流工具
Leading low depth of cut,
high feed radius roughing tools.

刃先剛性を考えた 可変ネガチャンファ形状

Variable negative form for edge rigidity

→ 欠け防止

→ prevent breakage

ねじれ刃形

Spiral tool form

→ 切削抵抗ダウン

→ reduce cutting force



ざらい刃により
仕上加工に対応した刃形
A cutting tool capable of finish
milling, thanks to the wiping edge

切込み量2～5mmの時に最適な
インサート形状(コーナR10)
Ideal insert formation for depth of cut
between 2-5mm (corner radius 10)

側面加工に対応した刃形
A cutting tool capable of side
machining

ダブルクランプ採用
Uses double clamping

底部逃がし(3.5mm)
により鑄肌ムラに対応
Bottom relief (3.5mm)
prevents
rough surfaces

バックメタルを
大きくすることによりボディ剛性
アップ
Body rigidity has been
increased because of the
enlarged back metal

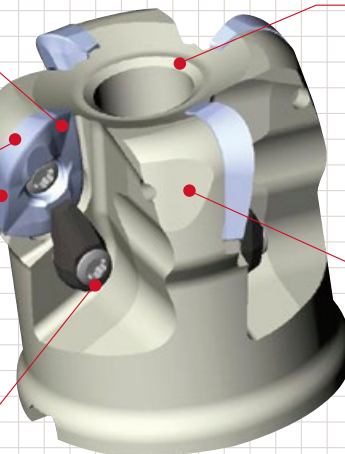

■ ボールの働き、ラジアスが斬る!

The work of a ball, cut by a radius!

今までボールの仕事と思っていた加工も
PDRなら斬れます。

The PDR can cut which was considered the work of ball end mills until now.

大荒取り(等高線加工)で、切込み量増により加工段差が大きくなります。通常では、次工具に与える影響が大きくなり加工工程間では最終的に時間が増大するのでは、と懸念されます。しかし、PDRは取り代増による残り代をボール的な役割を果たす刃型設計により、ラジアスの有効的な工具剛性を保ったまま走査線加工が可能です。等高線の荒取りがap3mm以下の場合に限りです。また、φ50以下を推奨します。

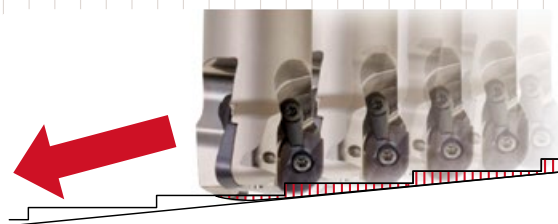

In heavy roughing (contoured machining), machining steps become larger based on the depth of cut. Usually, the effect on the next cutting tool is great, and as machining processes are added, the overall production time increases. However, the tool form of the PDR is designed to increase the removal and leave stepovers similar to ball end mills while still maintaining the rigidity of a radius end mill. Roughing of contoured lines is restricted to ap3mm. Also, a diameter of φ50 or less is recommended.

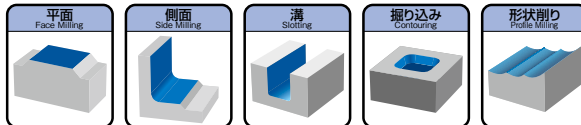

Specification

■形状寸法表 Specification

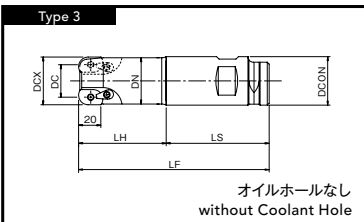
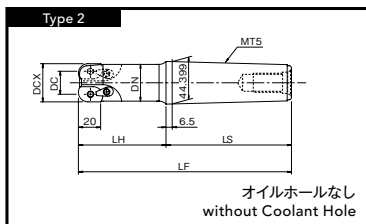
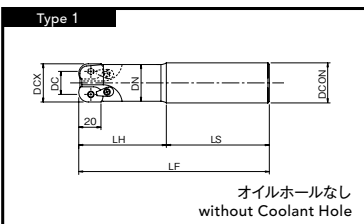

単位:mm Unit:mm

ツールNo. EDP No.	呼び Designation	カッタ 外径 DCX	外径 DC	刃数 ZEPF	シャンク径 DCON	全長 LF	首下長 LH	首径 DN	シャンク 長 LS	重量 (kg)	形状 タイプ Type	標準価格 (Yen)
7800000	PDR20R040SS42-2S	40	20	2	42	150	50	38.9	100	1.46	1	51,800
7800001	PDR20R040MT5M16-2S	40	20	2	MT5-M16	256	120	38.9	136	2.48	2	78,200
7800003	PDR20R040MT5M24-2S	40	20	2	MT5-M24	256	120	38.9	136	2.3	2	78,200
7800009	PDR20R040SS42-2L	40	20	2	42	250	150	38.9	100	2.44	1	70,700
7800010	PDR20R040MT5M16-2L	40	20	2	MT5-M16	306	170	38.9	136	2.97	2	94,200
7800012	PDR20R040MT5M24-2L	40	20	2	MT5-M24	306	170	38.9	136	2.82	2	94,200
7800004	PDR20R050SS42-3S	50	30	3	42	150	50	48.5	100	1.55	1	70,600
7800008	PDR20R050CN50.8-3S	50	30	3	CN50.8	150	65	48.5	85	2.05	3	81,900
7800005	PDR20R050MT5M16-3S	50	30	3	MT5-M16	256	120	48.5	136	2.92	2	96,900
7800007	PDR20R050MT5M24-3S	50	30	3	MT5-M24	256	120	48.5	136	2.71	2	96,900
7800013	PDR20R050SS42-3L	50	30	3	42	250	150	48.5	100	3.03	1	86,100
7800017	PDR20R050CN50.8-3L	50	30	3	CN50.8	250	165	48.5	85	3.5	3	99,200
7800014	PDR20R050MT5M16-3L	50	30	3	MT5-M16	306	170	48.5	136	3.63	2	111,000
7800016	PDR20R050MT5M24-3L	50	30	3	MT5-M24	306	170	48.5	136	3.49	2	111,000

Phoenix

高送りラジアスカッタ ボアタイプ

High Feed Radius Cutter with Bore Type

PDR BORE

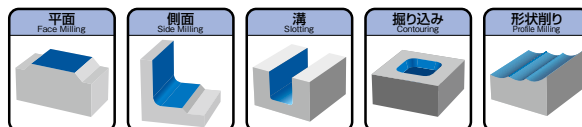

Specification

■形状寸法表 Specification

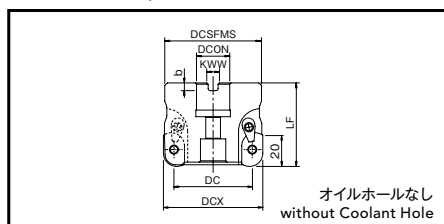

単位:mm Unit:mm

ツールNo. EDP No.	呼び Designation	カッタ 外径 DCX	外径 DC	刃数 ZEPF	カッタ 高さ LF	ボス径 DCSFMS	穴径 DCON	端面キー溝 Key Slot		重量 (kg)	標準価格 (Yen)
								幅 KWW	深さ b		
7800057	PDR20R063M22-3	63	43	3	63	60	22	10.4	6.3	0.97	65,000
7800050	PDR20R063M22.2-3	63	43	3	63	60	22.225	8.4	5	0.97	65,000
7800058	PDR20R063M22-4	63	43	4	63	60	22	10.4	6.3	0.88	78,600
7800051	PDR20R063M22.2-4	63	43	4	63	60	22.225	8.4	5	0.88	78,600
7800059	PDR20R080M27-4	80	60	4	63	76	27	12.4	7	1.6	106,000
7800052	PDR20R080M31.7-4	80	60	4	63	76	31.75	12.7	8	1.49	106,000
7800060	PDR20R080M27-5	80	60	5	63	76	27	12.4	7	1.51	120,000
7800053	PDR20R080M31.7-5	80	60	5	63	76	31.75	12.7	8	1.39	120,000
7800054	PDR20R100M31.7-5	100	80	5	63	96	31.75	12.7	8	2.55	136,000
7800061	PDR20R100M32-5	100	80	5	63	96	32	14.4	8	2.56	136,000
7800055	PDR20R100M31.7-6	100	80	6	63	96	31.75	12.7	8	2.46	160,000
7800062	PDR20R100M32-6	100	80	6	63	96	32	14.4	8	2.46	160,000
7800056	PDR20R125M31.7-6	125	105	6	63	100	31.75	12.7	8	3.78	178,000
7800063	PDR20R125M40-6	125	105	6	63	100	40	16.4	9	3.58	178,000

Inserts

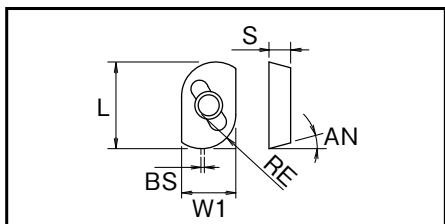

■適用インサート Inserts

単位:mm Unit:mm

呼び Designation	切れ刃数 No. of Cutting Edges	インサート寸法 Insert Size					ざらい刃(副切れ刃) BS	コーティング材種 Grade of Coated Materials	標準価格 (Yen)
		L×W1	厚さ S	逃げ角 AN	RE				
ADMT2006100PDR-GM	2	24.18×16	6.35	15°	10	1	XP3930	7810000	2,750

Accessories

■部品 Accessories

	ツールNo. EDP No.	呼び Designation
クランプねじ Clamping Screw	7808001	CSPB-5 (Torx 20IP)
押え金セット (押え金、ワッシャー、クランプねじ) Clamping set (clamp, washer, and clamping screw)	7808002	CSY-20

	ツールNo. EDP No.	呼び Designation	標準価格 (Yen)
T型レンチ T-Wrench	7808000	20IP-T (Torx 20IP)	2,520

レンチは別途ご購入下さい。 The wrenches are sold separately from the cutters.

Phoenix

高送りラジラスカッタシリーズ
High Feed Radius Cutter Series

PDR

被削材別推奨材質

Recommended Materials by Insert Type

◎第一推奨材質 Best
○第二推奨材質 Good

インサート材種 Insert Grades	ブレーカ Insert Breaker	切削油剤 Coolant	P	M	K	N	S	H
XP3930	GM	無 Dry	◎		◎			

GM:汎用 GM:General use

Cutting Conditions

切削条件基準表 Cutting Conditions

被削材 Work Material	引張強さ・硬さ Tensile Strength・ Hardness	切削速度 Vc (m/min) Cutting Speed	PDR SS/MT/CN			PDR BORE				
			一刃当たりの送り量 fz (mm/t) Feed per Tooth	切込深さ ap (mm) Depth of Cut		一刃当たりの送り量 fz (mm/t) Feed per Tooth	切込深さ ap (mm) Depth of Cut			
				120	170		100	200	300	400
P 軟鋼、低炭素鋼 Mild Steel, Low Carbon Steel (SS400, S10C) 炭素鋼、合金鋼 Carbon Steel, Alloy Steel (S50C, SCM440) ダイス鋼 Die Steel (SKD11, SKD61)	~180HB	180(90 ~ 220)	0.7(0.3 ~ 1)	3	2	0.6(0.3 ~ 1)	3	3	2	2
	~280HB	180(90 ~ 220)	0.7(0.3 ~ 1)	3	2	0.6(0.3 ~ 1)	3	3	2	2
	~280HB	150(90 ~ 180)	0.6(0.3 ~ 1)	3	2	0.5(0.3 ~ 1)	3	2	2	2
K 鋳鉄 Cast Iron (FC250) ダクタイル鋳鉄 Ductile Cast Iron (FCD400)	~350N/mm ²	180(100 ~ 250)	0.8(0.3 ~ 1.5)	3	3	0.7(0.3 ~ 1.5)	3	3	2	2
	~800N/mm ²	150(100 ~ 250)	0.7(0.3 ~ 1.2)	3	3	0.6(0.3 ~ 1.2)	3	3	2	2

上記の数値は実切削速度における一般的な値を示したものです。加工環境に合わせて適宜調整して下さい。
The above cutting conditions are to be used as general guidelines. Adjustments may be necessary depending on actual cutting condition.

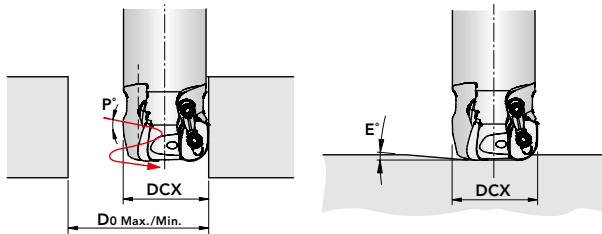

Maximum Ramping Angle (E)

ランピング加工時の最大傾斜角(E) Maximum Ramping Angle (E)

カッタ外径 (mm) DCX	ランピング角度 Ramping Angle E°	ヘリカル穴あけ Helical Milling (mm)		ヘリカル角度 Helical Angle P°	Z軸 突込み Plunging (mm)
		最小径 Do Min.	最大径 Do Max.		
40	5	50	78	1.4	3
50	3	70	98	1.1	3
63	2	96	124	0.9	3
80	1	130	158	0.7	3
100	0.5	170	198	0.5	3
125	0.5	220	248	0.4	3

1. 切削始めに長い切りくずが発生するのでご注意ください。
2. 送りは基準条件表の40~70%で設定して下さい。
3. 送り速度を落とさずに進入する場合は角度1°以下で設定して下さい。
4. エアブローでの使用を推奨します。
1. Long chips may occur in the beginning of the milling process.
2. Feed rate should be set within 40-70% of the recommended milling condition.
3. To advance without dropping the feed rate, set an angle of less than 1°.
4. Using air blow is highly recommended.

Cutting Data

加工データ Cutting Data

刃先剛性と切れ味を両立させた刃形設計 Cutting edge is designed for both rigidity and sharpness

使用工具 Tool	PDR20R050MT5M16-3L (φ50×3刃)
使用インサート(材種) Insert (grade)	ADMT2006100PDR-GM (XP3930)
被削材 Work Material	FC250
切削速度 Cutting Speed	150m/min (955min ⁻¹)
送り速度 Feed	1,500mm/min (0.52mm/t)
切込深さ Depth of Cut	a _p =3mm a _e =25mm
切削油剤 Coolant	なし(エアブロー) Air Blow
使用機械 Machine	立形マシニングセンタ(8.5/11kW) Vertical Machining Center

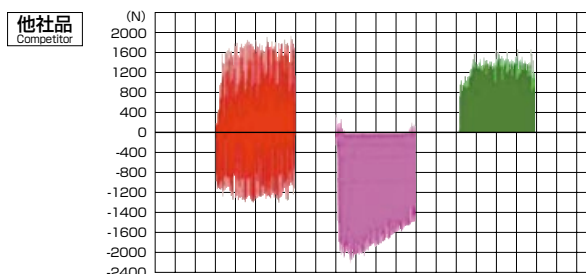
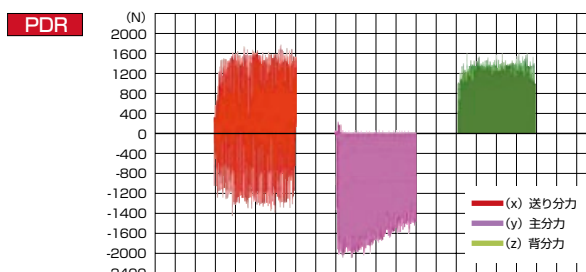

(単位: N) (unit: N)

	x送り分力 Feed force	y主分力 Principal cutting force	z背分力 Thrust force	合力 Resultant force
PDR	1651	2082	1433	3019
他社品(ブレーカ有) Competitor (with breaker)	1725	2095	1455	3079

強化刃形を採用するも、合力はブレーカ有並み!
With the strengthened cutting edge, resultant force is as with a breaker!

機械主軸用電動機(出力)を有効利用するには... Using the spindle load meter more effectively

切削速度 Cutting Speed	150m/min
切込深さ Depth of Cut	a _p =3mm a _e =(Dc-20)+5 (切込み3mm工具径) Tool diameter for 3mm cut depth

PDRは2~5mm切込みを推奨しております。
そのため機械主軸用電動機(出力)との関連性が大きくなります。
機械主軸用電動機(出力)に合わせた工具径選定、条件選定を行って下さい。
For PDR, a 2-5mm of depth of cut is recommended. This is largely related to the spindle load meter.
Please select the tool diameter and cutting conditions that are suited to your spindle load meter.

FC250機械主軸用電動機(出力)目安表

Spindle load meter reference table

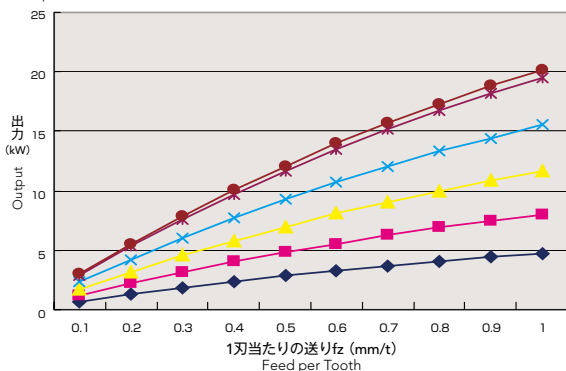

S50C機械主軸用電動機(出力)目安表

Spindle load meter reference table

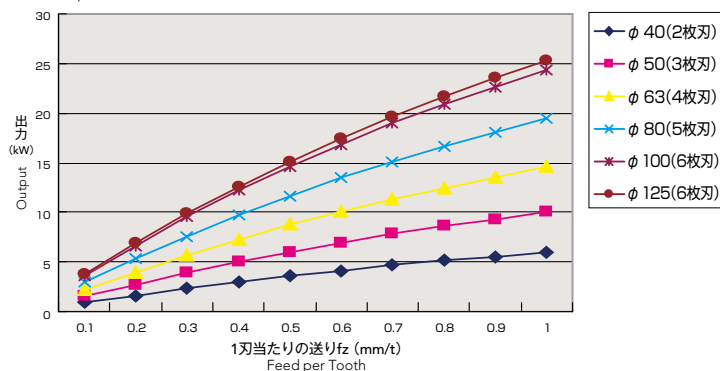

Cutting Data

■加工データ Cutting Data

加工効率アップ+長寿命を達成 Achieving efficient machining and longer tool life

使用工具 Tool	PDR20R050MT5M24-3S (φ50×3刃)
使用インサート(材種) Insert (grade)	ADMT2006100PDR-GM (XP3930)
被削材 Work Material	FC250
加工ワーク Work	プレス金型 Press Dies
切削速度 Cutting Speed	150m/min (955min ⁻¹)
送り速度 Feed	2,000mm/min (0.7mm/t)
切込深さ Depth of Cut	a _p =3mm a _e =30mm
切削油剤 Coolant	なし(エアブロー) Air Blow
使用機械 Machine	門形マシニングセンタ(18.5/22kW) Double Column Machining Center
耐久時間 Durability	4時間 Hours

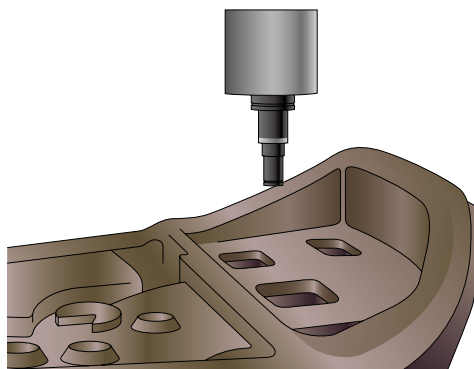

ボールと比較して能率2倍でありながら、主軸負荷値を低減!主軸最大負荷55%。
While efficiency is twice as great as ball end mills, spindle loads are also reduced! The maximum spindle load is 55%.

高能率加工実現 Highly efficient machining

使用工具 Tool	PDR20R040MT5M24-2S (φ40×2刃)
使用インサート(材種) Insert (grade)	ADMT2006100PDR-GM (XP3930)
被削材 Work Material	ミーハナイト鋳鉄 Meehanite Cast Iron
加工ワーク Work	プレス金型 Press Dies
切削速度 Cutting Speed	170m/min (1,350min ⁻¹)
送り速度 Feed	2,430mm/min (0.9mm/t)
切込深さ Depth of Cut	a _p =3mm a _e =20mm
切削油剤 Coolant	なし(エアブロー) Air Blow
使用機械 Machine	門形マシニングセンタ(18.5/22kW) Double Column Machining Center
加工時間 Machining Time	4時間 Hours

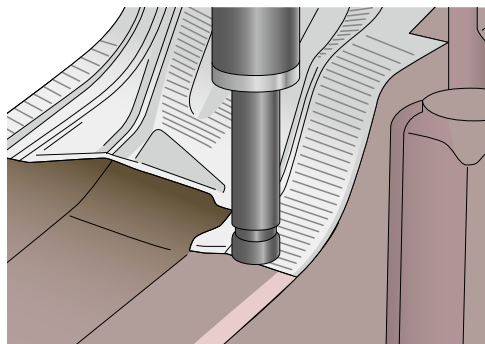

他社品の送り速度は1,500mm/minであった。PDRは加工時間4時間で工具損傷無く安定した加工が可能であった。
The feed rate was 1,500mm/min for the competitor's tool. The machining time of PDR was 4 hours with stable machining without tool damage.

切込み量増による能率アップ実現 Increased efficiency by the depth of cut increases

使用工具 Tool	PDR20R050SS42-3S (φ50×3刃)
使用インサート(材種) Insert (grade)	ADMT2006100PDR-GM (XP3930)
被削材 Work Material	S50C
加工ワーク Work	樹脂型 Plastic Dies
切削速度 Cutting Speed	150m/min (955min ⁻¹)
送り速度 Feed	3,000mm/min (1mm/t)
切込深さ Depth of Cut	a _p =3mm a _e =30mm
突出し量 Overhang Length	100mm
切削油剤 Coolant	なし(エアブロー) Air Blow
使用機械 Machine	横形マシニングセンタ(37/45kW) Horizontal Machining Center
加工時間 Machining Time	2時間 Hours

現状工具と比較して能率は1.5倍となった。

Efficiency was improved 1.5 times compared to current tools.

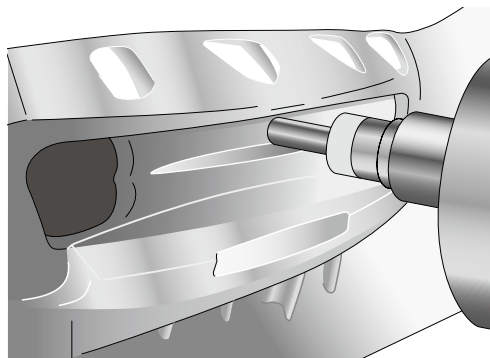

» Phoenix PFAL



アルミ用仕上げカッタ
Finishing Cutter for Aluminum

Phoenix Finishing Cutter for Aluminum

■ アルミボディで驚きの軽さを実現 → 小型マシニングセンタでも使用できる豊富なサイズラインナップ

Incredibly Lightweight with Aluminum Body Construction

→ Broad size lineup to accommodate various cutting environment, even small machining centers.

高バランス Excellent Balance

- ・高速回転加工を実現
 - ・カッタ単体(ブレード装着済み)でバランス等級G6.3を保証
- Enables high-speed milling
Cutter (with blades mounted) with guaranteed balancing grade to G6.3

高能率 High Efficiency

- ・多刃仕様およびワイパーブレード標準採用で高送り加工でも仕上げ面良好
- Excellent surface finish even in high-feed milling with adoption of multiple blades and wiper blade standardization

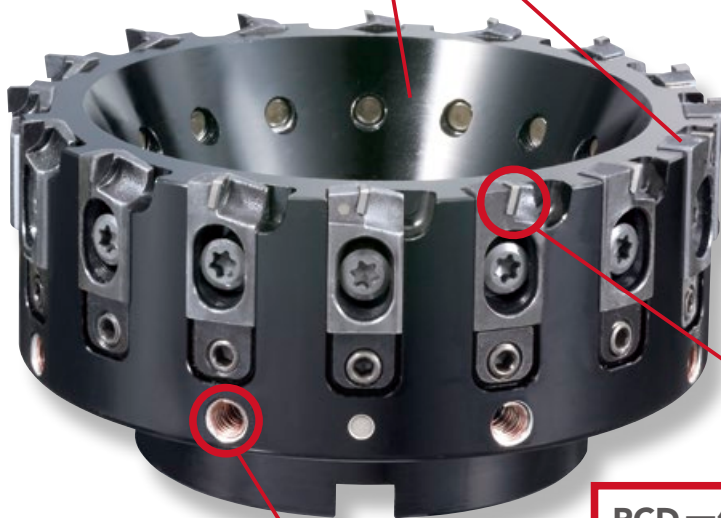

高精度バランス調整 High Precision Balancing

- ・カッタをアーバに取り付けた状態の高精度なバランス調整も可能
- High precision balancing can be performed even when cutter is mounted onto the arbor

PCD 一体型ブレード

- PCD Integrated Blades
- ・再研磨可能で高いコストパフォーマンス
- PCD can be reground for maximum cost performance

■ BT30でPFAL φ160が使用可能 PFAL φ160 with BT30

φ160に穴径φ25.4、27を標準ラインナップ

Bore diameters of φ25.4 and 27 are standard offering in the PFAL φ160 cutter lineup.

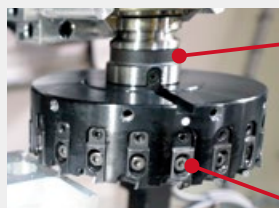

フェイスミルアーバ Face Mill Arbor

BT30-FMA25.4-45

重量 0.90kg

Weight

+

PFAL φ160 刃数(z)20

PFAL04R160M25.4-20

重量 1.98kg

Weight

=

総重量
Total Weight

2.88kg

加工データはp.193をご参照下さい。 Please see p.193 for cutting data.

Features

■特長 Features

■ 少ない部品数で工具管理とセッティングが容易

Few Required Components Makes Easy Setup and Simple Tool Management

○ワイパーブレード標準採用 Standardized Wiper Blade



ワイパーブレード装着マーク
Wiper Blade Position Indicator

ワイパー認識マーク
Wiper Blade Indicator



ワイパーブレード Wiper Blade

- 優れた加工面粗さを実現
Enables superior surface finish
- 1つのボディにつき1枚、装着マーク部分に取り付け
One wiper blade per cutter body; for mounting in the designated position
- ブレードにもワイパー認識マーク付き
Wiper blade also comes with identifiable indicator



ノーマルブレード Normal Blade

- 多刃でも安定した加工が可能
Enables stable milling with multiple blades configuration
- 装着マーク部分以外はノーマルブレードを取り付け
For mounting in any cutter body slots with exception of wiper blade position

○全ボディサイズ共通の部品を採用 Spare Accessories Compatible with All Cutter Sizes



ブレード用クランプねじ
Clamping Screw for Blade

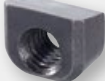

ウェッジ
Wedge



ウェッジ用クランプねじ
Clamping Screw for Wedge

- サイズの大きいクランプねじ(M6)で剛性アップ
Improved rigidity with large size clamping screw (M6)
- 容易な刃先調整でセッティング時間短縮
Easy cutting edge adjustment reduces required setup time

刃先高さ調整手順はp.195、p.196をご参照下さい。
Please see p.195 and p.196 for cutting edge height adjustment instructions.

■ 主な加工部品例 PFAL Component Solution Examples

自動車アルミ部品

Aluminum Components in Automotive

- クラッチハウジング
Clutch Housing
- ミッションケース
Transmission Case
- シリンダヘッド
Cylinder Head
- シリンダブロック
Cylinder Block
- その他、あらゆるアルミ部品
And more

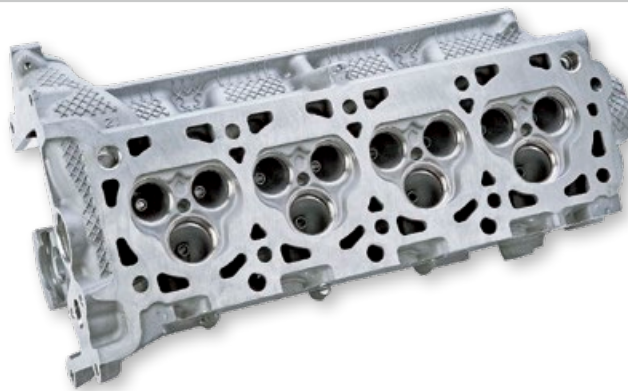

Phoenix

アルミ用仕上げカッタ ボアタイプ
Finishing Cutter for Aluminum, Bore Type

PFAL BORE

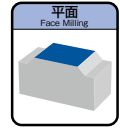

Specification

■形状寸法表 Specification

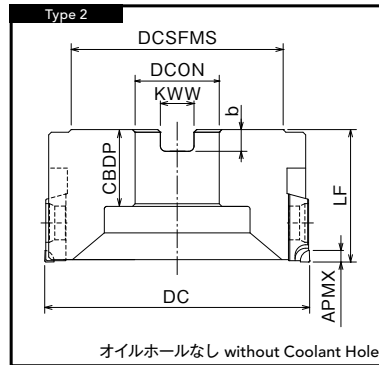
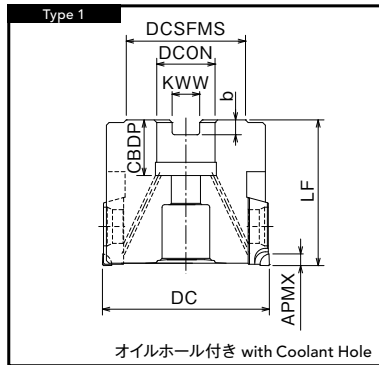

Type2: 内部クーラントを使用する際は市販のクーラント穴付きクランプボルトをご使用下さい。
For the use of internal coolant, please use a clamping bolt with coolant holes sold in the market.

単位:mm Unit:mm

ツールNo. EDP No.	呼び Designation	外径 DC	刃数 ZEFP	カッタ 高さ LF	取付け穴 高さ CBDP	ボス径 DCSFMS	穴径 DCON	端面キー溝 Key Slot		最高回転数 RPMX (min ⁻¹)	重量 (kg)	形状 タイプ Type	標準価格 (Yen)
								幅 KWW	深さ φ				
7803600	PFAL04R050M16-5	50	5	55	20	40	16	8.4	5.6	32,000	0.27	1	96,300
7803601	PFAL04R063M22-6	63	6	55	21	45	22	10.4	6.3	25,000	0.4	1	122,000
7803602	PFAL04R063M22-8	63	8	55	21	45	22	10.4	6.3	25,000	0.43	1	132,000
7803603	PFAL04R080M25.4-8	80	8	50	28	70	25.4	9.5	6	19,800	0.53	2	154,000
7803604	PFAL04R080M27-8	80	8	50	28	70	27	12.4	7	19,800	0.52	2	154,000
7803605	PFAL04R080M25.4-10	80	10	50	28	70	25.4	9.5	6	19,800	0.55	2	160,000
7803606	PFAL04R080M27-10	80	10	50	28	70	27	12.4	7	19,800	0.54	2	160,000
7803607	PFAL04R100M25.4-8	100	8	50	28	80	25.4	9.5	6	15,800	0.86	2	192,000
7803608	PFAL04R100M27-8	100	8	50	28	80	27	12.4	7	15,800	0.83	2	192,000
7803609	PFAL04R100M31.7-8	100	8	50	32	80	31.75	12.7	8	15,800	0.86	2	192,000
7803610	PFAL04R100M32-8	100	8	50	28	80	32	14.4	8.2	15,800	0.78	2	192,000
7803611	PFAL04R100M25.4-12	100	12	50	28	80	25.4	9.5	6	15,800	0.9	2	219,000
7803612	PFAL04R100M27-12	100	12	50	28	80	27	12.4	7	15,800	0.87	2	219,000
7803613	PFAL04R100M31.7-12	100	12	50	32	80	31.75	12.7	8	15,800	0.9	2	219,000
7803614	PFAL04R100M32-12	100	12	50	28	80	32	14.4	8.2	15,800	0.82	2	219,000
7803615	PFAL04R125M25.4-10	125	10	50	28	80	25.4	9.5	6	12,600	1.35	2	252,000
7803616	PFAL04R125M27-10	125	10	50	28	80	27	12.4	7	12,600	1.33	2	252,000
7803617	PFAL04R125M38.1-10	125	10	63	36	80	38.1	15.9	10	12,600	1.3	2	252,000
7803618	PFAL04R125M40-10	125	10	63	30	85	40	16.4	9.2	12,600	1.26	2	252,000
7803619	PFAL04R125M25.4-16	125	16	50	27	80	25.4	9.5	6	12,600	1.42	2	286,000
7803620	PFAL04R125M27-16	125	16	50	28	80	27	12.4	7	12,600	1.41	2	286,000
7803621	PFAL04R125M38.1-16	125	16	63	36	80	38.1	15.9	10	12,600	1.38	2	286,000
7803622	PFAL04R125M40-16	125	16	63	30	85	40	16.4	9.2	12,600	1.33	2	286,000
7803623	PFAL04R160M25.4-12	160	12	50	28	80	25.4	9.5	6	10,000	1.98	2	320,000
7803624	PFAL04R160M27-12	160	12	50	28	80	27	12.4	7	10,000	1.98	2	320,000
7803625	PFAL04R160M40-12	160	12	63	30	85	40	16.4	9.2	10,000	2.1	2	320,000
7803626	PFAL04R160M50.8-12	160	12	63	38	100	50.8	19.1	11	10,000	2.15	2	320,000
7803629	PFAL04R160M25.4-20	160	20	50	28	80	25.4	9.5	6	10,000	1.98	2	354,000
7803630	PFAL04R160M27-20	160	20	50	28	80	27	12.4	7	10,000	1.98	2	354,000
7803627	PFAL04R160M40-20	160	20	63	30	85	40	16.4	9.2	10,000	2.2	2	354,000
7803628	PFAL04R160M50.8-20	160	20	63	38	100	50.8	19.1	11	10,000	2.24	2	354,000

- ・測定器による刃先高さの調整を行って下さい。
- ・APMXについてはブレードのLE欄をご確認下さい。(p.192)
- ・上記価格はブレードを含まないカッタ単体の価格です。
- ・重量はブレード装置時の総重量です。

- Adjust cutting edge height with a tool presetter.
- For APMX, please refer to the LE column of the blade table.(p.192)
- Prices listed above are for the single unit cutter body without blades.
- The weight show on above is the total weight of cuttuer body with all baldes mounted.

Blade

・ワイパーブレードは1ボディにつき1枚、装着マーク部分に取り付けて下さい。
One wiper blade is required per cutter body and should be mounted in the designated position.
・ブレード(ノーマル/ワイパー)発注単位は1個となります。
Order unit for blade (normal/wiper) = 1 piece

■ノーマルブレード Normal Blade

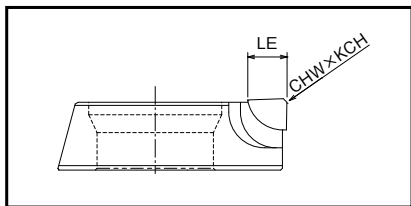

アルミの油口部分の加工に最適な
切れ刃長(αp) 6mmタイプもラインナップ。(FR1206)
Blade with 6mm cutting edge width (FR1206) suitable for
milling of aluminum pouring gates is also available.

呼び Designation	ブレード寸法 Blade Size			PCD材種 PCD Grade DP010	標準価格 (Yen)
	切れ刃数 Number of Cutting Edges	コーナ形状 CHW×KCH	LE (mm)		
FR1204	1	0.4×45°	4	7820500	11,300
FR1206	1	0.4×45°	6	7820502	14,300

■ワイパーブレード Wiper Blade

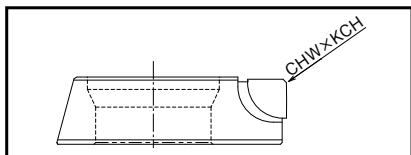

ワイパーブレード(FR1204-W)は
FR1204・FR1206問わず共通で使用可能です。
The FR1204-W wiper blade can be used with both the
FR1204 and FR1206 normal blades.

呼び Designation	ブレード寸法 Blade Size		PCD材種 PCD Grade DP010	標準価格 (Yen)
	切れ刃数 Number of Cutting Edges	コーナ形状 CHW×KCH		
FR1204-W	1	0.4×45°	7820501	15,600

Accessories

■部品 Accessories

呼び Designation	ツールNo. EDP No.	呼び Designation
ブレード用クランプねじ Clamping Screw for Blade	7808125	FS60620 (Torx25)
ウェッジ Wedge	7808143	W12-06
ウェッジ用クランプねじ Clamping Screw for Wedge	7808142	WS0617

呼び Designation	ツールNo. EDP No.	呼び Designation
T型レンチ (ブレード用クランプねじ用) T-Wrench (for blade clamp screw)	7808211	T25-T
L型レンチ (ウェッジ用クランプねじ用) L-Wrench (for wedge screw)	7808231	3MM-L

部品は全て(レンチ含む)本体付属となります。
All accessories (including wrenches) come with the cutter body.

Cutting Conditions

■切削条件基準表 Cutting Conditions

被削材 Work Material	成分 Component	材質記号 Material Symbol	用途 Application	切削速度 Vc (m/min) Cutting Speed		1刃当りの送り量 fz (mm/t) Feed per Tooth	切込深さ ap (mm) Depth of Cut
				BT30	BT40, BT50 HSK-63		
Z アルミニウム合金 Aluminum Alloy	~12% Si	A7075・A5052・A2017他 ADC12他 etc.	中仕上 Semi-finishing	1,000 (800~2,000)	2,000 (1,000~5,000)	0.08 (0.05 ~ 0.10)	1.5 (1.0 ~ 2.0)
			仕上 Finishing				
	13% Si ~	AC9A・AC9B他 etc.	中仕上 Semi-finishing	600 (400~800)	0.08 (0.05 ~ 0.10)	1.5 (1.0 ~ 2.0)	
			仕上 Finishing				0.06 (0.05 ~ 0.08)

在庫区分は全てC(標準在庫品)となります。 Stock are categorized as C (Standard stock item).

Cutting Data

■加工データ Cutting Data

BT30でφ160使用による高能率加工 High efficiency milling on BT30 with PFAL φ160

使用工具 Tool	PFAL04R160M25.4-20 (φ160×20刃) Flutes	
用途 Application	中仕上げ Semi-finishing	仕上げ Finishing
被削材 Work Material	ADC12	
切削速度 Cutting Speed	1,000m/min (2,000min ⁻¹)	2,000m/min (4,000min ⁻¹)
送り速度 Feed	3,200mm/min (0.08mm/t)	6,400mm/min (0.08mm/t)
切込深さ Depth of Cut	ap=2mm ae=100mm	ap=0.2mm ae=100mm
切削油剤 Coolant	水溶性切削油剤 Water-Soluble	
使用機械 Machine	立形マシニングセンタ(BT30) Vertical Machining Center	
加工面粗さ Surface Roughness	Ra=0.25μm Rz=1.22μm	Ra=0.12μm Rz=0.96μm



大径カッタを用いることでカッタバスの継ぎ目の無い加工面が得られた。BT30の小型マシニングセンタを使用しても、中仕上げ、仕上げ共に安定した加工が行え良好な加工面を得ることが出来た。

The use of a large-diameter cutter allows processing of a wide area in one pass with no overlap marks. Stable and high quality surface finish was achieved for semi-finishing and finishing even in small machining centers such as the BT30.

アルミ部品の高精度加工 High precision milling of aluminum component

使用工具 Tool	PFAL04R080M25.4-10 (φ80×10刃) Flutes	他社品 (φ80×6刃) Competitor Flutes
被削材 Work Material	ADC12	
切削速度 Cutting Speed	3,000m/min (12,000min ⁻¹)	
送り速度 Feed	14,400mm/min (0.12mm/t)	7,200mm/min (0.1mm/t)
切込深さ Depth of Cut	ap=0.5mm ae=53mm	
切削油剤 Coolant	水溶性切削油剤 Water-Soluble	
使用機械 Machine	横形マシニングセンタ(BT40) Horizontal Machining Center	

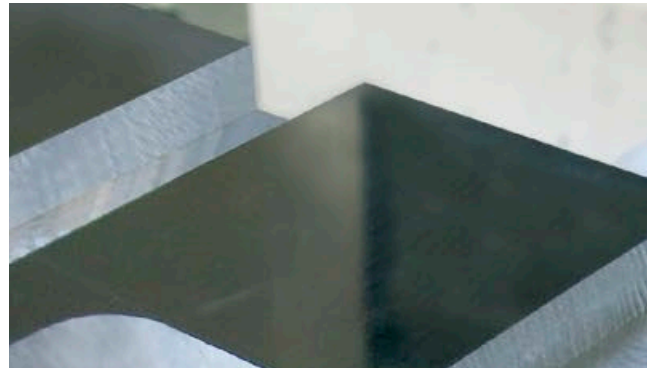

加工面粗さ Surface Roughness
Ra=0.17 ~ 0.22μm Rz=1.08 ~ 1.24μm

多刃仕様のカッタを使用することで加工能率が2倍となり、びびりもなく良好な加工面を得る事が出来た。

The PFAL cutter had doubled milling efficiency with no chattering, enabling an excellent surface finish.

アルミ部品の高効率・高精度加工 High efficiency and high precision milling of aluminum component

使用工具 Tool	PFAL04R063M22-6 (φ63×6刃) Flutes	
用途 Application	中仕上げ Semi-finishing	仕上げ Finishing
被削材 Work Material	ADC12	
切削速度 Cutting Speed	1,000m/min (5,000min ⁻¹)	1,500m/min (7,500min ⁻¹)
送り速度 Feed	3,000mm/min (0.1mm/t)	4,500mm/min (0.1mm/t)
切込深さ Depth of Cut	a _p =2mm a _e =34mm	a _p =0.2mm a _e =34mm
切削油剤 Coolant	水溶性切削油剤 Water-Soluble	
使用機械 Machine	横形マシニングセンタ(BT30) Horizontal Machining Center	
加工面粗さ Surface Roughness	Ra=0.08μm Rz=0.7μm	Ra=0.05μm Rz=0.3μm

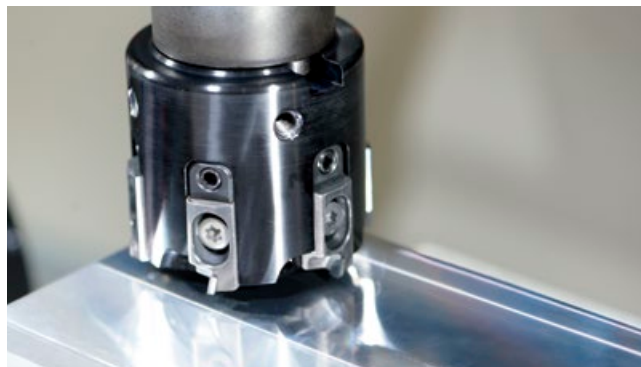
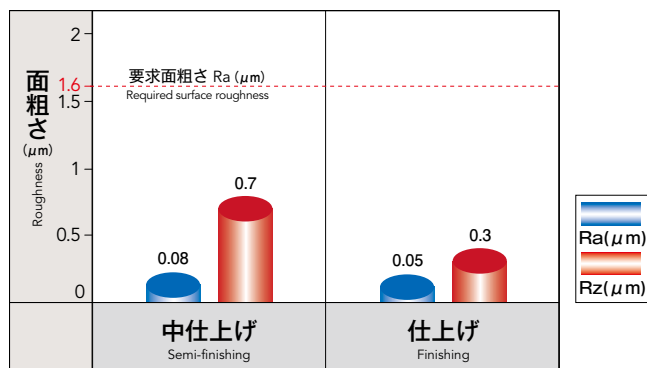

BT30の小型マシニングセンタで中仕上げ、仕上げの加工を行った。どちらも要求以下の面精度が得られた。中仕上げ、仕上げの2パスを1パスに変更可能となり、加工時間の短縮が見込める。

Semi-finishing and finishing took place with the BT30 small machining center. The PFAL cutter was able to meet the required surface roughness in both processes. Moreover, the number of passes was reduced from 2 to 1 during both semi-finishing and finishing, shortening machining time.

■切りくず形状解析 Analysis of Cutting Chip Shape

アルミボディだからこそ避きたい・・・切りくずのボディ接触

The aluminum cutter body must avoid direct contact with cutting chips

切りくず排出のイメージ Image of chip evacuation

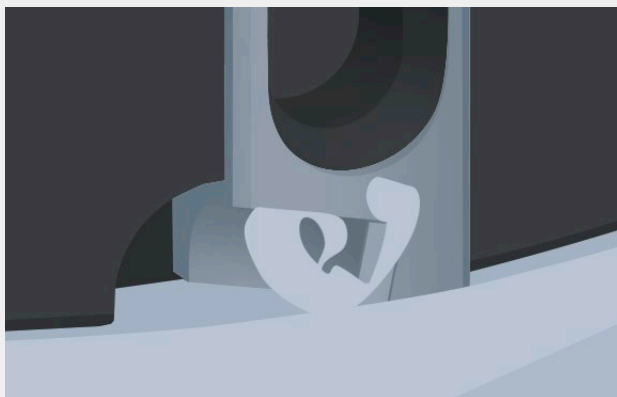

切りくずがボディに接触しません!

The cutting chip does not come in direct contact with the body!

ブレードのチップポケット内で切りくずが処理されており、アルミボディには接触していません。

Cutting chips are processed through the blade's chip pocket to prevent them from coming into contact with the aluminum cutter body.

Technical Data

■ 技術資料 Technical Data

■ 刃先高さ調整手順 Instructions for Adjusting the Cutting Edge Height

■ 各部名称

Names of Components



Ⓐ T型レンチ (T25-T)
T-Wrench



Ⓑ L型レンチ (3MM-L)
L-Wrench



① ウェッジの確認

Confirm Wedge Position

ウェッジの表面がボディ外周面と同程度の位置にあるか装着具合を確認。

Check and ensure that all wedges are in the correct position. Make adjustments when necessary.



正
Correct



誤
Incorrect

② ノーマルブレード/ワイパーブレードの取り付け

Mounting of Blades

2種類のブレードを10N・mのトルクで締め付ける(本締め)。ワイパーブレードはボディに表示されている装着マークの箇所に1枚取り付け。

Mount one wiper blade (FR1204-W) to the wiper blade position indicator and the normal blades (FR1204 or FR1206) to the remaining positions.

Using the T-Wrench (Ⓐ), tighten the clamp screw completely to 10N・m.



● ワイパーブレード装着マーク
Wiper Blade Position Indicator

※付属のT型レンチ(Ⓐ)を使用。ボディ接触面とウェッジに密着するようにブレードを指で押さえながら締め付ける。

③ 刃先高さの測定

Measurement of Cutting Edge Height

全ての刃先高さを測定し、ノーマルブレードの中で最も高い刃を確認。

Measure all of the cutting edge heights and determine the highest normal cutting edge.

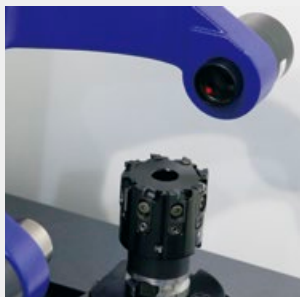

刃先高さ Cutting Edge Height

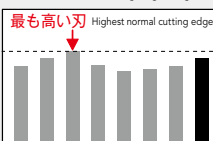

■ ノーマルブレード Normal Blade
■ ワイパーブレード Wiper Blade

④ ノーマルブレードの刃先高さ調整

Adjustment of Normal Blades

最も高い刃を基準に、その他のノーマルブレードの刃先高さを合わせるように調整(推奨0.005mm以内)。

ウェッジ用クランプねじを時計回りに回すことにより刃先が上がる。

Adjust all other normal cutting edges to match the highest normal cutting edge height. The offset should be within 0.005mm. To lift the wedges, use the L-Wrench (Ⓑ) to turn the wedge screw clockwise.



※付属のL型レンチ(Ⓑ)を使用

刃先高さ Cutting Edge Height



■ ノーマルブレード Normal Blade
■ ワイパーブレード Wiper Blade

⑤ワイパーブレードの刃先高さ調整

Adjustment of Wiper Blade

ノーマルブレードの刃先高さより0.02～0.04mm高く調整。

Use the L-Wrench (B) to adjust the wiper blade so that it is 0.02 - 0.04mm higher than the other normal blades.



※付属のL型レンチ(B)を使用

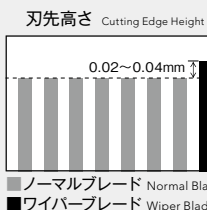

ワイパーブレードの刃先位置 Cutting Edge Position of the Wiper Blade

ワイパーブレードは、ノーマルブレードに対して0.8mm程度内側に設定されています。これにより、底刃のみの働きをすることで高い切込みでも仕上げ面方向の効果を発揮します。

The wiper blade is automatically set to be 0.8mm closer to the interior than the normal blade. Based on this design, only the bottom of the wiper edge is used during processing, thus enabling a high quality surface finish even in high depth (ap) milling.

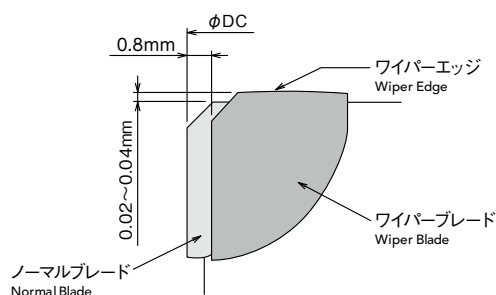

使用上の注意

Cautions during use

- ・刃先高さは上げる方向のみ調整可能です。
- ・調整可能範囲は0.6mmです。
- ・調整範囲の上限に近いところでは、刃先高さが上がりにくくなります。この場合は、一旦ブレードを取り外し、ウェッジを最初の位置に戻してから再度調整を行って下さい(①ウェッジの確認)。
- ・ダイヤル端子を刃先へ接触させたり離したりする際には、大きな衝撃を与えないように注意して下さい。
- ・Blades can be adjusted by lifting upward only.
- ・Maximum adjustment is 0.6mm.
- ・When the maximum adjustment limit is reached, remove the blade and start over from step ①.
- ・When measuring the edge height using a contact tool presetter with a touch probe, please be cautious to not damage the PCD edge.

■仮締め不要。本締めクランプ後に刃先高さの調整ができ、セッティング時間の短縮が可能。

Temporary tightening is not required. Cutting edge height can be adjusted after complete tightening of the clamping screw, making the setup process quick and effortless.

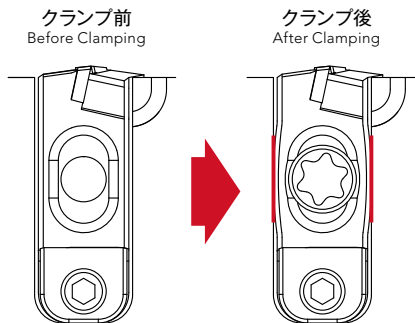

本締めクランプ時にブレードの両サイドが膨らみブレードとボディを多面拘束

The tightening of the clamping screw pushes sides of the blade outward, locking it tightly in place with the cutter body

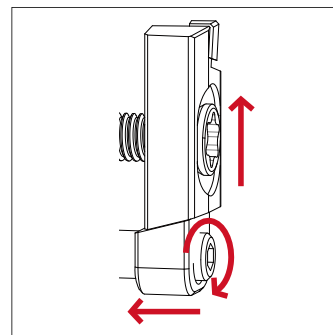

本締めクランプ後、ブレードはしっかりと拘束された状態を保ちながらウェッジのテーパ部がブレードを押し上げます。押し上げたブレードはウェッジが支えている為、加工中に動くことはありません。

After tightening the clamping screw, the blade is locked into position secured by the wedge taper. The wedge assures a fix and unmovable blade position during machining.

オーエスジーでは刃先高さを調整するプリセッタを取り扱っています

OSG offers tool presetter for cutting edge height adjustment

当社での刃先高さ調整のサービスも実施しています。(有償)
詳細は当社営業にお問い合わせ下さい。
OSG offers PFAL height adjustment services upon request.
(surcharges apply)
Contact your local sales representative for details.

OZT ツールプリセッタ OZT Tool Presetter

精度の高い工具プリセット

Precisely Set Tools

加工前に工具の測定や許容値の確認、調整が可能です。

Every tool is measured, checked for tolerances, and adjusted before being used.



迅速かつ簡単

Fast and Easy

従来の面倒な位置合わせ作業は不要です。画面上でダイナミッククロスヘア(自動刃先認識システム)が刃先を迅速かつ正確に捉えます。

No more hassle with positioning. The dynamic crosshair (automatic cutting edge detection) quickly and accurately captures the cutting edge on the display.



早い画像認識

Fast Image Recognition

最新の画像システムとソフトウェアは迅速に刃先を測定します。

The latest vision system—camera and software—measures the cutting edge in just seconds.

■ OZTツールプリセッタの詳細はこちらのカタログをご参照下さい。

Scan code to view OZT Tool Presetter product catalog.



OZT-3

より高能率・高精度な加工を求められる方へ

PFALの回転バランス調整サービスを行っております

For manufacturers seeking even greater milling efficiency and precision
PFAL rotation rebalancing services are available upon request

PFALの回転バランス調整サービス PFAL Rotation Rebalancing Services

一般的に大径カッタを高速回転で使用した場合に起こり得る問題点…

When a large diameter cutter rotates in high speed...

遠心力を受けて振動が発生しやすくなる

The direction of the centrifugal force changes steadily as it rotates with the spindle, causing vibrations

→ 工具や機械主軸の寿命が短くなる

Leads to shorter tool life and spindle life

→ 加工精度や加工面品質に悪影響が生じる

Decreases accuracy and surface finish quality

■そこで当社では、お客様が使用されるアーバに PFALを取り付けた状態でバランス調整を行う サービスを実施しています。(有償)

OSG offers rotation rebalancing services to customers with the PFAL cutter body mounted to the arbor. (surcharges apply)

バランス調整にはウェイトねじを使用するため、
カッタ自体のバランス精度を損なう心配はありません。

The balancing accuracy of the cutter body itself will not be changed
since the balancing is performed using socket set screws as balancing weight.

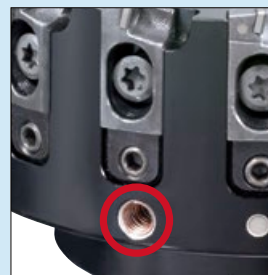

使用する回転バランス測定器 Balancing Machine

HAIMER
ツール・ダイナミックTD2009コンフォートプラス
Tool Dynamic TD 2009 Comfort Plus

特長 Features

- 工具単体、ホルダ&工具、ホルダ単体のバランス測定が可能
For balancing of individual cutting tool, individual tool holder, or a combination of both holder and tool
- 誰でも簡単に操作可能
Easy operation
- 短時間で測定
Quick and efficient
- 具体的なバランス調整方法を提示
User-friendly guidance

当該サービス対象の主軸タイプ Applicable Spindle Type

BT30, BT40, BT50, HSK-50, HSK-63



» Phoenix PFB

仕上げ用ボールエンドミル
Finishing Ball End Mill

Phoenix Finishing Ball

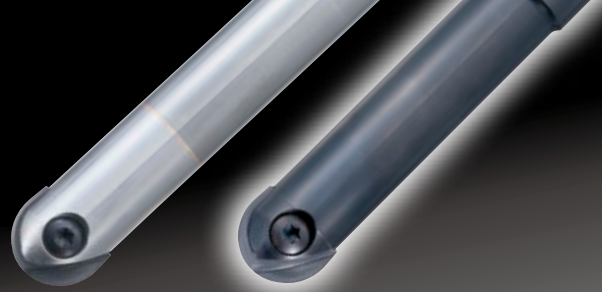

インデキサブルタイプの仕上げ用ボールエンドミル。
高いボディ取り付け精度が、良好な加工面、長寿命を可能にします。

The high precision mounting of the insert into the body enables a superior milling surface and long tool life.



■インサートの特長

Features of Insert

・高いボールR精度 ±6μm
High radius precision
※PFB-Dのみ±10μm
PFB-D only

・切れ味の良いスパイラル刃形
Spiral cutting edge with excellent sharpness

PFB-SP

- 軟鋼から耐熱合金まで幅広い被削材をカバー
- 切れ味と刃先剛性を兼備
- 優れた耐欠損性
- Applicable to a wide variety of work materials from mild steel to HRSA
- Sharp but rigid cutting edge
- Excellent chipping resistance

XP3320材種 Grade

- ・ 鋼・ステンレス鋼・鋳鉄の乾式加工向け
- ・ 耐熱合金(湿式)に対応
- ・ For dry milling of steel, stainless steel, and cast iron
- ・ For wet milling of HRSA

PFB-Q

- 有効切れ刃範囲220°でアンダーカットに対応
- 最外周部にストレート部分が無く、びびりやすい立壁加工に対応
- Applicable to undercuts with 220° effective cutting edge section
- No straight cutting edge at the outer peripheral surface, which is applicable to standing wall milling that occurs chattering

XP3225材種 Grade

- ・ 幅広い被削材の安定加工向け
- ・ 優れた潤滑性、耐摩耗性
- ・ 鋼・ステンレス鋼の湿式加工向け
- ・ For stable milling of a wide variety of work materials
- ・ Excellent lubricity and wear resistance
- ・ For wet milling of steel and stainless steel

PFB-Q-ST

- 有効切れ刃範囲200°~220°でアンダーカットに対応
- 高剛性刃形により、優れた耐欠損性
- Applicable to undercuts with 200°-220° effective cutting edge section
- Excellent wear resistance with its high rigidity cutting geometry

XP2225材種 Grade

- ・ ステンレス鋼・耐熱合金向け
- ・ 優れた耐熱性
- ・ For stainless steel and HRSA
- ・ Excellent heat resistance

PFB-SH

- 鋳鉄・ダクタイル鋳鉄、高硬度鋼に最適な高剛性刃形
- 刃先の特殊処理により強度を向上
- 耐摩耗性の高い超硬母材を採用
- For milling cast iron, ductile iron and HRSA
- Strong cutting edge by the special processing
- Highly resistant carbide material

XP3310材種 Grade

- ・ 高硬度鋼・鋳鉄の乾式加工に最適
- ・ 優れた耐熱性、耐摩耗性
- ・ Ideal for dry milling of high hardened steel and cast iron
- ・ Excellent heat and wear resistance

NEW

PFB-HH

- 専用母材とDUROREYコーティングの組み合わせにより高硬度鋼に特化した仕様
- 特殊な刃先処理により、耐欠損性向上、加工面精度の向上
- Specifications specialized for high-hardness steels by combining a special base material and the DURORAY coating
- Special cutting edge treatment improves chipping resistance and machined surface accuracy

XP6703材種 Grade

- ・ 高硬度鋼・鋳鉄向け
- ・ 優れた耐摩耗性
- ・ For high-hardness steels and cast iron
- ・ Excellent wear resistance

PFB-D

- グラファイト加工に最適な切れ味重視の専用刃形
- 密着性に優れたダイヤモンドコーティング専用超硬母材を採用
- Sharp cutting edge specialized for milling graphite
- Highly adhesive carbide material for diamond coating

XC4505材種 Grade

- ・ 非鉄金属加工向け
- ・ グラファイト加工に最適なダイヤモンドコーティング
- ・ For milling nonferrous material
- ・ Optimal diamond coating for milling graphite

Phoenix

仕上げ用ボールエンドミル

Finishing Ball End Mill

PFB

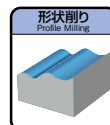

Specification

■形状寸法表 Specification

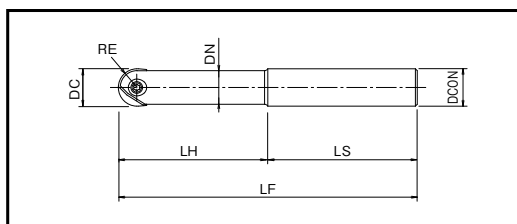

単位:mm Unit:mm

鋼シャンク Steel Shank

②	ツールNo. EDP No.	呼び Designation	外径 DC	ボール 半径 RE	全長 LF	有効長		刃数 ZEFP	シャンク径 DCON	シャンク長 LS	首径 DN	標準価格 (Yen)
						首下長 LH	L/D					
	7801400	PFB-R080SS08-S120	8	4	120	36	4.5	2	8	84	7	25,600
	7801401	PFB-R100SS10-S130	10	5	130	45	4.5	2	10	85	9	25,700
	7801402	PFB-R120SS12-S130	12	6	130	54	4.5	2	12	76	11	27,800
	7801403	PFB-R160SS16-S140	16	8	140	64	4	2	16	76	14	28,100
	7801404	PFB-R200SS20-S160	20	10	160	80	4	2	20	80	18	28,300
	7801405	PFB-R250SS25-S160	25	12.5	160	75	3	2	25	85	22	32,700
	7801406	PFB-R300SS32-S170	30	15	170	90	3	2	32	80	27	57,500
	7801407	PFB-R320SS32-S180	32	16	180	96	3	2	32	84	29	63,100

超硬シャンク ショートタイプ Carbide Shank, Short Type

単位:mm Unit:mm

①	ツールNo. EDP No.	呼び Designation	外径 DC	ボール 半径 RE	全長 LF	有効長		刃数 ZEFP	シャンク径 DCON	シャンク長 LS	首径 DN	標準価格 (Yen)
						首下長 LH	L/D					
	7801429	PFB-R060SS06-S80CS	6	3	80	15	2.5	2	6	65	5.4	37,500
	7801430	PFB-R080SS08-S100CS	8	4	100	20	2.5	2	8	80	7	39,300
	7801431	PFB-R100SS10-S100CS	10	5	100	25	2.5	2	10	75	9	40,100
	7801432	PFB-R120SS12-S110CS	12	6	110	30	2.5	2	12	80	11	47,000
	7801433	PFB-R160SS16-S140CS	16	8	140	40	2.5	2	16	100	14	56,100
	7801434	PFB-R200SS20-S160CS	20	10	160	50	2.5	2	20	110	18	79,800
	7801435	PFB-R250SS25-S160CS	25	12.5	160	62.5	2.5	2	25	97.5	22	104,000
	7801436	PFB-R300SS32-S170CS	30	15	170	75	2.5	2	32	95	27	132,000
	7801437	PFB-R320SS32-S180CS	32	16	180	80	2.5	2	32	100	29	139,000

NEXT ▶

在庫区分は全てC(標準在庫品)となります。 Stock are categorized as C (Standard stock item).

Drilling 穴加工
 Milling フライス加工
 P XD
 PD
 PHP
 PDZ
 PZAG
 PLDS
 PZAG
 PAS
 PAO
 PSF
 PSFL
 PSE
 PSEL
 PSTW
 PMD
 PHC
 PRC
 PDR
 PFAL
PFB
 PFR
 SF
 PXM
 PXM
 Technical data 技術資料
 Index 索引

Phoenix

仕上げ用ボールエンドミル

Finishing Ball End Mill

PFB

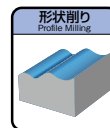

Specification

■形状寸法表 Specification

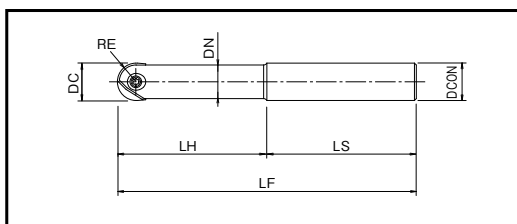

単位:mm Unit:mm

◀ FROM

超硬シャンク ロングタイプ Carbide Shank, Long Type

①	ツールNo. EDP No.	呼び Designation	外径 DC	ボール 半径 RE	全長 LF	有効長		刃数 ZEFP	シャンク径 DCON	シャンク長 LS	首径 DN	標準価格 (Yen)
						首下長 LH	L/D					
①	7801439	PFB-R060SS06-L100CS	6	3	100	30	5	2	6	70	5.4	40,900
②	7801440	PFB-R080SS08-L120CS	8	4	120	40	5	2	8	80	7	42,700
③	7801441	PFB-R100SS10-L130CS	10	5	130	50	5	2	10	80	9	43,300
④	7801442	PFB-R120SS12-L140CS	12	6	140	60	5	2	12	80	11	50,600
⑤	7801443	PFB-R160SS16-L160CS	16	8	160	72	4.5	2	16	88	14	60,200
⑥	7801444	PFB-R200SS20-L180CS	20	10	180	90	4.5	2	20	90	18	88,800
⑦	7801445	PFB-R250SS25-L200CS	25	12.5	200	100	4	2	25	100	22	116,000
⑧	7801446	PFB-R300SS32-L220CS	30	15	220	120	4	2	32	100	27	156,000
⑨	7801447	PFB-R320SS32-L230CS	32	16	230	128	4	2	32	102	29	165,000

超硬シャンク エキストラロングタイプ Carbide Shank, Extra Long Type

単位:mm Unit:mm

①	ツールNo. EDP No.	呼び Designation	外径 DC	ボール 半径 RE	全長 LF	有効長		刃数 ZEFP	シャンク径 DCON	シャンク長 LS	首径 DN	標準価格 (Yen)
						首下長 LH	L/D					
①	7801419	PFB-R060SS06-LL120CS	6	3	120	42	7	2	6	78	5.4	43,100
②	7801420	PFB-R080SS08-LL140CS	8	4	140	56	7	2	8	84	7	45,000
③	7801421	PFB-R100SS10-LL150CS	10	5	150	70	7	2	10	80	9	45,500
④	7801422	PFB-R120SS12-LL160CS	12	6	160	84	7	2	12	76	11	57,300
⑤	7801423	PFB-R160SS16-LL200CS	16	8	200	96	6	2	16	104	14	63,200
⑥	7801424	PFB-R200SS20-LL240CS	20	10	240	120	6	2	20	120	18	95,500
⑦	7801425	PFB-R250SS25-LL260CS	25	12.5	260	137.5	5.5	2	25	122.5	22	136,000
⑧	7801426	PFB-R300SS32-LL290CS	30	15	290	165	5.5	2	32	125	27	193,000
⑨	7801427	PFB-R320SS32-LL300CS	32	16	300	176	5.5	2	32	124	29	204,000

▶ NEXT

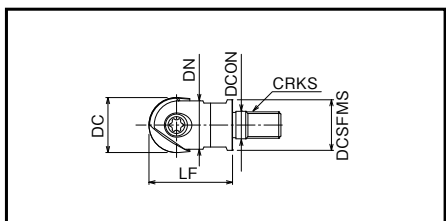

FROM

ねじ込みタイプ Screw Fit Type

単位:mm Unit:mm

③	ソールNo. EDP No.	呼び Designation	外径 DC	刃数 ZEPF	取付け径 DCON	ねじサイズ CRKS	スパナサイズ Spanner Size	全長 LF	首径 DN	端面径 DCSFMS	適用シャンク ホルダタイプ Applicable Shank	標準価格 (Yen)
③	7801490	PFB-R100SF6	10	2	6.5	M 6	7	26	9	9	①	18,800
④	7801491	PFB-R120SF6	12	2	6.5	M 6	7	26	11	11	②	19,300
⑤	7801492	PFB-R160SF8	16	2	8.5	M 8	10	32	14	14.5	③	22,400
⑥	7801493	PFB-R200SF10	20	2	10.5	M10	14	38	18	18	④	25,200
⑦	7801494	PFB-R250SF12	25	2	12.5	M12	17	38	22	23	⑤	29,900
⑧	7801495	PFB-R300SF16	30	2	17	M16	22	43	27	28	⑥	39,000

シャンクホルダについてはp.242 ~ p.244をご覧ください。
See p.242-p.244 for shank holders.

Accessories

■ 部品 Accessories

	ソールNo. EDP No.	呼び Designation	適用ボディタイプ Applicable Body	推奨締め付けトルク Recommended Tightening Torque
 クランプねじ Clamping Screw	7808124	FS20652RB	①	0.4N・m
	7808123	FS25669RB	②	1N・m
	7808117	FS30686RB	③	1.2N・m
	7808118	FS35610RB	④	2N・m
	7808119	FS40613RB	⑤	3N・m
	7808120	FS50615RB	⑥	5N・m
	7808121	FS60620RB	⑦	5N・m
	7808122	FS80624RB	⑧, ⑨	6N・m

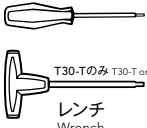
	ソールNo. EDP No.	呼び Designation	適用ボディタイプ Applicable Body	標準価格 (Yen)
 T30-Tのみ T30-T only レンチ Wrench	7808203	T6-D (Torx6)	①	1,050
	7808204	T7-D (Torx7)	②	1,050
	7808205	T8-D (Torx8)	③	1,190
	7808207	T10-D (Torx10)	④	1,190
	7808208	T15-D (Torx15)	⑤	1,260
	7808209	T20-D (Torx20)	⑥, ⑦	1,260
	7808212	T30-T (Torx30)	⑧, ⑨	2,520

レンチは別途ご購入下さい。 The wrenches are sold separately from the cutters.

Phoenix

仕上げ用ボールエンドミル
Finishing Ball End Mill

PFBインサート

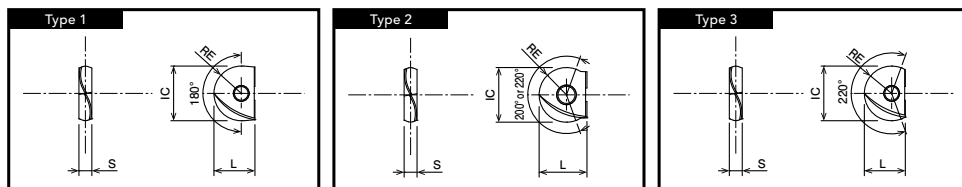

Inserts

Inserts



■適用インサート Inserts



単位:mm Unit:mm

形状 Appearance	呼び Designation	切れ 刃数 No. of Cutting Edges	有効 R角度 Range Deg°	インサート寸法 Insert Size				形状 タイプ Type	適用 ボディ タイプ Applicable Body	コーティング材種 Grade of Coated Materials						標準価格 (Yen)
				内接 円径 IC	ボール 半径 RE	厚さ S	L			XP3225	XP3310	XP3320	XP2225	XP6703	XC4505	
 スパイラルタイプ Spiral Type	PFB080-SP	2	180	8	4	2.4	7	1	②	7820030		7820010				5,380
	PFB100-SP			10	5	2.6	8.5		③	7820031		7820011				5,640
	PFB120-SP			12	6	3	10		④	7820032		7820012				6,020
	PFB160-SP			16	8	4	12		⑤	7820033		7820013				6,250
	PFB200-SP			20	10	5	15		⑥	7820034		7820014				6,500
	PFB250-SP			25	12.5	6	18.5		⑦	7820035		7820015				7,390
	PFB300-SP			30	15	7	22.5		⑧	7820036		7820016				9,370
 スパイラルタイプ (球形状) Spiral Type (Full Radius Type)	PFB060-Q	2	220	6	3	2	5	2	①	7820048						4,820
	PFB070-Q			7	3.5	2	5.5		①	7820049						4,970
	PFB080-Q			8	4	2.4	7		②	7820050						5,380
	PFB100-Q			10	5	2.6	8.5		③	7820051						5,640
	PFB120-Q			12	6	3	10	④	7820052						6,020	
	PFB160-Q			16	8	4	12	3	⑤	7820053						6,250
	PFB200-Q			20	10	5	15		⑥	7820054						6,500
	PFB250-Q			25	12.5	6	18.5		⑦	7820055						7,390
PFB300-Q	30	15	7	22.5	⑧	7820056							9,370			
 ストレートタイプ (球形状) Straight Type (Full Radius Type)	PFB080-Q-ST	2	200	8	4	2.4	7	2	②				7820060			5,380
	PFB100-Q-ST			10	5	2.6	8.5		③				7820061			5,620
	PFB120-Q-ST			12	6	3	10		④				7820062			6,020
	PFB160-Q-ST			16	8	4	12		⑤				7820063			6,250
	PFB200-Q-ST		20	10	5	15	3	⑥				7820064			6,480	
	PFB250-Q-ST		25	12.5	6	18.5		⑦				7820065			7,390	
	PFB300-Q-ST		30	15	7	22.5		⑧				7820066			9,370	

NEXT

FROM

単位:mm Unit:mm

形状 Appearance	呼び Designation	切れ 刃数 No. of Cutting Edges	有効 R角度 Range Deg'	インサート寸法 Insert Size				形状 タイプ Type	適用 ボディ タイプ Applicable Body	コーティング材種 Grade of Coated Materials						標準価格 (Yen)	
				内接 円径 IC	ボール 半径 RE	厚さ S	L			XP3225	XP3310	XP3320	XP2225	XP6703	XC4505		
 スパイラルタイプ (刃先強化) Spiral Type (Reinforced Edge Type)	PFB060-SH	2	220	6	3	2	5	2	①		7820039					4,820	
	PFB080-SH		180		8	4	2.4	7	1	②		7820040					5,380
	PFB100-SH				10	5	2.6	8.5		③		7820041					5,640
	PFB120-SH				12	6	3	10		④		7820042					6,020
	PFB160-SH				16	8	4	12		⑤		7820043					6,250
	PFB200-SH				20	10	5	15		⑥		7820044					6,500
	PFB250-SH				25	12.5	6	18.5		⑦		7820045					7,390
	PFB300-SH				30	15	7	22.5		⑧		7820046					9,370
	PFB320-SH				32	16	7	23.5		⑨		7820047					10,600
 スパイラルタイプ (刃先強化) Spiral Type (Reinforced Edge Type)	PFB100-HH	2		180	10	5	2.6	8.5		1	③				NEW 7820107		5,640
	PFB120-HH		12		6	3	10	④				NEW 7820108		6,020			
	PFB160-HH		16		8	4	12	⑤				NEW 7820109		6,250			
	PFB200-HH		20		10	5	15	⑥				NEW 7820110		6,500			
	PFB250-HH		25		12.5	6	18.5	⑦				NEW 7820111		7,390			
	PFB300-HH		30		15	7	22.5	⑧				NEW 7820112		9,370			
	PFB320-HH		32		16	7	23.5	⑨				NEW 7820113		10,600			
 スパイラルタイプ (ダイヤモンド コーティング) Spiral Type (Diamond Coated)	PFB060-D	2	220	6	3	2	5	2	①						7820018	14,500	
	PFB070-D			7	3.5	2	5.5		①						7820019	14,900	
	PFB080-D		180		8	4	2.4	7	1	②						7820020	16,200
	PFB100-D				10	5	2.6	8.5		③						7820021	17,000
	PFB120-D				12	6	3	10		④						7820022	18,100
	PFB160-D				16	8	4	12		⑤						7820023	18,800
	PFB200-D				20	10	5	15		⑥						7820024	19,500
	PFB250-D				25	12.5	6	18.5		⑦						7820025	22,200
	PFB300-D				30	15	7	22.5		⑧						7820026	28,300

Phoenix

仕上げ用ボールエンドミル
Finishing Ball End Mill

PFB

Cutting Conditions

■切込深さと実加工径 (φ De) 早見表 Chart of cutting depth and actual cutting diameter

単位:mm Unit:mm

ap(切込深さ) Depth of cut		実加工径 (φ De) Actual cutting diameter														
外径 DC	ボール半径 RE	0.1	0.2	0.3	0.4	0.5	0.8	1	1.5	2	2.5	3	3.5	4	4.5	5
6	3	1.5	2.2	2.6	3	3.3	4.1									
7	3.5	1.6	2.3	2.8	3.3	3.6	4.5									
8	4	1.8	2.5	3	3.5	3.9	4.8									
10	5	2	2.8	3.4	3.9	4.4	5.4	6	7.1							
12	6	2.2	3.1	3.7	4.3	4.8	6	6.6	7.9	8.9						
16	8	2.5	3.6	4.3	5	5.6	7	7.7	9.3	10.6	11.6					
20	10	2.8	4	4.9	5.6	6.2	7.8	8.7	10.5	12	13.2	14.3	15.2			
25	12.5	3.2	4.5	5.4	6.3	7	8.8	9.8	11.9	13.6	15	16.2	17.3	18.3		
30	15	3.5	4.9	6	6.9	7.7	9.7	10.8	13.1	15	16.6	18	19.3	20.4	21.4	22.4
32	16	3.6	5	6.2	7.1	7.9	10	11.1	13.5	15.5	17.2	18.7	20	21.2	22.2	23.2

●実加工径 (φ De) の求め方 How to determine actual cutting diameter

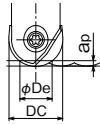

$$De = 2\sqrt{ap \times (DC - ap)}$$

■推奨ピックフィードと加工面粗さ Recommended pick feed and milling surface roughness

単位:mm Unit:mm

外径 DC	6	7	8	10	12	16	20	25	30	32
ピックフィード Pf	0.4	0.45	0.5	0.6	0.7	0.8	1	1.2	1.3	1.4
加工面粗さ h	0.007	0.007	0.008	0.009	0.01	0.01	0.012	0.014	0.014	0.015

■理論上の加工面粗さ Theoretical milling surface roughness

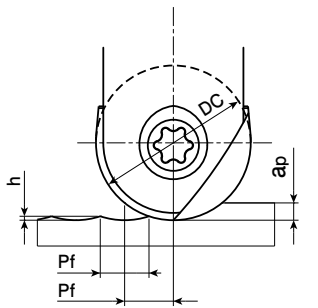

例) DC=20mm
Pf=1mm
→ h=0.0125mm

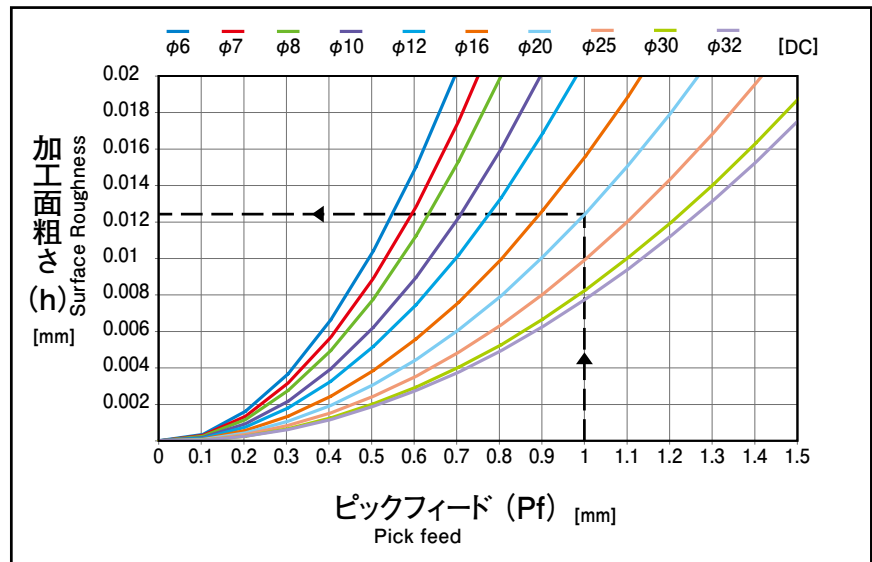

■被削材別推奨材質

Recommended Materials by Insert Type

◎第一推奨材質 Best
○第二推奨材質 Good

インサート材種 Insert Grades	形状 Appearance	P	M	K	N	S	H
XP3320	PFB-SP	○	○	○		○	○
XP3225	PFB-Q	◎	○		◎*1	○	
XP3310	PFB-SH			◎			◎
XP2225	PFB-Q-ST	○	◎			◎	○
XP6703	PFB-HH	○		○			◎
XC4505	PFB-D				◎*2		

*1 アルミニウム合金、銅合金の第一推奨 Best recommended for aluminum and copper alloy applications
*2 グラファイト、CFRPの第一推奨 Best recommended for graphite and CFRP applications

■切削条件基準表 Cutting Conditions

PFB-SP・PFB-Q・PFB-SH・PFB-Q-ST・PFB-HH

	被削材 Work Material	引張強さ・硬さ Tensile Strength・Hardness	切削速度 Vc(m/min) Cutting Speed	切込深さの 目安 ap (mm) Depth of Cut	1刃当たりの送り fz (mm/t)			
					カット径DC			
					φ6, 8	φ10, 12	φ16, 20	φ25~32
P	軟鋼、低炭素鋼 Mild Steel, Carbon Steel (SS400, S10C)	~180HB	300 (200~400)	0.02DC	0.1	0.12	0.14	0.18
	炭素鋼、合金鋼 Carbon Steel, Alloy Steel (S50C, SCM440)	~280HB	300 (200~400)	0.02DC	0.07	0.1	0.12	0.14
	ダイス鋼 Die Steel (SKD61, SKD11)	~280HB	250 (150~350)	0.02DC	0.07	0.1	0.12	0.14
M	ステンレス鋼 Stainless Steel (SUS304, SUS420)	~250HB	250 (150~350)	0.02DC	0.07	0.12	0.14	0.17
K	鋳鉄 Cast Iron (FC250)	~300N/mm ²	400 (300~500)	0.02DC	0.12	0.14	0.18	0.22
	ダクタイル鋳鉄 Ductile Cast Iron (FCD400)	~600N/mm ²	300 (200~400)	0.02DC	0.1	0.12	0.14	0.18
N	アルミニウム合金 Aluminum Alloy	~13%Si	500 (400~600)	0.03DC	0.12	0.14	0.18	0.22
	銅合金 Copper Alloy (C1100)	-	300 (200~400)	0.03DC	0.11	0.13	0.17	0.2
S	超耐熱合金(湿式) Superalloy (Wet) (Inconel 718)	-	50 (25~80)	0.015DC	0.04	0.05	0.06	0.06
	チタン合金(湿式) Titanium Alloy (Wet) (Ti-6Al-4V)	-	90 (40~120)	0.02DC	0.06	0.08	0.11	0.13
H	プリハードン鋼 Pre-hardened Steel (NAK80, STAVAX)	40~43HRC	200 (100~300)	0.015DC	0.06	0.07	0.08	0.1
	ダイカスト鋼 Die Cast Steel (DAC-MAGIC, DH31)	43~48HRC	180 (90~200)	0.015DC	0.05	0.06	0.07	0.07
	調質鋼 Hardened Steel (SKD11)	50~60HRC	150 (100~250)	0.01DC	0.05	0.06	0.07	0.07

・上記の数値は実切削速度における一般的な値を示したものです。加工環境に合わせて適宜調整して下さい。
The above cutting conditions are to be used as general guidelines. Adjustments may be necessary depending on actual cutting conditions.

PFB-D

	被削材 Work Material	引張強さ・硬さ Tensile Strength・Hardness	切削速度 Vc(m/min) Cutting Speed	切込深さの 目安 ap (mm) Depth of Cut	1刃当たりの送り fz (mm/t)			
					カット径DC			
					φ6, 8	φ10, 12	φ16, 20	φ25~32
N	グラファイト Graphite	-	500 (400~600)	0.03DC	0.14	0.17	0.21	0.25
	複合材 Carbon Fiber Reinforced Plastic (CFRP)	-	400 (300~500)	0.03DC	0.11	0.13	0.17	0.2

・上記の数値は実切削速度における一般的な値を示したものです。加工環境に合わせて適宜調整して下さい。
The above cutting conditions are to be used as general guidelines. Adjustments may be necessary depending on actual cutting conditions.

Cutting Data

■加工データ Cutting Data

■XP2225によるタービンブレードの翼面仕上げ加工 Finishing of turbine blade with the XP2225

使用工具 Tool	PFB-R160SF8	他社品 Competitor
使用インサート(材種) Insert (grade)	PFB160-Q-ST (XP2225)	超硬コーティングインサート Coated Carbide Insert
部品名 Work	タービンブレード(切削長487m/1枚当り) Turbine Blade (Cutting length 487 m / per blade)	
被削材 Work Material	SUS430	
切削速度 Cutting Speed	420m/min (8,350min ⁻¹)	
送り速度 Feed	6,687mm/min (0.4mm/t)	
切込深さ Depth of Cut	ap=0.2mm Pf=0.5mm	
切削油剤 Coolant	水溶性切削油剤 Water-Soluble	
使用機械 Machine	ブレード専用5軸機 5-axis machine exclusive for blade machining	

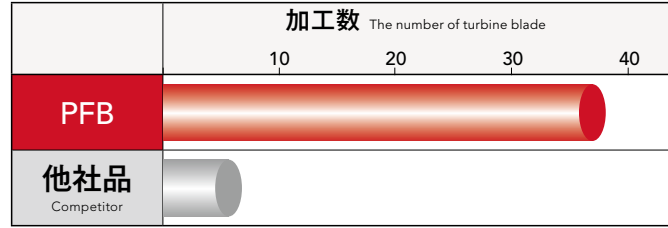

新設計の刃型により高速加工と欠け対策を実現した。新材種により、耐久も大幅UPとなった。
Achieved high-speed milling without chipping by the newly designed cutting geometry. Durability has also greatly increased due to the new material grade.

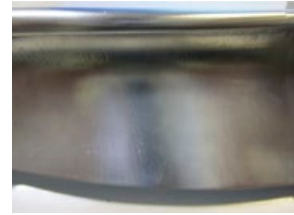

■FCD700相当材の大型プレス金型仕上げ加工 Finishing milling on large press die of FCD700

使用工具 Tool	PFB-R300SS32-LL290CS (R15 x 2刃)
使用インサート(材種) Insert (grade)	PFB300-SH (XP3310)
部品名 Work	サイドパネルアウター Side panel outer
被削材 Work Material	GGG70L (FCD700相当) Equivalent
切削速度 Cutting Speed	565m/min (6,000min ⁻¹)
送り速度 Feed	5,600mm/min (0.47mm/t)
加工方法 Cutting Method	微い加工 Profiling Milling
切込深さ Depth of Cut	ap=0.17mm Pf=0.5mm
切削油剤 Coolant	なし(エアブロー) Air Blow
使用機械 Machine	門形マシニングセンタ(BT50) Double Column Machining Center



51時間加工後の刃先にカケは無く良好な摩耗状態であった。ワークを測定するとすべての箇所ですべての箇所要求される形状精度を満たしており、光沢のある良好な加工面が得られた。
Reasonable wear and no chipping of cutting edge occurred after 51 hours of machining. All points of the work material met the required form accuracy, and the shiny machined surface was achieved.

■ダイヤモンドコーティングの驚異的な耐久性能 Surprising durability of the diamond coating

使用工具 Tool	PFB-R250SS25-S160 (R12.5 x 2刃)	
使用インサート(材種) Insert (grade)	PFB250-SP (XP3320)	PFB250-D (XC4505)
被削材 Work Material	グラファイト Graphite	
切削速度 Cutting Speed	220m/min (2,800min ⁻¹)	
送り速度 Feed	560mm/min (0.1mm/t)	
加工方法 Cutting Method	平面ピック加工 Pick Milling	
切込深さ Depth of Cut	ap=12.5mm Pf=0.2mm	
切削油剤 Coolant	なし None	
使用機械 Machine	立形マシニングセンタ(BT40) Vertical Machining Center	

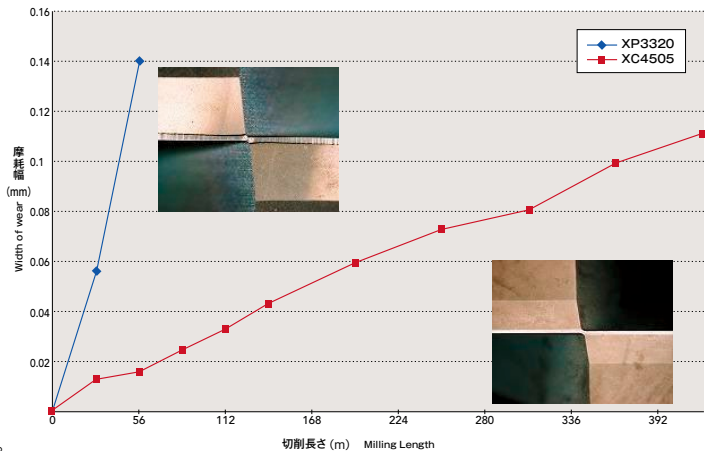

グラファイト加工においてダイヤモンドコーティングの優位性が確認できた。
Diamond coating showed its superiority in machining graphite.

SUH600のブレード加工 (摩耗量比較) Milling of a SUH600 blade (Comparison of tool wear)

使用工具 Tool	PFB-R200SS20-S160 (R10×2刃)
使用インサート(材種) Insert (grade)	PFB200-SP (XP3320)
部品名 Work	ブレード サンプルモデル Blade Sample Model
被削材 Work Material	SUH600相当品 Equivalent
工具突出し量 Overhang Length	110mm
切削速度 Cutting Speed	94m/min (1,500min ⁻¹)
送り速度 Feed	2,000mm/min (0.67mm/t)
加工方法 Cutting Method	倣い加工 Profiling Milling
切込深さ Depth of Cut	ap=0.2mm Pf=1mm
切削油剤 Coolant	水溶性切削油剤 Water-Soluble
使用機械 Machine	立形マシニングセンタ(BT40) Vertical Machining Center

ワーク上面 R300
Workpiece top surface

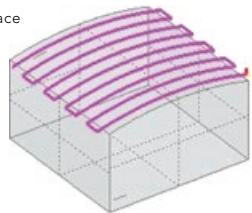

加工時間 Time	70分 minutes		140分 minutes	
切削長さ Milling Length	100m		200m	
PFB				
	摩耗量 (mm) Wear amount	0.033	0.030	0.041
他社品 Competitor				
	摩耗量 (mm) Wear amount	0.032	0.033	0.070

200m加工終了時点でPFBは他社品の1/2の摩耗量であった。
In comparison to competitor products, the PFB has half the amount of tooling wear after machining 200m.

S50Cの30°傾斜面加工 S50C at 30°inclined surface machining

使用工具 Tool	PFB-R200SS20-S160 (R10×2刃)
使用インサート(材種) Insert (grade)	PFB200-SP (XP3225)
被削材 Work Material	S50C
工具突出し量 Overhang Length	80mm
切削速度 Cutting Speed	300m/min (4,800min ⁻¹)
送り速度 Feed	1,344mm/min (0.14mm/t)
加工方法 Cutting Method	直線ピック 傾斜30° Straight line pick 30-degree inclination
切込深さ Depth of Cut	ap=0.1mm Pf=0.5mm
切削油剤 Coolant	なし(エアブロー) Air Blow
使用機械 Machine	横形マシニングセンタ(BT40) Horizontal Machining Center

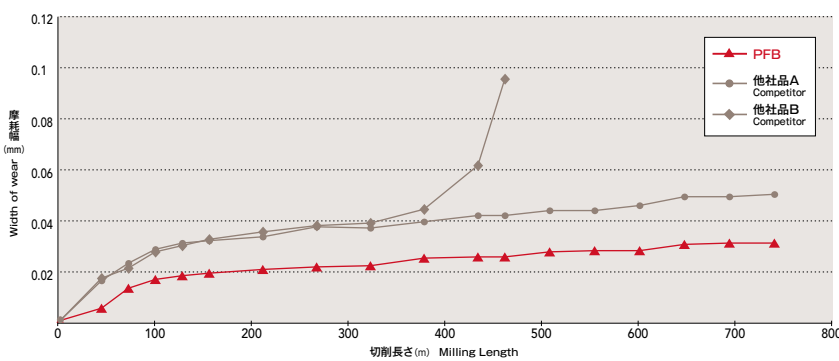

XP3225は初期段階から他社品よりも摩耗幅が小さく、突発的な欠けも無く安定した加工が可能であった。
The XP3225 is capable of achieving stable machining without abrupt interruptions and tool chipping. In comparison to competitor products, tooling wear on the XP3225 in the initial machining stage was minimal.

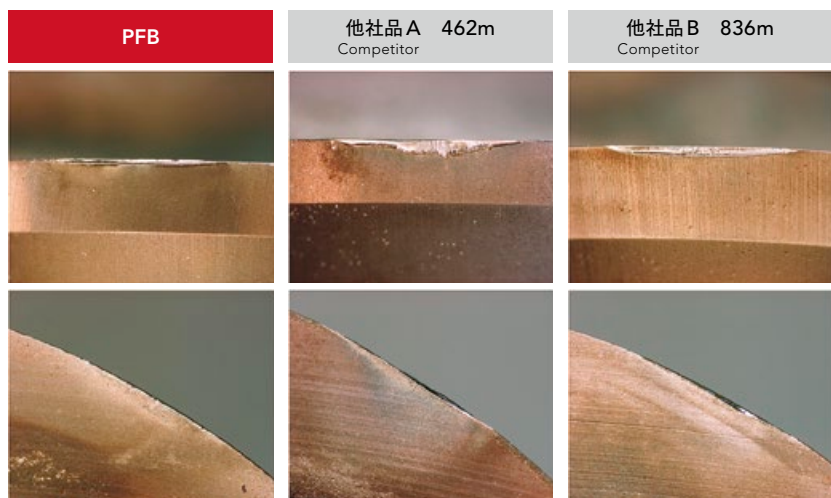

Cutting Data

加工データ Cutting Data

FC250の金型入れ子加工 Machining die insert with FC250

使用工具 Tool	PFB-R200SS20-LL240CS (R10×2刃)
使用インサート(材種) Insert (grade)	PFB200-SH (XP3310)
部品名 Work	金型入れ子 Die Insert
被削材 Work Material	FC250
工具突出し量 Overhang Length	160mm
切削速度 Cutting Speed	345m/min (5,500min ⁻¹)
送り速度 Feed	4,000mm/min (0.36mm/t)
加工方法 Cutting Method	倣い加工、等高線加工 Profile Milling, Contour Milling
切込深さ Depth of Cut	ap=0.2mm Pf=0.25mm
切削油剤 Coolant	なし(エアブロー) Air Blow
使用機械 Machine	立形マシニングセンタ(BT50) Vertical Machining Center



他社品と比較して光沢面および加工ワーク精度が向上した。
The finished surface and accuracy increased compared by the competition.

PFB-Dによるグラファイト電極加工 Machining graphite electrode with PFB-D

使用工具 Tool	PFB-R160SS16-LL200CS (R8×2刃)	PFB-R080SS08-LL140CS (R4×2刃)
使用インサート(材種) Insert (grade)	PFB160-D (XC4505)	PFB080-D (XC4505)
被削材 Work Material	グラファイト電極 Graphite electrode	
工具突出し量 Overhang Length	120mm (7.5D)	110mm (13.75D)
切削速度 Cutting Speed	400m/min (8,000min ⁻¹)	100m/min (4,000min ⁻¹)
送り速度 Feed	8,000mm/min (0.5mm/t)	2,160mm/min (0.27mm/t)
加工方法 Cutting Method	倣い加工、等高線加工 Profile and Contour Milling	
切込深さ Depth of Cut	ap=8mm Pf=12mm	ap=0.3mm Pf=0.24mm
切削油剤 Coolant	なし None	
使用機械 Machine	立形マシニングセンタ(BT40) Vertical Machining Center	



 YouTube



SKD11の金型入れ子加工 Die insert with SKD11

使用工具 Tool	PFB-R100SS10-LL150CS (R5×2刃)
使用インサート(材種) Insert (grade)	PFB100-SP (XP3320)
部品名 Work	金型入れ子 Die Insert
被削材 Work Material	SKD11相当品 (58HRC) Equivalent
工具突出し量 Overhang Length	80mm
切削速度 Cutting Speed	200m/min (8,000min ⁻¹)
送り速度 Feed	2,000mm/min (0.125mm/t)
加工方法 Cutting Method	倣い加工、等高線加工 Profile Milling, Contour Milling
切込深さ Depth of Cut	ap=0.1mm Pf=0.2mm
切削油剤 Coolant	なし(エアブロー) Air Blow
使用機械 Machine	立形マシニングセンタ(HSK40) Vertical Machining Center

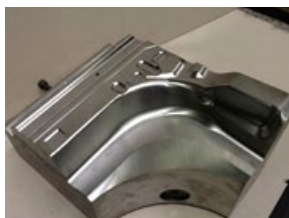

7時間加工後の刃先の状態

Cutting edge after 7 hours of milling

加工終了後の刃先に異常な損傷は見られず良好な損傷形態であった。
加工面も他社品より均一で良好だった。
Cutting edge had normal wear without abnormal damage after finishing 7 hours of machining. Finished surface was much smoother and consistant versus competiton.

SKD61(52HRC)の長寿命加工 Long tool life in SKD61 (52 HRC)

使用工具 Tool	PFB-R200SS20-L180CS (R10×2刃)
使用インサート(材種) Insert (grade)	PFB200-HH(XP6703)
被削材 Work Material	SKD61(52HRC)
加工方法 Cutting Method	形状加工 Profile Milling
切削速度 Cutting Speed	250m/min (3,980min ⁻¹)
送り速度 Feed	1,592mm/min (0.2mm/t)
切込深さ Depth of Cut	a _p =0.2mm Pf=0.3mm
切削油剤 Coolant	なし(エアブロー) Air Blow
使用機械 Machine	横形マシニングセンタ(BT50) Horizontal Machining Center

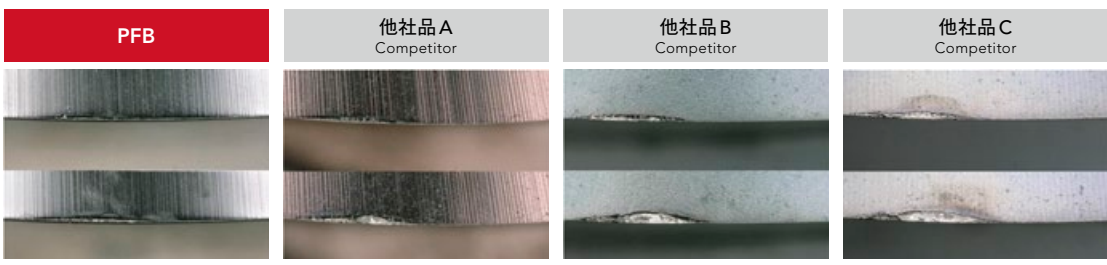
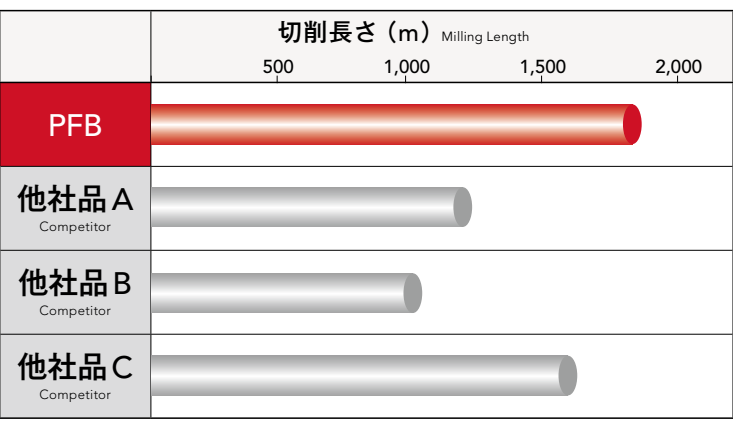

高硬度鋼 (60HRC)において優れた耐久性を発揮 Excellent durability in high-hardness steels (60 HRC)

使用工具 Tool	PFB-R200SS20-L180CS (R10×2刃)
使用インサート(材種) Insert (grade)	PFB200-HH(XP6703)
被削材 Work Material	SKD11相当品 (60HRC) Equivalent
加工方法 Cutting Method	形状加工 Profile Milling
切削速度 Cutting Speed	200m/min (3,184min ⁻¹)
送り速度 Feed	1,274mm/min (0.2mm/t)
切込深さ Depth of Cut	a _p =0.2mm Pf=0.3mm
切削油剤 Coolant	なし(エアブロー) Air Blow
使用機械 Machine	横形マシニングセンタ(BT50) Horizontal Machining Center

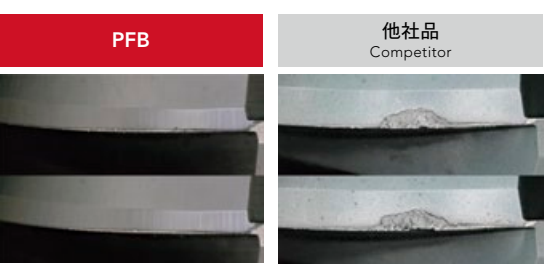
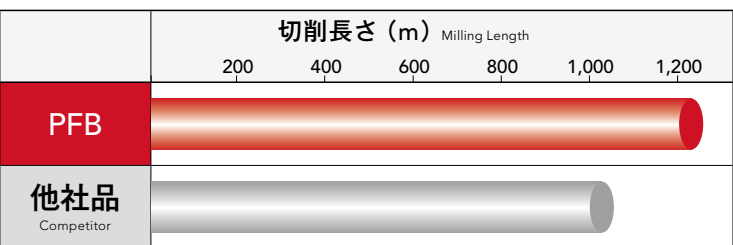

仕上げ用ボールエンドミル

Ball End Mill for Finishing

バレル型・レンズ型インサート

Barrel Type & Lens Type Inserts

■独自の形状で、滑らかな加工面と高能率加工を実現

Original geometry that enables smooth machined surface and higher cutting efficiency

バレル型 (PFB-BR) Barrel Type

さらい刃
Wiper edge

コーナR
Corner R



外周R
Peripheral edge R

■ 勾配面の等高線加工
Contour milling of vertical slope

■ 底面の平坦部加工
Flat bottom milling

■ 最大17.1°までの
勾配面に適用
(下表を参照)
※3軸加工の場合
Applicable to vertical slopes up
to 17.1° (see table below)
* For 3-axis machining



勾配角
Vertical slope angle

■ 使用可能な最大勾配角
Applicable maximum vertical slope angle

φ10 (R15)	16.6°
φ12 (R18)	17.1°
φ16 (R24)	15.8°
φ20 (R30)	16.6°
φ25 (R37.5)	16.6°
φ32 (R48)	16.7°

レンズ型 (PFB-LZ) Lens Type

底刃R
Bottom edge R

中心フラット
Flat center

コーナR
Corner R



■ 傾斜面の倣い加工
Copy milling of horizontal slope

■ 曲面の倣い加工
Copy milling of curved surface

■ 最大15.7°までの
傾斜面に適用
(下表を参照)
※3軸加工の場合
Applicable to horizontal slopes
up to 15.7° (see table below)
* For 3-axis machining

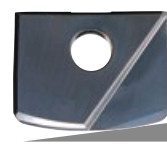

傾斜角
Horizontal slope angle

■ 使用可能な最大傾斜角
Applicable maximum horizontal slope angle

φ10 (R15)	15°
φ12 (R18)	15.7°
φ16 (R24)	14.4°
φ20 (R30)	14.7°
φ25 (R37.5)	15.1°
φ32 (R48)	15.4°

■用途に合わせて選べるインサート材種

Insert grade can be selected according to application

XP3225材種 Grade

- ・幅広い被削材の安定加工向け
- ・優れた潤滑性、耐摩耗性
- ・For stable milling of a wide variety of work materials
- ・Excellent lubricity and wear resistance

XP3310材種 Grade

- ・高硬度鋼・鋳鉄の乾式加工に最適
- ・優れた耐熱性、耐摩耗性
- ・Ideal for dry milling of high hardened steel and cast iron
- ・Excellent heat and wear resistance



Inserts

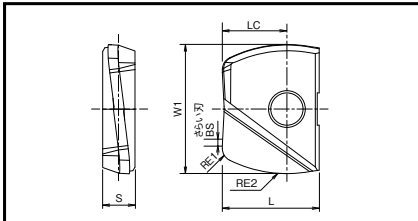

インサート Inserts

単位:mm Unit:mm

形状 Appearance	呼び Designation	切れ刃数 No. of Cutting Edges	インサート寸法 Insert Size							適用ボディ タイプ Applicable Body	コーティング材種 Grade of Coated Materials		標準価格 (Yen)
			最外径 W1	外周R RE2	コーナR RE1	最外径 位置 LC	厚さ S	L	ざらい刃 (副切れ刃) BS		XP3225	XP3310	
汎用タイプ Multi-purpose Type	PFB100R150-BR-ST	2	10	15	1	5	2.6	8.5	0.3	③	NEW 7820071		8,240
	PFB120R180-BR-ST		12	18	1	6	3	10	0.3	④	NEW 7820072		8,710
	PFB160R240-BR-ST		16	24	2	8	4	12	0.5	⑤	NEW 7820073		9,010
	PFB200R300-BR-ST		20	30	2	10	5	15	0.5	⑥	NEW 7820074		9,550
	PFB250R375-BR-ST		25	37.5	2.5	12.5	6	18.5	0.5	⑦	NEW 7820075		10,500
	PFB320R480-BR-ST		32	48	3	16	7	23.5	0.5	⑨	NEW 7820076		13,200
刃先強化タイプ Reinforced Edge Type	PFB100R150-BR-SH	2	10	15	1	5	2.6	8.5	0.3	③		NEW 7820081	8,240
	PFB120R180-BR-SH		12	18	1	6	3	10	0.3	④		NEW 7820082	8,710
	PFB160R240-BR-SH		16	24	2	8	4	12	0.5	⑤		NEW 7820083	9,010
	PFB200R300-BR-SH		20	30	2	10	5	15	0.5	⑥		NEW 7820084	9,550
	PFB250R375-BR-SH		25	37.5	2.5	12.5	6	18.5	0.5	⑦		NEW 7820085	10,500
	PFB320R480-BR-SH		32	48	3	16	7	23.5	0.5	⑨		NEW 7820086	13,200

シャンクホルダ、部品については p.200 ~ p.202 をご覧下さい。
See p.200-p.202 for shank holders and accessories.

仕上げ用ボールエンドミル バレル型(PFB-BR)・レンズ型(PFB-LZ)

Ball End Mill for Finishing Barrel Type · Lens Type

CADデータダウンロードサイト

Website with CAD data for download

- ・ ISO13399に準拠したDXF/STEPデータ
- ・ DXF / STEP data conforming to ISO13399

- ・ パソコン、スマートフォンからご利用可能
- ・ Accessible from desktop computers and smartphones

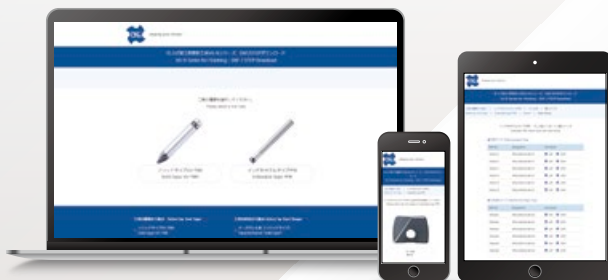

CADデータイメージ

Visual image of CAD data

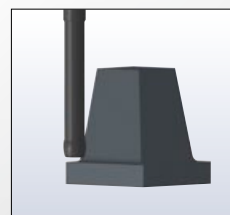

https://www.osg.co.jp/media_dl/vu-r_dl/

QRコードから簡単アクセス!
Easy access from QR code!

Phoenix

仕上げ用ボールエンドミル
Finishing Ball End Mill

レンズ型(PFB-LZ)

Lens Type Tool

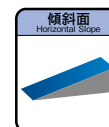
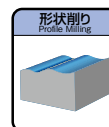

Inserts

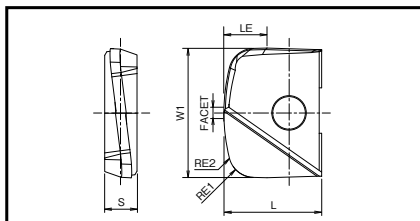

インサート Inserts

単位:mm Unit:mm

形状 Appearance	呼び Designation	切れ刃数 No. of Cutting Edges	インサート寸法 Insert Size							適用ボディ タイプ Applicable Body	コーティング材種 Grade of Coated Materials		標準価格 (Yen)
			最外径 W1	底刃R RE2	コーナR RE1	外周刃長 LE	厚さ S	L	中心 フラット幅 FACET		XP3225	XP3310	
汎用タイプ Multi-purpose Type	PFB100R150-LZ-ST	2	10	15	1	3.3	2.6	8.5	0.75	③	NEW 7820091		8,240
	PFB120R180-LZ-ST		12	18	1	4	3	10	0.75	④	NEW 7820092		8,710
	PFB160R240-LZ-ST		16	24	2	5.3	4	12	1	⑤	NEW 7820093		9,010
	PFB200R300-LZ-ST		20	30	2	6.7	5	15	1.75	⑥	NEW 7820094		9,550
	PFB250R375-LZ-ST		25	37.5	2.5	8.3	6	18.5	1.75	⑦	NEW 7820095		10,500
	PFB320R480-LZ-ST		32	48	3	10.7	7	23.5	2	⑨	NEW 7820096		13,200
刃先強化タイプ Reinforced Edge Type	PFB100R150-LZ-SH	2	10	15	1	3.3	2.6	8.5	0.75	③		NEW 7820101	8,240
	PFB120R180-LZ-SH		12	18	1	4	3	10	0.75	④		NEW 7820102	8,710
	PFB160R240-LZ-SH		16	24	2	5.3	4	12	1	⑤		NEW 7820103	9,010
	PFB200R300-LZ-SH		20	30	2	6.7	5	15	1.75	⑥		NEW 7820104	9,550
	PFB250R375-LZ-SH		25	37.5	2.5	8.3	6	18.5	1.75	⑦		NEW 7820105	10,500
	PFB320R480-LZ-SH		32	48	3	10.7	7	23.5	2	⑨		NEW 7820106	13,200

シャンクホルダ、部品については p.200 ~ p.202 をご覧下さい。
See p.200-p.202 for shank holders and accessories.

仕上げ用ボールエンドミル バレル型(PFB-BR)・レンズ型(PFB-LZ)

Ball End Mill for Finishing Barrel Type · Lens Type

CADデータダウンロードサイト

Website with CAD data for download

- ・ISO13399に準拠したDXF/STEPデータ
- ・DXF / STEP data conforming to ISO13399

- ・パソコン、スマートフォンからご利用可能
- ・Accessible from desktop computers and smartphones

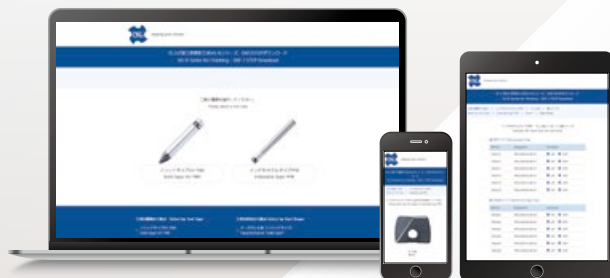

CADデータイメージ
Visual image of CAD data



https://www.osg.co.jp/media_dl/vu-r_dl/

QRコードから簡単アクセス!
Easy access from QR code!

Cutting Condition

■被削材別推奨材質

Recommended Materials by Insert Type

◎第一推奨材質 Best
○第二推奨材質 Good

インサート材種 Insert Grades	形状 Appearance	P	M	K	N	S	H
XP3225	PFB-ST	◎	○			○	
XP3310	PFB-SH			◎			◎

■切削条件基準表 Cutting Conditions

バレル型 PFB-BR Barrel Type Tool

	被削材 Work Material	引張強さ・硬さ Tensile Strength・Hardness	切削速度 Vc(m/min) Cutting Speed	切込深さの目安 Depth of Cut		1刃当たりの送り fz (mm/t) カッタ径 DC		
				加工ピッチ Pitch(mm)	切込深さ Depth of Cut (mm)	φ10, 12	φ16, 20	φ25, 32
P	軟鋼、低炭素鋼 (SS400, S10C) Mild Steel, Carbon Steel	~180HB	300 (200~800)	カスプハイト量 による (下図参照) Based on cusp height (See chart below)	~0.2	0.12	0.14	0.18
	炭素鋼、合金鋼 (S50C, SCM440) Carbon Steel, Alloy Steel	~280HB	300 (200~800)		~0.2	0.1	0.12	0.14
	ダイス鋼 (SKD61, SKD11) Die Steel	~280HB	250 (150~600)		~0.2	0.1	0.12	0.14
M	ステンレス鋼 (SUS304, SUS420) Stainless Steel	~250HB	250 (150~650)		~0.2	0.12	0.14	0.17
K	铸铁 (FC250) Cast Iron	~300N/mm ²	400 (300~800)		~0.2	0.14	0.18	0.22
	ダクタイル铸铁 (FCD400) Ductile Cast Iron	~600N/mm ²	300 (200~800)		~0.2	0.12	0.14	0.18
S	超耐熱合金(湿式) (Inconel 718) Superalloy (Wet)	-	50 (25~80)		~0.15	0.05	0.06	0.06
	チタン合金(湿式) (Ti-6Al-4V) Titanium Alloy (Wet)	-	90 (40~120)		~0.2	0.08	0.11	0.13
H	プリハードン鋼 (NAK80, STAVAX) Pre-hardened Steel	40~43HRC	200 (100~350)		~0.15	0.07	0.08	0.1
	ダイカスト鋼 (DAC-MAGIC, DH31) Die Cast Steel	43~48HRC	180 (90~350)		~0.15	0.06	0.07	0.07
	調質鋼 (SKD11) Hardened Steel	50~60HRC	150 (100~300)	~0.1	0.06	0.07	0.07	

上記の数値は実切削速度における一般的な値を示したものです。加工環境に合わせて適宜調整して下さい。
The above cutting conditions are to be used as general guidelines. Adjustments may be necessary depending on actual cutting conditions.

■理論上のカスプハイト

Theoretical Cusp Height

バレル型 (PFB-BR) Barrel Type Tool

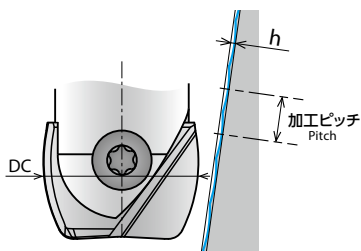

$$h = 0.5 \times (2 \times RE2 - \sqrt{(2 \times RE2)^2 - P^2})$$

h: カスプハイト Cusp height P: 加工ピッチ Pitch RE2: 外周R peripheral edge R

カスプハイトと加工ピッチ Cusp Height and Pitch

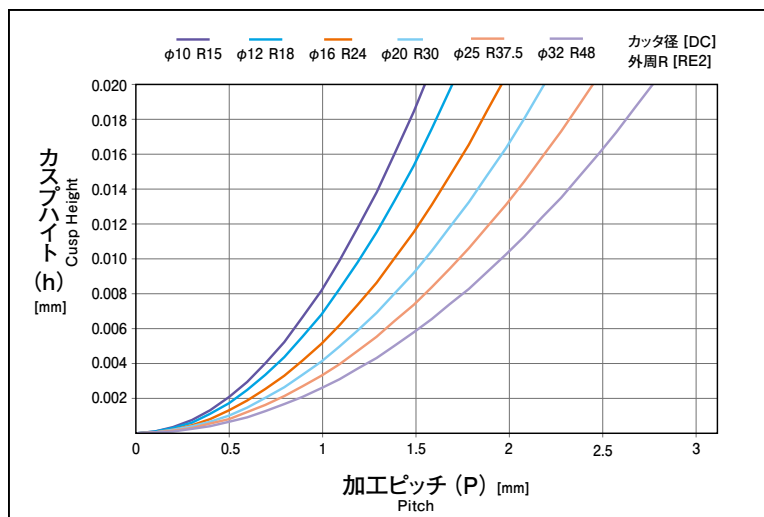

■被削材別推奨材質

Recommended Materials by Insert Type

◎第一推奨材質 Best
○第二推奨材質 Good

インサート材種 Insert Grades	形状 Appearance	P	M	K	N	S	H
XP3225	PFB-ST	◎	○			○	
XP3310	PFB-SH			◎			◎

■切削条件基準表 Cutting Conditions

レンズ型(PFB-LZ) Lens Type Tool

	被削材 Work Material	引張強さ・硬さ Tensile Strength・Hardness	切削速度 Vc(m/min) Cutting Speed	切込深さの目安 Depth of Cut		1刃当たりの送り fz (mm/t) カッタ径 DC		
				加工ピッチ Pitch(mm)	切込深さ Depth of Cut (mm)	φ10, 12	φ16, 20	φ25, 32
P	軟鋼、低炭素鋼 (SS400, S10C) Mild Steel, Carbon Steel	~180HB	300 (200~800)	カスプハイト量 による (下図参照) Based on cusp height (See chart below)	~0.2	0.12	0.14	0.18
	炭素鋼、合金鋼 (S50C, SCM440) Carbon Steel, Alloy Steel	~280HB	300 (200~800)		~0.2	0.1	0.12	0.14
	ダイス鋼 (SKD61, SKD11) Die Steel	~280HB	250 (150~600)		~0.2	0.1	0.12	0.14
M	ステンレス鋼 (SUS304, SUS420) Stainless Steel	~250HB	250 (150~650)		~0.2	0.12	0.14	0.17
K	铸铁 (FC250) Cast Iron	~300N/mm ²	400 (300~800)		~0.2	0.14	0.18	0.22
	ダクタイル铸铁 (FCD400) Ductile Cast Iron	~600N/mm ²	300 (200~800)		~0.2	0.12	0.14	0.18
S	超耐熱合金(湿式) (Inconel 718) Superalloy (Wet)	-	50 (25~80)		~0.15	0.05	0.06	0.06
	チタン合金(湿式) (Ti-6Al-4V) Titanium Alloy (Wet)	-	90 (40~120)		~0.2	0.08	0.11	0.13
H	プリハードン鋼 (NAK80, STAVAX) Pre-hardened Steel	40~43HRC	200 (100~350)		~0.15	0.07	0.08	0.1
	ダイカスト鋼 (DAC-MAGIC, DH31) Die Cast Steel	43~48HRC	180 (90~350)		~0.15	0.06	0.07	0.07
	調質鋼 (SKD11) Hardened Steel	50~60HRC	150 (100~300)		~0.1	0.06	0.07	0.07

・上記の数値は実切削速度における一般的な値を示したものです。加工環境に合わせて適宜調整して下さい。
The above cutting conditions are to be used as general guidelines. Adjustments may be necessary depending on actual cutting conditions.

■理論上のカスプハイト

Theoretical Cusp Height

レンズ型 (PFB-LZ) Lens Type Tool

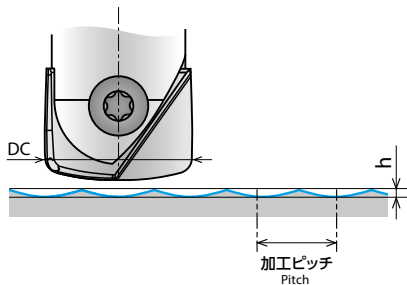

$$h = 0.5 \times (2 \times RE2 - \sqrt{(2 \times RE2)^2 - P^2})$$

h: カスプハイト Cusp height
P: 加工ピッチ Pitch
RE2: 底刃R Bottom edge R

カスプハイトと加工ピッチ Cusp Height and Pitch

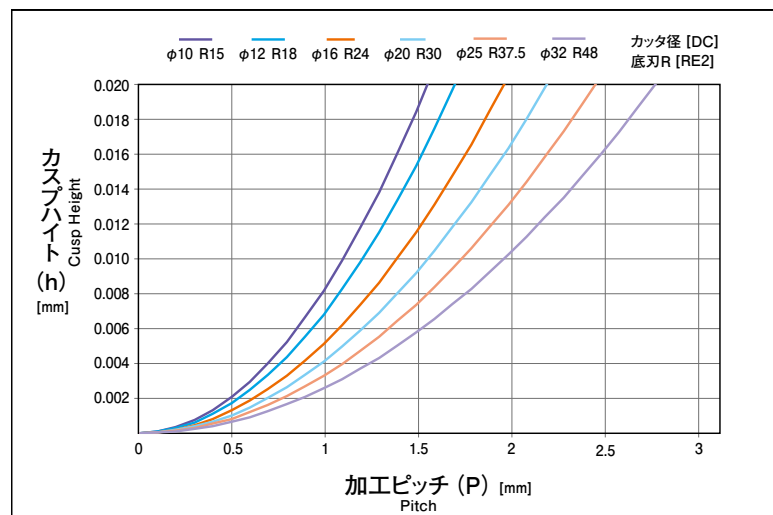

Cutting Data

加工データ Cutting Data

バレル型(PFB-BR)によるモールドベース勾配面の3軸仕上げ加工 3-axis finishing of mold base vertical slope by barrel type tool (PFB-BR)

使用工具 Tool	インサート: PFB320R480-BR-ST R48 Insert シャンク: PFB-R320SS32-LL300CS Shank	従来品 $\phi 40 \times R3$ (肩削りカッタ) Conventional (Shoulder Cutter)
被削材 Work Material	FCD550R	
切削速度 Cutting Speed	200m/min (1,990min ⁻¹)	125m/min (995min ⁻¹)
送り速度 Feed	600mm/min (0.15mm/t)	700mm/min
加工ピッチ Pitch	0.7mm	0.35mm
切込深さ Depth of Cut	0.3mm	0.3mm
工具突出し量 Overhang Length	176mm	
切削油剤 Coolant	なし(エアブロー) Air Blow	
加工時間 Machining time	2時間12分8秒 2Hours 12Minutes 8Seconds	5時間39分55秒 5Hours 39Minutes 55Seconds
加工面 Machined surface	カスプハイトほぼ同設定 Set to almost the same cusp height	
使用機械 Machine	横形マシニングセンタ(BT50) Horizontal Machining Center	

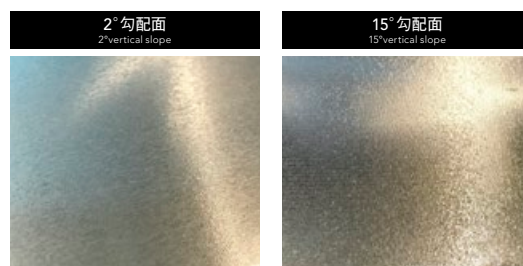
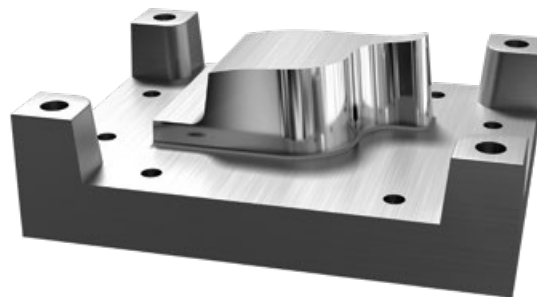

加工ピッチを従来品の2倍に設定。
加工効率を約30%上げた状態で、
仕上げ面は両勾配面ともに極めて良好であった。

The pitch is set to twice that of conventional tool.
The finished surfaces are extremely satisfactory for both vertical slopes, with the processing efficiency increased by about 30%.

バレル型(PFB-BR)によるダイカスト金型(エンジンケース)の3軸仕上げ加工 3-axis finishing of die casting mold (engine case) by barrel type tool (PFB-BR)

使用工具 Tool	インサート: PFB200R300-BR-ST R30 Insert シャンク: PFB-R200SF10 Shank	従来品 R10 (ボール形状) Conventional (Ball Type)	他社品 R20 (バレル・レンズ型) Competitor (Barrel-Lens Type)
被削材 Work Material	SKD61 (45HRC)		
切削速度 Cutting Speed	150m/min (2,387min ⁻¹)		
送り速度 Feed	477mm/min (0.1mm/t)		
加工ピッチ Pitch	1.01mm	0.59mm	0.86mm
切込深さ Depth of Cut	0.1mm	0.1mm	0.1mm
工具突出し量 Overhang Length	110mm		
切削油剤 Coolant	水溶性切削油剤 Water-Soluble		
加工時間 Machining time	27分20秒 27Minutes 20Seconds	46分19秒 46Minutes 19Seconds	31分53秒 31Minutes 53Seconds
カスプハイト Cusp height	0.005mm		
底面粗さ Machined surface	Ra=0.49 μ m Rz=2.1 μ m	Ra=0.88 μ m Rz=3.4 μ m	Ra=0.65 μ m Rz=2.8 μ m
使用機械 Machine	立形マシニングセンタ(HSK63) Vertical Machining Center		

バレルのR30により、加工ピッチを大きくできるため、時間短縮が可能となった。
またバレル型(PFB-BR)が有するざらい刃により底面は高精度に仕上がった。
かつ、0.6DC(12mm)の底面加工ピッチで、ボール形状や他社バレル・レンズ型よりも大幅な時間短縮を実現した。

Processing time can be reduced with the larger pitch of the barrel type tool's R30.
In addition, the wiper edge of the barrel type tool (PFB-BR) enables higher quality of the bottom surface.

Moreover, with the bottom pitch of 0.6 DC (12 mm), processing time can be significantly reduced compared to ball shape and other competitors' barrel and lens type tools.

インサート形状によるパスの違い Difference in path based on insert shape

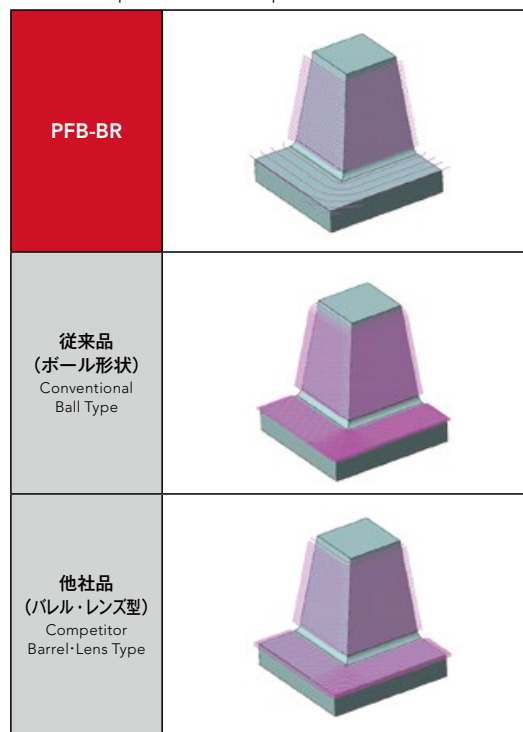

Cutting Data

■加工データ Cutting Data

■ バレル型(PFB-BR) によるモールドベース勾配面の3軸仕上げ加工 3-axis finishing of mold base vertical slope by barrel type tool (PFB-BR)

使用工具 Tool	インサート: PFB200R300-BR-ST R30 Insert シャンク: 特殊品 Shank Special Order	従来品 φ40×R3 (肩削りカッタ) Conventional (Shoulder Cutter)
被削材 Work Material	FCD550R	
切削速度 Cutting Speed	182m/min (2,900min ⁻¹)	113m/min (900min ⁻¹)
送り速度 Feed	650mm/min (0.11mm/t)	500mm/min
加工ピッチ Pitch	1mm	0.35mm
切込深さ Depth of Cut	0.6mm	0.6mm
工具突出し量 Overhang Length	145mm	
切削油剤 Coolant	なし(エアブロー) Air Blow	
加工時間 Machining time	9時間 9Hours	22時間 22Hours
加工面 Machined surface	カスプハイトほぼ同設定 Set to almost the same cusp height	
使用機械 Machine	横形マシニングセンタ(BT50) Horizontal Machining Center	

大幅な能率アップが可能となった。
従来品は1ワークでインサート交換のところ、2ワーク以上の耐久が得られた。

Achieved significant increase in efficiency.
With the conventional tool, the insert has to be replaced after milling one workpiece. The PFB-BR, however, can complete two or more workpieces before having to be replaced.

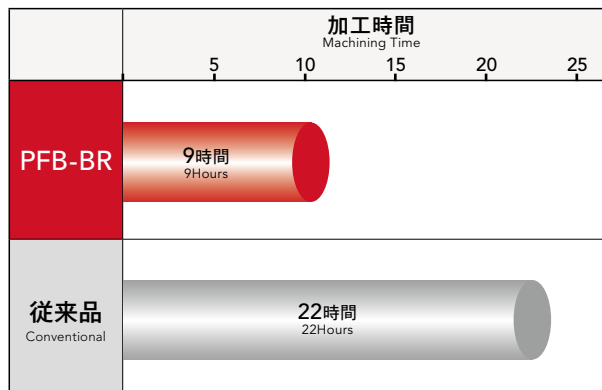

■加工面

Machined surface

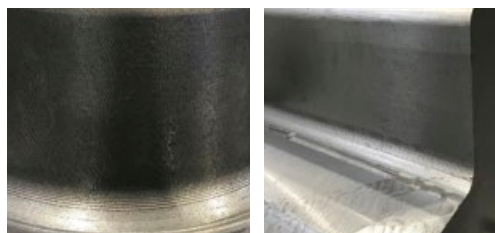

■ バレル型(PFB-BR) による固定ダイス勾配面の3軸仕上げ加工 3-axis finishing of fixed die vertical slope by barrel type tool (PFB-BR)

使用工具 Tool	インサート: PFB200R300-BR-SH R30 Insert シャンク: PFB-R200SS20-L180CS Shank	従来品 φ20×R3 (ラジラス形状) Conventional (Radius Type)
被削材 Work Material	DH31S 相当品 Equivalent	
切削速度 Cutting Speed	220m/min (3,510min ⁻¹)	
送り速度 Feed	983mm/min (0.14mm/t)	1,750mm/min (0.25mm/t)
加工ピッチ Pitch	0.8mm	0.35mm
切込深さ Depth of Cut	0.15mm	0.15mm
工具突出し量 Overhang Length	98mm	
切削油剤 Coolant	なし(エアブロー) Air Blow	
加工方法 Cutting Method	等高線仕上げ加工 Contour line finish milling	
加工時間 Machining time	28分40秒 28Minutes 40Seconds	45分7秒 45Minutes 7Seconds
カスプハイト Cusp height	0.002mm	0.005mm
使用機械 Machine	横形マシニングセンタ(BT50) Horizontal Machining Center	

従来品ラジラス型インサートでは、加工ピッチが小さいため、1ワーク持たずに耐久となった。バレル型インサート(PFB-BR)では、加工ピッチを大きくできるため、切削距離が短くなり工具交換なしで1ワーク加工が可能となった。

精度も良く出ており、磨き無しで済むレベルであった。

The conventional radius type insert needs to be replaced before finishing one workpiece due to small pitch. With the barrel type insert (PFB-BR), because the cutting distance became shorter due to the larger pitch, it was possible to complete cutting one workpiece without replacing the tool. The level of precision was also high enough to eliminate polishing.

■ PFB-BR 仕上げ面

Finished surface by PFB-BR



加工面は指が写り込むぐらい良好。

The machined surface quality was so superior that a clear reflection can be seen.

■ 工具損傷状態

Wear Comparison

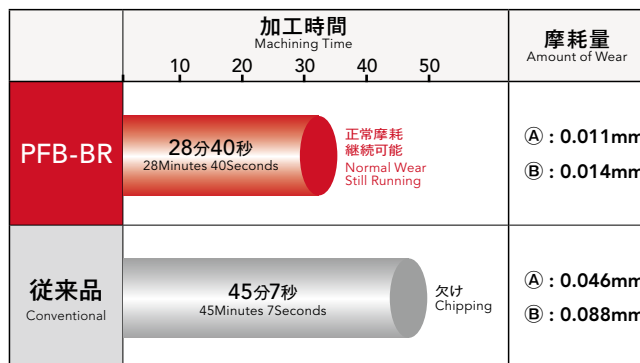
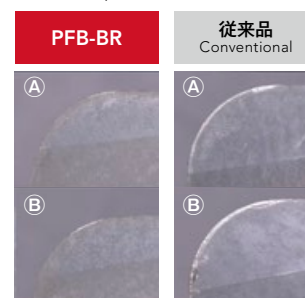

バレル型(PFB-BR)による大型金型の仕上げ加工 Finishing of large die by barrel type tool (PFB-BR)

使用工具 Tool	インサート: PFB320R480-BR-SH R48 Insert シャンク: PFB-R320SS32-LL300CS Shank	従来品 R6 (ボール形状) Conventional (Ball Type)
被削材 Work Material	SC410	
切削速度 Cutting Speed	250m/min (2,500min ⁻¹)	101m/min (2,680min ⁻¹)
送り速度 Feed	800mm/min (0.16mm/t)	1,800mm/min
加工ピッチ Pitch	3mm	2mm
カスプハイト Cusp height	0.023mm	0.084mm
工具突出し量 Overhang Length	175mm	
切削油剤 Coolant	なし(エアブロー) Air Blow	
加工時間 Machining time	1.5時間×18ワーク(27時間) 1.5Hours×18Work	1時間×18ワーク(18時間) 1Hours×18Work
工具使用本数 Number of tools	3本 3 tools	6本 6 tools
磨き加工時間 Polishing time	4時間×18ワーク(72時間) 4Hours×18Work	6時間×18ワーク(108時間) 6Hours×18Work
合計加工時間 Total machining time	99時間 99Hours	126時間 126Hours
使用機械 Machine	門形マシニングセンタ(BT50) Double Column Machining Center	

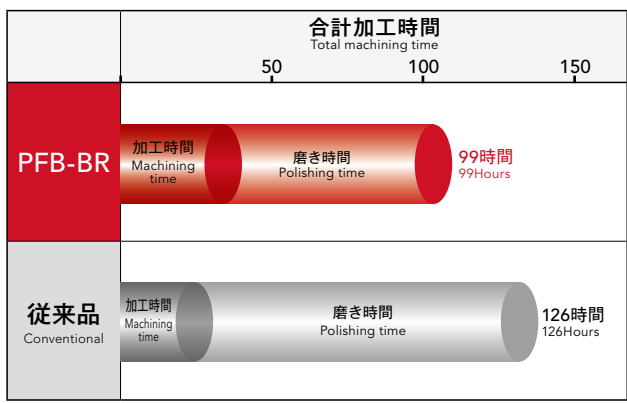

バレル大Rの効果により滑らかで山の少ない仕上げ面となった。山が少なくなった事で、磨き加工時間が大幅に短縮でき、トータルの仕上げに要する時間が大幅に短縮された。加工ピッチを大きくする事で、切削距離も短くなり工具本数も減らす事が出来た。

Smooth and considerably high quality surface is achieved due to the effect of the large barrel R. As the surface becomes smoother, polishing time can be significantly reduced and thus the total time required for finishing can also be significantly reduced. By making the pitch larger, the cutting distance is shortened, minimizing the number of tools required for processing.

レンズ型(PFB-LZ)によるブレード5軸仕上げ加工 5-axis finishing of blade with lens type tool (PFB-LZ)

使用工具 Tool	インサート: PFB200R300-LZ-ST R30 Insert シャンク: PFB-R200SF10 Shank	他社レンズ工具 R20 Competitor Lens Tool
被削材 Work Material	SUS430	
切削速度 Cutting Speed	500m/min (7,961min ⁻¹)	
送り速度 Feed	2,388mm/min (0.15mm/t)	2,388mm/min (0.1mm/t)
加工ピッチ Pitch	1.24mm	1.01mm
切込深さ Depth of Cut	0.2mm	0.2mm
工具突出し量 Overhang Length	90mm	
切削油剤 Coolant	水溶性切削油剤 Water-Soluble	
カスプハイト Cusp height	0.006mm	
加工時間 Machining time	196分 196Minutes	244分 244Minutes
加工数 Number of processes	12E	
使用機械 Machine	ブレード加工専用機 Turbine blade processing machine	

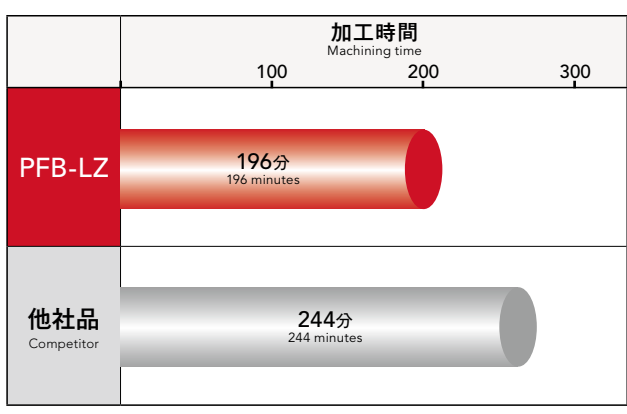

PFB-LZ R30を使用し、加工ピッチを大きくする事で、加工時間を短縮することができた。

By using PFB-LZ R30 to make the pitch larger, machining time is shortened.

Cutting Data

■加工データ Cutting Data

■レンズ型(PFB-LZ)によるブレード翼面5軸加工仕上げ 5-axis finishing of turbine blade with lens type tool (PFB-LZ)

使用工具 Tool	インサート: PFB200R300-LZ-ST R30 <small>Insert</small> シャンク: PFB-R200SS20-L180CS <small>Shank</small>		従来品 R10 (ボール形状) Conventional (Ball Type)
被削材 Work Material	SUS430		
切削速度 Cutting Speed	420m/min (6,687min ⁻¹)		
送り速度 Feed	5,350mm/min(0.4mm/t)		
加工ピッチ Pitch	0.866mm	0.5mm	
切込深さ Depth of Cut	0.2mm	0.2mm	
工具傾き Tilt angle of tool	15°		
工具突出し量 Overhang Length	90mm		
切削油剤 Coolant	水溶性切削油剤 Water-Soluble		
加工時間 Machining time	9分25秒 9Minutes 25Seconds	16分30秒 16Minutes 30Seconds	
カスプハイト Cusp height	0.003mm		
使用機械 Machine	立形マシニングセンタ 5軸加工機 (BT50) Vertical machining center for 5-axis machining		

大幅な時間短縮が可能となった。

Significant processing time reduction is achieved.

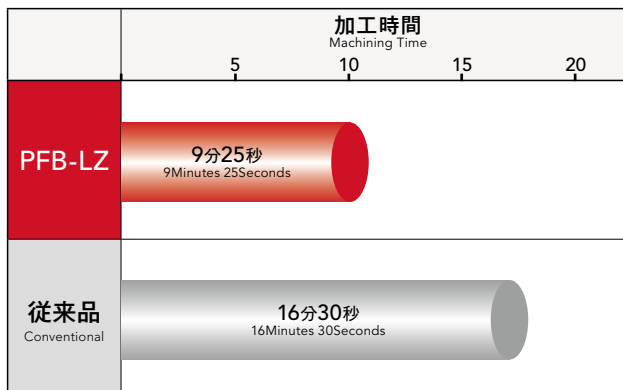

■工具軌跡の違い

Difference in tool path

PFB-LZ

従来品 (ボール形状)
Conventional (Ball Type)

加工能率
Machining
efficiency
170%

■レンズ型(PFB-LZ)による大型金型部品の仕上げ加工(ワークの機械載せ替え作業削減) Finishing of large die parts with lens type tool (PFB-LZ) (workpiece mounting process reduction)

使用工具 Tool	インサート: PFB320R480-LZ-SH R48 <small>Insert</small> シャンク: PFB-R320SS32-LL300CS <small>Shank</small>	
被削材 Work Material	PX5	
切削速度 Cutting Speed	226m/min (2,250min ⁻¹)	
送り速度 Feed	650mm/min(0.15mm/t)	
加工ピッチ Pitch	0.8mm	
切込深さ Depth of Cut	0.2mm	
工具突出し量 Overhang Length	176mm	
切削油剤 Coolant	なし(エアブロー) Air Blow	
加工時間 Machining time	2時間30分 2Hours 30Minutes	
カスプハイト Cusp height	0.002mm	
使用機械 Machine	立形マシニングセンタ (BT50) Vertical Machining Center	

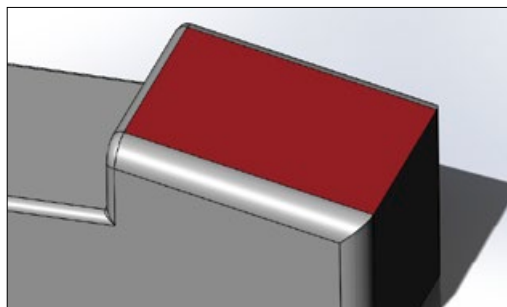

ワーク全体の一部分のイメージです。(4°傾斜面)
Illustration of a portion of the workpiece (4°horizontal slope)

■加工面

Machined surface



従来は、荒加工を立形マシニングセンタで行った後、仕上げ面を横形マシニングセンタに載せ替え、イケールを4°傾けて正面フライスカッタで仕上げ加工を行っていた。レンズ型(PFB-LZ)を使用する事で、ワークの載せ替え無く加工を行えるようになった。段取り時間を大幅削減しコストダウンとなった。

Conventionally, after roughing was performed by a vertical machining center, the finished surface would be transferred to a horizontal machining center for finishing by face milling with the tooling block tilted at 4°. By using the lens type tool (PFB-LZ), work setup time is greatly reduced to achieve large cost reduction.

お客様の加工に合わせた特殊品を承っております

Tailored special tools are available to accommodate specific machining requirement.

形状 Appearance

例)
Example

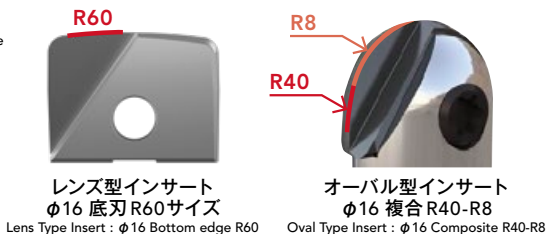

表面処理 Surface Treatment

例)
Example

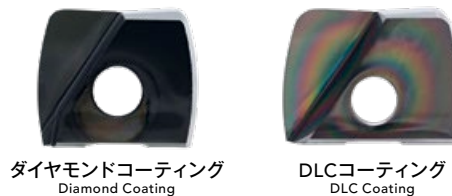

ヘッド交換式タイプ Exchangeable Head End Mill

例)
Example

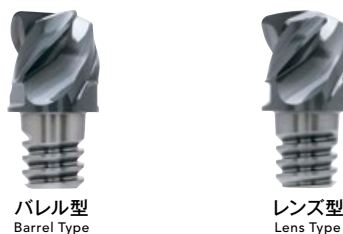

詳細は当社営業までお問い合わせください。 Please contact your local sales representative for details.

仕上げ用ボールエンドミル Ball End Mill for Finishing **ポリボール** 複合R形状異形工具 PolyBall

Composite Radius Shape Type Variant Shape Tool

**ボールエンドミルと同じ感覚で
使用できることが大きな特長です。**

A major feature is that it can be used just like any ball end mill.

傾斜・曲面の複雑形状に対して加工面品位の向上、
加工時間短縮を実現します。
Improves machined surface quality and reduces machining time for complex shapes
such as inclined and curved surfaces.

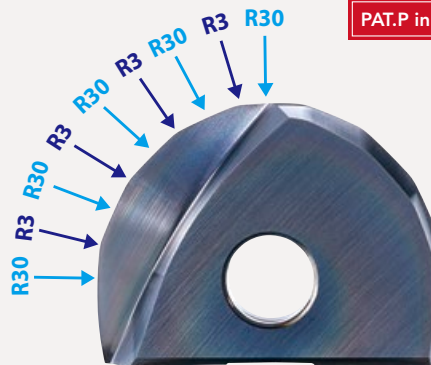

※Rの組合せは一例です。
Example of combination of Rs.

様々な傾斜面に対応可能 Compatible with various inclined surfaces

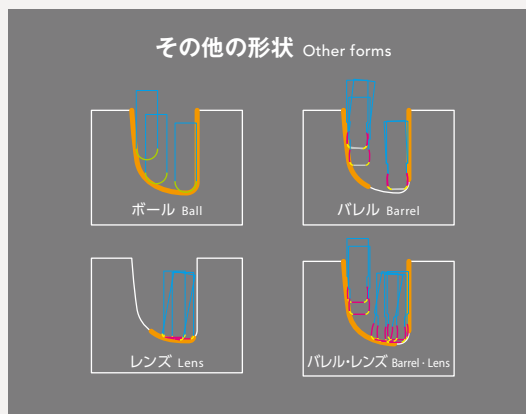
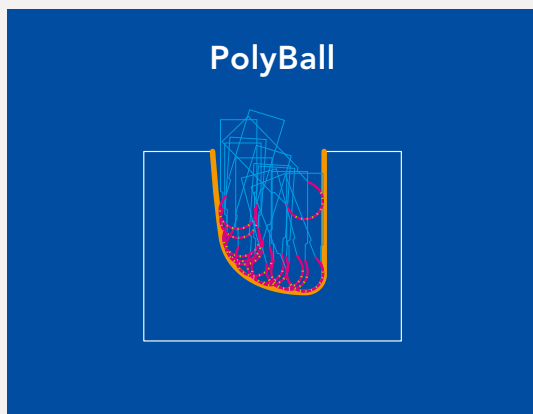

加工範囲
Machined area

お客様の加工に合わせた特殊品を承っております。詳細は当社営業までお問い合わせください。
Tailored special tools are available to accommodate specific machining requirement. Please contact your sales representative for details.

» Phoenix PFR

仕上げ用ラジラスエンドミル
Finishing Radius End Mill

Phoenix Finishing Radius End Mill

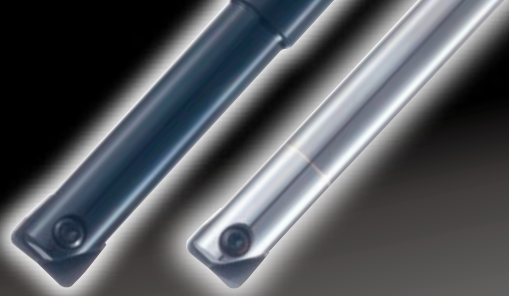

■インサートの特長

Features of Insert

- ・高いコーナR精度 $\pm 8 \mu\text{m}$
High corner radius precision
- ・外径許容差 -0.02mm
Tolerance for outer diameter
- ・底刃にさらい刃付き
Wiper insert at the end cutting edge
- ・特殊処理を施すことにより
刃先強度が向上
Strong cutting edge by the special processing

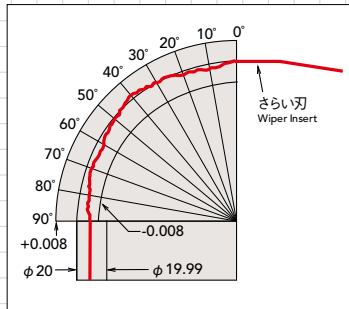

■高剛性ボディ

Highly rigid cutter body

- 安定加工を実現する高精度・高剛性ボディ
Highly accurate and rigid cutter body for stable milling
- PFBボディの流用が可能
(立壁など切りくずの噛みこみが発生しやすい部分の加工には、クリアランスの大きなPFBボディの使用を推奨)
Inserts can be attached to PFB cutter body (For milling standing wall, PFB body, which has a bigger clearance, is recommended).

【仕上げ面粗さ曲線】 Finished surface roughness curve

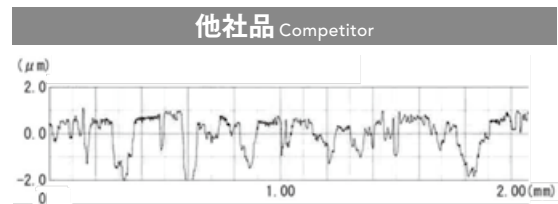
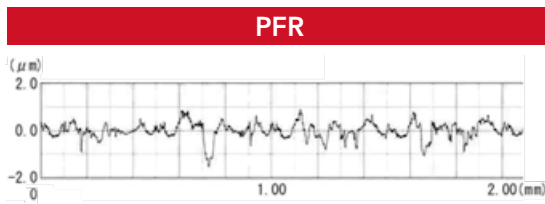

PFR-ST

- 軟鋼から耐熱合金まで幅広い被削材をカバー
- 突出しの長い加工(L/D=5以上)に最適
- 切れ味と食い付き性に優れたポジ刃形
- Applicable to a wide variety of work materials from mild steel to HRSA
- Ideal for milling with long overhangs (L/D ≥ 5)
- Positive rake angle with excellent sharpness and bite

XP3225材種 Grade

- ・幅広い被削材の安定加工向け
- ・優れた潤滑性、耐摩耗性
- ・For stable milling of a wide variety of work materials
- ・Excellent lubricity and wear resistance

PFR-SH

- 鋳鉄、ダクタイル鋳鉄、高硬度鋼用に最適
- 底刃の二次元ネガチャンファにより刃先強度が向上し、不安定な環境下でも安定加工が可能
- 耐摩耗性の高い超硬母材を採用
- For milling cast iron, ductile iron and HRSA
- High rigid cutting edge with two-dimensional negative chamfer, which is applicable to unstable machining conditions
- Highly resistant carbide material

XP3310材種 Grade

- ・高硬度鋼・鋳鉄の乾式加工に最適
- ・優れた耐熱性、耐摩耗性
- ・Ideal for dry milling of high hardened steel and cast iron
- ・Excellent heat resistance and wear resistance

PFR-D

- グラファイト加工に最適な切れ味重視の専用刃形
- 密着性に優れたダイヤモンドコーティング専用超硬母材を採用
- Sharp cutting edge specialized for milling graphite
- Highly adhesive carbide material for diamond coating

XC4505材種 Grade

- ・非鉄金属加工向け
- ・グラファイト加工に最適なダイヤモンドコーティング
- ・For milling nonferrous material
- ・Optimal diamond coating for milling graphite

Phoenix

仕上げ用ラジアスエンドミル
Finishing Radius End Mill

PFR

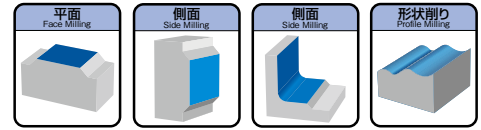

Specification

■形状寸法表 Specification

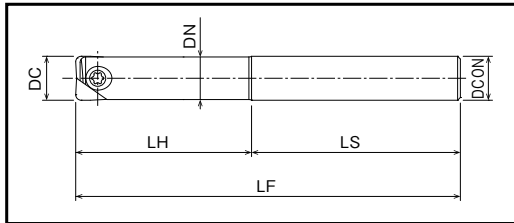

単位:mm Unit:mm

鋼シャンク Steel Shank

②	ツールNo. EDP No.	呼び Designation	外径 DC	全長 LF	有効長		刃数 ZEPF	シャンク径 DCON	シャンク長 LS	首径 DN	標準価格 (Yen)
					首下長 LH	L/D					
②	7832000	PFR-R080SS08-S120	8	120	36	4.5	2	8	84	7.5	25,600
③	7832001	PFR-R100SS10-S130	10	130	45	4.5	2	10	85	9.5	25,700
④	7832002	PFR-R120SS12-S130	12	130	54	4.5	2	12	76	11.5	27,800
⑤	7832003	PFR-R160SS16-S140	16	140	64	4	2	16	76	15.5	28,100
⑥	7832004	PFR-R200SS20-S160	20	160	80	4	2	20	80	19.5	28,300
⑦	7832005	PFR-R250SS25-S160	25	160	75	3	2	25	85	24.5	32,700
⑧	7832006	PFR-R300SS32-S170	30	170	90	3	2	32	80	29.5	57,500
⑨	7832007	PFR-R320SS32-S180	32	180	96	3	2	32	84	31.5	63,100

超硬シャンク ショートタイプ Carbide Shank, Short Type

単位:mm Unit:mm

①	ツールNo. EDP No.	呼び Designation	外径 DC	全長 LF	有効長		刃数 ZEPF	シャンク径 DCON	シャンク長 LS	首径 DN	標準価格 (Yen)
					首下長 LH	L/D					
①	7832029	PFR-R060SS06-S80CS	6	80	15	2.5	2	6	65	5.4	37,200
②	7832030	PFR-R080SS08-S100CS	8	100	20	2.5	2	8	80	7.5	39,300
③	7832031	PFR-R100SS10-S100CS	10	100	25	2.5	2	10	75	9.5	40,100
④	7832032	PFR-R120SS12-S110CS	12	110	30	2.5	2	12	80	11.5	47,000
⑤	7832033	PFR-R160SS16-S140CS	16	140	40	2.5	2	16	100	15.5	56,100
⑥	7832034	PFR-R200SS20-S160CS	20	160	50	2.5	2	20	110	19.5	79,800
⑦	7832035	PFR-R250SS25-S160CS	25	160	62.5	2.5	2	25	97.5	24.5	104,000
⑧	7832036	PFR-R300SS32-S170CS	30	170	75	2.5	2	32	95	29.5	132,000
⑨	7832037	PFR-R320SS32-S180CS	32	180	80	2.5	2	32	100	31.5	139,000

NEXT

Phoenix

仕上げ用ラジアスエンドミル

Finishing Radius End Mill

PFR

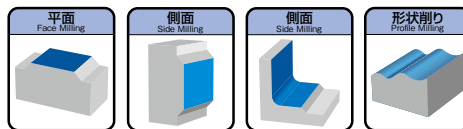

Specification

形状寸法表 Specification

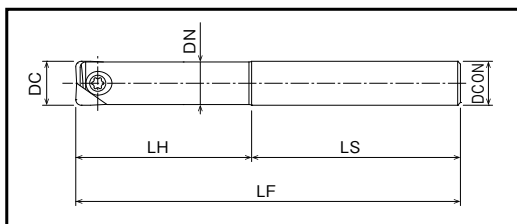

単位:mm Unit:mm

FROM

超硬シャンク ロングタイプ Carbide Shank, Long Type

①	ツールNo. EDP No.	呼び Designation	外径 DC	全長 LF	有効長		刃数 ZEPF	シャンク径 DCON	シャンク長 LS	首径 DN	標準価格 (Yen)
					首下長 LH	L/D					
①	7832039	PFR-R060SS06-L100CS	6	100	30	5	2	6	70	5.4	40,600
②	7832040	PFR-R080SS08-L120CS	8	120	40	5	2	8	80	7.5	42,700
③	7832041	PFR-R100SS10-L130CS	10	130	50	5	2	10	80	9.5	43,300
④	7832042	PFR-R120SS12-L140CS	12	140	60	5	2	12	80	11.5	50,600
⑤	7832043	PFR-R160SS16-L160CS	16	160	72	4.5	2	16	88	15.5	60,200
⑥	7832044	PFR-R200SS20-L180CS	20	180	90	4.5	2	20	90	19.5	88,800
⑦	7832045	PFR-R250SS25-L200CS	25	200	100	4	2	25	100	24.5	116,000
⑧	7832046	PFR-R300SS32-L220CS	30	220	120	4	2	32	100	29.5	157,000
⑨	7832047	PFR-R320SS32-L230CS	32	230	128	4	2	32	102	31.5	165,000

超硬シャンク エキストラロングタイプ Carbide Shank, Extra Long Type

単位:mm Unit:mm

①	ツールNo. EDP No.	呼び Designation	外径 DC	全長 LF	有効長		刃数 ZEPF	シャンク径 DCON	シャンク長 LS	首径 DN	標準価格 (Yen)
					首下長 LH	L/D					
①	7832019	PFR-R060SS06-LL120CS	6	120	42	7	2	6	78	5.4	42,700
②	7832020	PFR-R080SS08-LL140CS	8	140	56	7	2	8	84	7.5	45,000
③	7832021	PFR-R100SS10-LL150CS	10	150	70	7	2	10	80	9.5	45,500
④	7832022	PFR-R120SS12-LL160CS	12	160	84	7	2	12	76	11.5	57,300
⑤	7832023	PFR-R160SS16-LL200CS	16	200	96	6	2	16	104	15.5	63,200
⑥	7832024	PFR-R200SS20-LL240CS	20	240	120	6	2	20	120	19.5	95,500
⑦	7832025	PFR-R250SS25-LL260CS	25	260	137.5	5.5	2	25	122.5	24.5	136,000
⑧	7832026	PFR-R300SS32-LL290CS	30	290	165	5.5	2	32	125	29.5	193,000
⑨	7832027	PFR-R320SS32-LL300CS	32	300	175	5.5	2	32	125	31.5	204,000

■形状寸法表 Specification

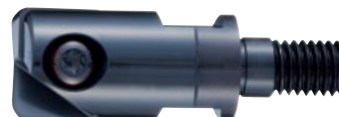
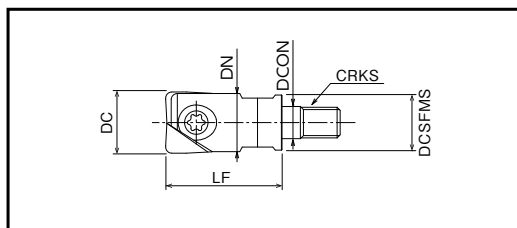

ねじ込みタイプ Screw Fit Type

単位:mm Unit:mm

③	ツールNo. EDP No.	呼び Designation	外径 DC	刃数 ZEFP	取付け径 DCON	ねじサイズ CRKS	スパナサイズ Spanner Size	全長 LF	首径 DN	端面径 DCSFMS	適用シャンク ホルダタイプ Applicable Shank	標準価格 (Yen)
③	7832090	PFR-R100SF6	10	2	6.5	M 6	7	26	9	9	①	18,800
④	7832091	PFR-R120SF6	12	2	6.5	M 6	7	26	11	11	②	19,300
⑤	7832092	PFR-R160SF8	16	2	8.5	M 8	10	32	15	14.5	③	22,400
⑥	7832093	PFR-R200SF10	20	2	10.5	M10	14	38	19	18	④	25,200
⑦	7832094	PFR-R250SF12	25	2	12.5	M12	17	38	24	23	⑤	29,900
⑧	7832095	PFR-R300SF16	30	2	17	M16	22	43	29	28	⑥	39,000
⑨	7832096	PFR-R320SF16	32	2	17	M16	22	43	31	28	⑥	43,300

シャンクホルダについてはp.242 ~ p.244をご覧ください。
See p.242-p.244 for shank holders.

Accessories

■部品 Accessories

	ツールNo. EDP No.	呼び Designation	適用ボディ Applicable Body	推奨締め付けトルク Recommended Tightening Torque
 クランプねじ Clamping Screw	7808124	FS20652RB	①	0.4N・m
	7808123	FS25669RB	②	1N・m
	7808117	FS30686RB	③	1.2N・m
	7808118	FS35610RB	④	2N・m
	7808119	FS40613RB	⑤	3N・m
	7808120	FS50615RB	⑥	5N・m
	7808121	FS60620RB	⑦	5N・m
	7808122	FS80624RB	⑧, ⑨	6N・m

	ツールNo. EDP No.	呼び Designation	適用ボディ Applicable Body	標準価格 (Yen)
 T30-Tのみ T30-T only レンチ Wrench	7808203	T6-D(Torx6)	①	1,050
	7808204	T7-D(Torx7)	②	1,050
	7808205	T8-D(Torx8)	③	1,190
	7808207	T10-D(Torx10)	④	1,190
	7808208	T15-D(Torx15)	⑤	1,260
	7808209	T20-D(Torx20)	⑥, ⑦	1,260
	7808212	T30-T(Torx30)	⑧, ⑨	2,520

レンチは別途ご購入下さい。 The wrenches are sold separately from the cutters.

Phoenix

仕上げ用ラジラスエンドミル

Finishing Radius End Mill

PFRインサート

Inserts

Inserts

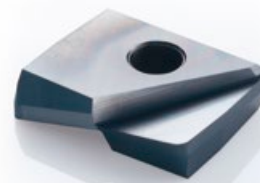
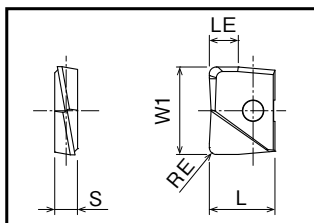

■適用インサート(PFR-ST) Inserts

単位:mm Unit:mm

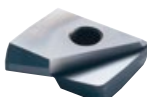
形状 Appearance	呼び Designation	切れ刃数 No. of Cutting Edges	インサート寸法 Insert Size					適用ボディ タイプ Applicable Body	コーティング材種 Grade of Coated Materials	在庫 Stock	標準価格 (Yen)
			W1	コーナ RE	外周 刃長 LE	厚さ S	L		XP3225		
 <p>汎用タイプ Multi-purpose Type</p>	PFR060R03-ST	2	6	0.3	2	2	5	①	7820350	C	5,830
	PFR060R05-ST		6	0.5					7820351	C	5,830
	PFR060R10-ST		6	1					7820352	C	5,830
	PFR070R03-ST		7	0.3					7820353	C	5,960
	PFR070R05-ST		7	0.5					7820354	C	5,960
	PFR070R10-ST		7	1					7820355	C	5,960
	PFR080R03-ST		8	0.3	2.7	2.4	7	②	7820200	C	6,520
	PFR080R05-ST		8	0.5					7820201	C	6,520
	PFR080R10-ST		8	1					7820202	C	6,520
	PFR080R20-ST		8	2					7820203	C	6,520
	PFR100R03-ST		10	0.3	3.3	2.6	8.5	③	7820204	C	6,900
	PFR100R05-ST		10	0.5					7820205	C	6,900
	PFR100R10-ST		10	1					7820206	C	6,900
	PFR100R20-ST		10	2					7820207	C	6,900
	PFR110R03-ST		11	0.3					7820356	C	7,250
	PFR110R05-ST		11	0.5					7820357	C	7,250
	PFR110R10-ST		11	1	7820358	C	7,250				
	PFR110R20-ST		11	2	7820359	C	7,250				
	PFR120R03-ST		12	0.3	4	3	10	④	7820208	C	7,270
	PFR120R05-ST		12	0.5					7820209	C	7,270
	PFR120R10-ST		12	1					7820210	C	7,270
	PFR120R20-ST		12	2					7820211	C	7,270
	PFR120R30-ST		12	3					7820212	C	7,270
	PFR130R03-ST		13	0.3					7820360	C	7,480
	PFR130R05-ST		13	0.5	7820361	C	7,480				
	PFR130R10-ST		13	1	7820362	C	7,480				
	PFR130R20-ST		13	2	7820363	C	7,480				

▶ NEXT

FROM

■適用インサート(PFR-ST) Inserts

単位:mm Unit:mm

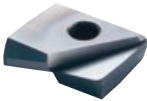
形状 Appearance	呼び Designation	切れ刃数 No. of Cutting Edges	インサート寸法 Insert Size					適用ボディ タイプ Applicable Body	コーティング材種 Grade of Coated Materials	在庫 Stock	標準価格 (Yen)
			W1	コーナ RE	外周 刃長 LE	厚さ S	L		XP3225		
 <p>汎用タイプ Multi-purpose Type</p>	PFR160R03-ST	2	16	0.3	5.3	4	12	⑤	7820213	C	7,520
	PFR160R05-ST		16	0.5					7820214	C	7,520
	PFR160R10-ST		16	1					7820215	C	7,520
	PFR160R20-ST		16	2					7820216	C	7,520
	PFR160R30-ST		16	3					7820217	C	7,520
	PFR170R03-ST		17	0.3					7820364	C	7,890
	PFR170R05-ST		17	0.5					7820365	C	7,890
	PFR170R10-ST		17	1					7820366	C	7,890
	PFR170R20-ST		17	2					7820367	C	7,890
	PFR200R03-ST		20	0.3					6.7	5	15
	PFR200R05-ST		20	0.5	7820219	C	7,890				
	PFR200R10-ST		20	1	7820220	C	7,890				
	PFR200R20-ST		20	2	7820221	C	7,890				
	PFR200R30-ST		20	3	7820222	C	7,890				
	PFR210R03-ST		21	0.3	7820368	C	8,590				
	PFR210R05-ST		21	0.5	7820369	C	8,590				
	PFR210R10-ST		21	1	7820370	C	8,590				
	PFR210R20-ST		21	2	7820371	C	8,590				
	PFR250R03-ST		25	0.3	8.3	6	18.5	⑦			
	PFR250R05-ST		25	0.5					7820224	C	9,260
	PFR250R10-ST		25	1					7820225	C	9,260
	PFR250R20-ST		25	2					7820226	C	9,260
	PFR250R30-ST		25	3					7820227	C	9,260
	PFR260R03-ST		26	0.3					7820372	C	10,100
	PFR260R05-ST		26	0.5					7820373	C	10,100
	PFR260R10-ST		26	1					7820374	C	10,100
	PFR260R20-ST		26	2					7820375	C	10,100
	PFR300R03-ST		30	0.3					10	7	22.5
	PFR300R05-ST		30	0.5	7820229	C	11,000				
	PFR300R10-ST		30	1	7820230	C	11,000				
	PFR300R20-ST		30	2	7820231	C	11,000				
	PFR300R30-ST		30	3	7820232	C	11,000				
PFR320R03-ST	32	0.3	10.3	7	23.5	⑨	7820233	C	11,800		
PFR320R05-ST	32	0.5					7820234	C	11,800		
PFR320R10-ST	32	1					7820235	C	11,800		
PFR320R20-ST	32	2					7820236	C	11,800		
PFR320R30-ST	32	3					7820237	C	11,800		

NEXT

Phoenix

仕上げ用ラジラスエンドミル
Finishing Radius End Mill

PFRインサート

Inserts

Inserts

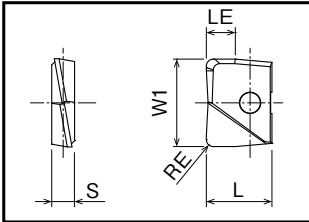

FROM

■適用インサート(PFR-SH) Inserts

単位:mm Unit:mm

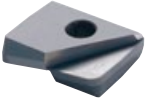
形状 Appearance	呼び Designation	切れ刃数 No. of Cutting Edges	インサート寸法 Insert Size					適用ボディ タイプ Applicable Body	コーティング材種 Grade of Coated Materials	在庫 Stock	標準価格 (Yen)	
			W1	コーナ RE	外周 刃長 LE	厚さ S	L		XP3310			
 <p>刃先強化タイプ Reinforced Edge Type</p>	PFR060R03-SH	2	6	0.3	2	2	5	①	7820400	C	5,830	
	PFR060R05-SH		6	0.5					7820401	C	5,830	
	PFR060R10-SH		6	1					7820402	C	5,830	
	PFR070R03-SH		7	0.3					5.5	7820403	C	5,960
	PFR070R05-SH		7	0.5						7820404	C	5,960
	PFR070R10-SH		7	1						7820405	C	5,960
	PFR080R03-SH		8	0.3	2.7	2.4	7	②	7820250	C	6,520	
	PFR080R05-SH		8	0.5					7820251	C	6,520	
	PFR080R10-SH		8	1					7820252	C	6,520	
	PFR080R20-SH		8	2					7820253	C	6,520	
	PFR100R03-SH		10	0.3	3.3	2.6	8.5	③	7820254	C	6,900	
	PFR100R05-SH		10	0.5					7820255	C	6,900	
	PFR100R10-SH		10	1					7820256	C	6,900	
	PFR100R20-SH		10	2					7820257	C	6,900	
	PFR110R03-SH		11	0.3					7820406	C	7,250	
	PFR110R05-SH		11	0.5					7820407	C	7,250	
	PFR110R10-SH		11	1	7820408	C	7,250					
	PFR110R20-SH		11	2	7820409	C	7,250					
	PFR120R03-SH		12	0.3	4	3	10	④	7820258	C	7,270	
	PFR120R05-SH		12	0.5					7820259	C	7,270	
	PFR120R10-SH		12	1					7820260	C	7,270	
	PFR120R20-SH		12	2					7820261	C	7,270	
	PFR120R30-SH		12	3					7820262	C	7,270	
	PFR130R03-SH		13	0.3					7820410	C	7,480	
PFR130R05-SH	13	0.5	7820411	C	7,480							
PFR130R10-SH	13	1	7820412	C	7,480							
PFR130R20-SH	13	2	7820413	C	7,480							

NEXT

FROM

■適用インサート(PFR-SH) Inserts

単位:mm Unit:mm

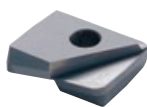
形状 Appearance	呼び Designation	切れ刃数 No. of Cutting Edges	インサート寸法 Insert Size					適用ボディ タイプ Applicable Body	コーティング材種 Grade of Coated Materials	在庫 Stock	標準価格 (Yen)	
			W1	コーナ RE	外周 刃長 LE	厚さ S	L		XP3310			
 <p>刃先強化タイプ Reinforced Edge Type</p>	PFR160R03-SH	2	16	0.3	5.3	4	12	⑤	7820263	C	7,520	
	PFR160R05-SH		16	0.5					7820264	C	7,520	
	PFR160R10-SH		16	1					7820265	C	7,520	
	PFR160R20-SH		16	2					7820266	C	7,520	
	PFR160R30-SH		16	3					7820267	C	7,520	
	PFR170R03-SH		17	0.3					7820414	C	7,890	
	PFR170R05-SH		17	0.5						7820415	C	7,890
	PFR170R10-SH		17	1						7820416	C	7,890
	PFR170R20-SH		17	2						7820417	C	7,890
	PFR200R03-SH		20	0.3	7820268	C	7,890					
	PFR200R05-SH		20	0.5		7820269	C	7,890				
	PFR200R10-SH		20	1		7820270	C	7,890				
	PFR200R20-SH		20	2		7820271	C	7,890				
	PFR200R30-SH		20	3	7820272	C	7,890					
	PFR210R03-SH		21	0.3		7820418	C	8,590				
	PFR210R05-SH		21	0.5			7820419	C	8,590			
	PFR210R10-SH		21	1			7820420	C	8,590			
	PFR210R20-SH		21	2	7820421		C	8,590				
	PFR250R03-SH		25	0.3	7820273	C	9,260					
	PFR250R05-SH		25	0.5		7820274	C	9,260				
	PFR250R10-SH		25	1		7820275	C	9,260				
	PFR250R20-SH		25	2		7820276	C	9,260				
	PFR250R30-SH		25	3	7820277	C	9,260					
	PFR260R03-SH		26	0.3		7820422	C	10,100				
	PFR260R05-SH		26	0.5			7820423	C	10,100			
	PFR260R10-SH		26	1			7820424	C	10,100			
	PFR260R20-SH		26	2	7820425		C	10,100				
	PFR300R03-SH		30	0.3	7820278	C	11,000					
	PFR300R05-SH		30	0.5		7820279	C	11,000				
	PFR300R10-SH		30	1		7820280	C	11,000				
	PFR300R20-SH		30	2			7820281	C	11,000			
	PFR300R30-SH		30	3	7820282	C	11,000					
PFR320R03-SH	32	0.3	7820283	C		11,800						
PFR320R05-SH	32	0.5		7820284		C	11,800					
PFR320R10-SH	32	1		7820285		C	11,800					
PFR320R20-SH	32	2		7820286	C	11,800						
PFR320R30-SH	32	3	7820287	C	11,800							

NEXT

Phoenix

仕上げ用ラジラスエンドミル
Finishing Radius End Mill

PFRインサート

Inserts

Inserts

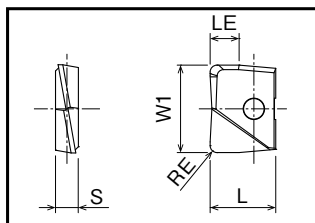

FROM

■適用インサート(PFR-D) Inserts

単位:mm Unit:mm

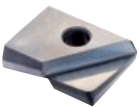
形状 Appearance	呼び Designation	切れ刃数 No. of Cutting Edges	インサート寸法 Insert Size					適用ボディ タイプ Applicable Body	コーティング材種 Grade of Coated Materials	在庫 Stock	標準価格 (Yen)
			W1	コーナ RE	外周 刃長 LE	厚さ S	L		XC4505		
 ダイヤモンド コーティング Diamond Coated	PFR060R03-D	2	6	0.3	2	2	5	①	7820450	C	16,300
	PFR060R05-D		6	0.5					7820451	C	16,300
	PFR060R10-D		6	1					7820452	C	16,300
	PFR080R03-D		8	0.3	2.7	2.4	7	②	7820300	C	17,000
	PFR080R05-D		8	0.5					7820301	C	17,000
	PFR080R10-D		8	1					7820302	C	17,000
	PFR080R20-D		8	2						※	
	PFR100R03-D		10	0.3	3.3	2.6	8.5	③	7820303	C	18,700
	PFR100R05-D		10	0.5					7820304	C	18,700
	PFR100R10-D		10	1					7820305	C	18,700
	PFR100R20-D		10	2		※					
	PFR120R03-D		12	0.3	4	3	10	④	7820306	C	20,300
	PFR120R05-D		12	0.5					7820307	C	20,300
	PFR120R10-D		12	1					7820308	C	20,300
	PFR120R20-D		12	2						※	
	PFR120R30-D		12	3		※					
	PFR160R03-D		16	0.3	5.3	4	12	⑤	7820309	C	22,200
	PFR160R05-D		16	0.5					7820310	C	22,200
	PFR160R10-D		16	1					7820311	C	22,200
	PFR160R20-D		16	2						※	
	PFR160R30-D		16	3		※					
	PFR200R03-D		20	0.3	6.7	5	15	⑥	7820312	C	23,600
	PFR200R05-D		20	0.5					7820313	C	23,600
	PFR200R10-D		20	1					7820314	C	23,600
	PFR200R20-D		20	2						※	
	PFR200R30-D		20	3						※	
	PFR250R10-D		25	1	8.3	6	18.5	⑦		※	
	PFR300R10-D		30	1	10	7	22.5	⑧		※	
PFR320R10-D	32	1	10.3	7	23.5	⑨		※			

Cutting Conditions

被削材別推奨材質

Recommended Materials by Insert Type

◎第一推奨材質 Best
○第二推奨材質 Good

インサート材種 Insert Grades	形状 Appearance	P	M	K	N	S	H
XP3225	PFR-ST	◎	◎	○	◎*1	◎	○
XP3310	PFR-SH	○	○	◎			◎
XC4505	PFR-D				◎*2		

* L/D ≥ 5 以上にはXP3225を第一推奨します XP3225 is recommended when L/D ≥ 5
 * 断続切削にはXP3310を第一推奨します XP3310 is recommended for intermittent milling
 *1 アルミニウム合金の第一推奨 Best recommended for aluminum alloy
 *2 グラファイト、CFRPの第一推奨 Best recommended for graphite and CFRP applications

切削条件基準表 Cutting Conditions

標準条件 Standard Condition

PFR-ST, PFR-SH

	被削材 Work Material	引張強さ・硬さ Tensile Strength Hardness	切削速度 V_c (m/min) Cutting Speed			切込深さの 目安 a_p (mm) Depth of Cut	1刃当たりの送り f_z (mm/t)					
			突出し量 %				インサートW1 Insert					
			基準2.5D	5D	8D		$\phi 6, 7$	$\phi 8 \sim 11$	$\phi 12 \sim 17$	$\phi 20 \sim 32$		
P	軟鋼、低炭素鋼 (SS400, S10C) Mild Steel, Carbon Steel	~180HB	200 (150 ~ 250)			80%	60%	0.05DC	0.12	0.2	0.22	0.25
	炭素鋼、合金鋼 (S50C, SCM440) Carbon Steel, Alloy Steel	~280HB	180 (150 ~ 250)					0.05DC	0.15	0.18	0.22	0.25
	ダイス鋼 (SKD61, SKD11) Die Steel	~280HB	150 (120 ~ 200)					0.05DC	0.1	0.15	0.18	0.2
M	ステンレス鋼 (SUS304, SUS420) Stainless Steel	~250HB	150 (100 ~ 200)					0.03DC	0.08	0.12	0.15	0.18
K	鋳鉄 (FC250) Cast Iron	~300N/mm ²	200 (150 ~ 250)					0.05DC	0.15	0.2	0.25	0.3
	ダクタイル鋳鉄 (FCD400) Ductile Cast Iron	~600N/mm ²	150 (100 ~ 200)					0.05DC	0.12	0.15	0.2	0.25
N	アルミニウム合金 Aluminum Alloy	~13%Si	300 (200 ~ 400)					0.05DC	0.2	0.25	0.3	0.35
S	超耐熱合金(湿式) (Inconel 718) Superalloy (Wet)	-	30 (20 ~ 40)					0.02DC	0.04	0.05	0.08	0.12
	チタン合金(湿式) (Ti-6Al-4V) Titanium Alloy (Wet)	-	50 (40 ~ 60)					0.02DC	0.05	0.08	0.1	0.15
H	プリハードン鋼 (NAK80, STAVAX) Pre-hardened Steel	40 ~ 43HRC	120 (100 ~ 150)					0.03DC	0.08	0.1	0.12	0.18
	ダイカスト鋼 (DAC-MAGIC, DH31) Die Cast Steel	43 ~ 48HRC	80 (50 ~ 100)			0.025DC	0.05	0.08	0.1	0.15		
	調質鋼 (SKD11) Hardened Steel	50 ~ 60HRC	60 (40 ~ 80)			0.02DC	0.04	0.05	0.08	0.1		

PFR-D

	被削材 Work Material	切削速度 V_c (m/min) Cutting Speed			切込深さの 目安 a_p (mm) Depth of Cut	1刃当たりの送り f_z (mm/t)			
		突出し量 %				インサートW1 Insert			
		基準2.5D	5D	8D		$\phi 6, 7$	$\phi 8 \sim 11$	$\phi 12 \sim 17$	$\phi 20 \sim 32$
N	グラファイト Graphite	250 (150 ~ 350)	80%	60%	0.1DC	0.25	0.4	0.5	0.5
	複合材 Carbon Fiber Reinforced Plastic (CFRP)	200 (150 ~ 250)			0.5DC	0.05	0.1	0.15	0.2

上記の数値は実切削速度における一般的な値を示したものです。加工環境に合わせて適宜調整して下さい。
 The above cutting conditions are to be used as general guidelines. Adjustments may be necessary depending on actual cutting conditions.

Cutting Conditions

■切削条件基準表 Cutting Conditions

高速仕上げ条件 High-speed finishing conditions

鋼シャンク Steel Shank

	被削材 Work Material	引張強さ・硬さ Tensile Strength・Hardness	切削速度 Vc (m/min) Cutting Speed	切込深さ ap (mm) Depth of Cut	1刃当たりの送り fz (mm/t)			
					インサートW1 Insert			
					φ6 ~ 8	φ10 ~ 13	φ16 ~ 21	φ25 ~ 32
P	軟鋼、低炭素鋼 Mild Steel, Carbon Steel (SS400, S10C)	~180HB	450	0.02DC	0.1	0.12	0.14	0.18
	炭素鋼、合金鋼 Carbon Steel, Alloy Steel (S50C, SCM440)	~280HB	450	0.02DC	0.07	0.1	0.12	0.14
	ダイス鋼 Die Steel (SKD61, SKD11)	~280HB	375	0.02DC	0.07	0.1	0.12	0.14
M	ステンレス鋼 Stainless Steel (SUS304, SUS420)	~250HB	375	0.02DC	0.07	0.12	0.14	0.17
K	鑄鉄 Cast Iron (FC250)	~300N/mm ²	600	0.02DC	0.12	0.14	0.18	0.22
	ダクタイル鑄鉄 Ductile Cast Iron (FCD400)	~600N/mm ²	450	0.02DC	0.1	0.12	0.14	0.18
N	アルミニウム合金 Aluminum Alloy	~13%Si	750	0.03DC	0.12	0.14	0.18	0.22
S	超耐熱合金(湿式) Superalloy (Wet) (Inconel 718)	-	70	0.015DC	0.04	0.05	0.06	0.06
	チタン合金(湿式) Titanium Alloy (Wet) (Ti-6Al-4V)	-	120	0.02DC	0.06	0.08	0.11	0.13
H	プリハードン鋼 Pre-hardened Steel (NAK80, STAVAX)	40 ~ 43HRC	300	0.015DC	0.06	0.07	0.08	0.1
	ダイカスト鋼 Die Cast Steel (DAC-MAGIC, DH31)	43 ~ 48HRC	270	0.015DC	0.05	0.06	0.07	0.07
	調質鋼 Hardened Steel (SKD11)	50 ~ 60HRC	220	0.01DC	0.05	0.06	0.07	0.07

超硬シャンク ショートタイプ Carbide Shank Short Type

	被削材 Work Material	引張強さ・硬さ Tensile Strength・Hardness	切削速度 Vc (m/min) Cutting Speed	切込深さ ap (mm) Depth of Cut	1刃当たりの送り fz (mm/t)			
					インサートW1 Insert			
					φ6 ~ 8	φ10 ~ 13	φ16 ~ 21	φ25 ~ 32
P	軟鋼、低炭素鋼 Mild Steel, Carbon Steel (SS400, S10C)	~180HB	540	0.02DC	0.1	0.12	0.14	0.18
	炭素鋼、合金鋼 Carbon Steel, Alloy Steel (S50C, SCM440)	~280HB	540	0.02DC	0.07	0.1	0.12	0.14
	ダイス鋼 Die Steel (SKD61, SKD11)	~280HB	450	0.02DC	0.07	0.1	0.12	0.14
M	ステンレス鋼 Stainless Steel (SUS304, SUS420)	~250HB	450	0.02DC	0.07	0.12	0.14	0.17
K	鑄鉄 Cast Iron (FC250)	~300N/mm ²	720	0.02DC	0.12	0.14	0.18	0.22
	ダクタイル鑄鉄 Ductile Cast Iron (FCD400)	~600N/mm ²	540	0.02DC	0.1	0.12	0.14	0.18
N	アルミニウム合金 Aluminum Alloy	~13%Si	600	0.03DC	0.12	0.14	0.18	0.22
S	超耐熱合金(湿式) Superalloy (Wet) (Inconel 718)	-	80	0.015DC	0.04	0.05	0.06	0.06
	チタン合金(湿式) Titanium Alloy (Wet) (Ti-6Al-4V)	-	150	0.02DC	0.06	0.08	0.11	0.13
H	プリハードン鋼 Pre-hardened Steel (NAK80, STAVAX)	40 ~ 43HRC	340	0.015DC	0.06	0.07	0.08	0.1
	ダイカスト鋼 Die Cast Steel (DAC-MAGIC, DH31)	43 ~ 48HRC	290	0.015DC	0.05	0.06	0.07	0.07
	調質鋼 Hardened Steel (SKD11)	50 ~ 60HRC	260	0.01DC	0.05	0.06	0.07	0.07

・上記の数値は実切削速度における一般的な値を示したものです。加工環境に合わせて適宜調整して下さい。
The above cutting conditions are to be used as general guidelines. Adjustments may be necessary depending on actual cutting conditions.

■ 切削条件基準表 Cutting Conditions

高速仕上げ条件 High-speed finishing conditions

超硬ロングシャンク Carbide Shank Long Type

	被削材 Work Material	引張強さ・硬さ Tensile Strength・Hardness	切削速度 Vc (m/min) Cutting Speed	切込深さ ap (mm) Depth of Cut	1刃当たりの送り fz (mm/t)			
					インサートW1 Insert			
					φ6~8	φ10~13	φ16~21	φ25~32
P	軟鋼、低炭素鋼 Mild Steel, Carbon Steel (SS400, S10C)	~180HB	480	0.02DC	0.1	0.12	0.14	0.18
	炭素鋼、合金鋼 Carbon Steel, Alloy Steel (S50C, SCM440)	~280HB	480	0.02DC	0.07	0.1	0.12	0.14
	ダイス鋼 Die Steel (SKD61, SKD11)	~280HB	400	0.02DC	0.07	0.1	0.12	0.14
M	ステンレス鋼 Stainless Steel (SUS304, SUS420)	~250HB	400	0.02DC	0.07	0.12	0.14	0.17
K	鋳鉄 Cast Iron (FC250)	~300N/mm ²	640	0.02DC	0.12	0.14	0.18	0.22
	ダクタイル鋳鉄 Ductile Cast Iron (FCD400)	~600N/mm ²	480	0.02DC	0.1	0.12	0.14	0.18
N	アルミニウム合金 Aluminum Alloy	~13%Si	800	0.03DC	0.12	0.14	0.18	0.22
S	超耐熱合金(湿式) Superalloy (Wet) (Inconel 718)	-	80	0.015DC	0.04	0.05	0.06	0.06
	チタン合金(湿式) Titanium Alloy (Wet) (Ti-6Al-4V)	-	144	0.02DC	0.06	0.08	0.11	0.13
H	プリハードン鋼 Pre-hardened Steel (NAK80, STAVAX)	40~43HRC	320	0.015DC	0.06	0.07	0.08	0.1
	ダイカスト鋼 Die Cast Steel (DAC-MAGIC, DH31)	43~48HRC	288	0.015DC	0.05	0.06	0.07	0.07
	調質鋼 Hardened Steel (SKD11)	50~60HRC	240	0.01DC	0.05	0.06	0.07	0.07

超硬シャンク エキストラロングタイプ Carbide Shank Extra Long Type

	被削材 Work Material	引張強さ・硬さ Tensile Strength・Hardness	切削速度 Vc (m/min) Cutting Speed	切込深さ ap (mm) Depth of Cut	1刃当たりの送り fz (mm/t)			
					インサートW1 Insert			
					φ6~8	φ10~13	φ16~21	φ25~32
P	軟鋼、低炭素鋼 Mild Steel, Carbon Steel (SS400, S10C)	~180HB	360	0.02DC	0.1	0.12	0.14	0.18
	炭素鋼、合金鋼 Carbon Steel, Alloy Steel (S50C, SCM440)	~280HB	360	0.02DC	0.07	0.1	0.12	0.14
	ダイス鋼 Die Steel (SKD61, SKD11)	~280HB	300	0.02DC	0.07	0.1	0.12	0.14
M	ステンレス鋼 Stainless Steel (SUS304, SUS420)	~250HB	300	0.02DC	0.07	0.12	0.14	0.17
K	鋳鉄 Cast Iron (FC250)	~300N/mm ²	480	0.02DC	0.12	0.14	0.18	0.22
	ダクタイル鋳鉄 Ductile Cast Iron (FCD400)	~600N/mm ²	360	0.02DC	0.1	0.12	0.14	0.18
N	アルミニウム合金 Aluminum Alloy	~13%Si	600	0.03DC	0.12	0.14	0.18	0.22
S	超耐熱合金(湿式) Superalloy (Wet) (Inconel 718)	-	60	0.015DC	0.04	0.05	0.06	0.06
	チタン合金(湿式) Titanium Alloy (Wet) (Ti-6Al-4V)	-	110	0.02DC	0.06	0.08	0.11	0.13
H	プリハードン鋼 Pre-hardened Steel (NAK80, STAVAX)	40~43HRC	240	0.015DC	0.06	0.07	0.08	0.1
	ダイカスト鋼 Die Cast Steel (DAC-MAGIC, DH31)	43~48HRC	220	0.015DC	0.05	0.06	0.07	0.07
	調質鋼 Hardened Steel (SKD11)	50~60HRC	180	0.01DC	0.05	0.06	0.07	0.07

・上記の数値は実切削速度における一般的な値を示したものです。加工環境に合わせて適宜調整して下さい。
The above cutting conditions are to be used as general guidelines. Adjustments may be necessary depending on actual cutting conditions.

Cutting Data

加工事例 Cutting Data

PX5(プラスチック金型用鋼 33HRC)の側面、底面仕上げ Side and bottom finish for PX5 (plastic mold steel 33HRC)

使用工具 Tool	PFR-R250SS25-LL260CS
使用インサート(材種) Insert (grade)	PFR250R20-ST (XP3225)
被削材 Work Material	PX5 (33HRC)
切削速度 Cutting Speed	82m/min (1,050min ⁻¹)
送り速度 Feed	500mm/min (0.24mm/t)
切込深さ Depth of Cut	a _p =0.5mm a _e =0.5~1mm
切削油剤 Coolant	水溶性切削油剤 Water-Soluble
使用機械 Machine	横形マシニングセンタ(BT50) Horizontal Machining Center

インデキサブルでありながらソリッド工具並みの高精度加工ができた。既存の工具よりも切れ味が良く、切込み量を上げて安定した加工ができたため、中仕上げ工程を削減することにより加工時間の短縮ができた。

PFR enabled high precision machining as well as solid carbide tool. With the sharper cutting edge than conventional tools, PFR could be operated stably with deeper depth of cut. As a result, machining time was shortened by reducing semi-finishing process.

ユーザ事例 Field Data

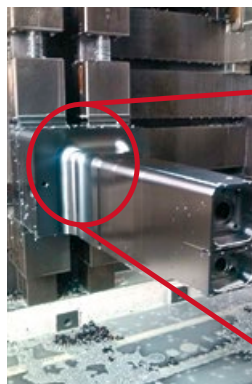

加工ワーク 金型入れ子
Machined workpiece: die insert



1ワーク88m(3時間)加工後の刃先の損傷状態
Cutting edge after 88m (3 hours) of milling



すくい面 Rake



逃げ面 Flank

プラスチック金型用鋼の側面、底面仕上げ Side and bottom finish for plastic mold steel

使用工具 Tool	PFB-R200SS20-LL240CS (PFBボディを代用) (substituting PFB Body)	
使用インサート(材種) Insert (grade)	PFR200R10-ST (XP3225)	
被削材 Work Material	SD18(S55C 改良材) (enhanced S55C)	
切削速度 Cutting Speed	側面仕上げ部 Side finish section 330m/min (5,250min ⁻¹)	底面仕上げ部 Bottom finish section 100m/min (1,600min ⁻¹)
送り速度 Feed	2,100mm/min (0.2mm/t)	400mm/min (0.125mm/t)
切込深さ Depth of Cut	a _p =1.5mm a _e =0.05~0.3mm	中仕上げ Semi-finish a _p =0.15mm 最終仕上げ Final finish a _p =0.05mm
切削油剤 Coolant	なし(エアブロー) Air Blow	
使用機械 Machine	立形マシニングセンタ(HSK A100) Vertical Machining Center	

従来は中仕上げ、最終仕上げに各1個のチップを使用していたが、PFRは耐久性が良く1個で最終仕上げまで加工することができた。さらに加工面精度も向上した。

With the conventional tool, one insert for semi-finishing and another insert for finishing were consumed. With PFR, one insert could be last until the final finishing process. Furthermore, better finished surface was achieved.

ユーザ事例 Field Data

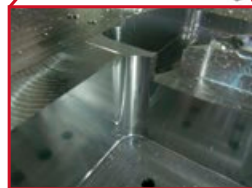
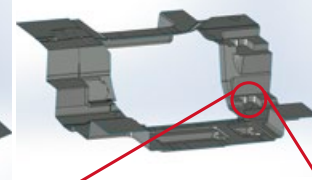
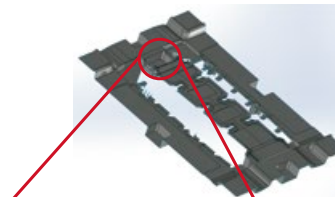

トータル(90分)加工後の刃先の損傷状態
Cutting edge after 90 minutes of milling

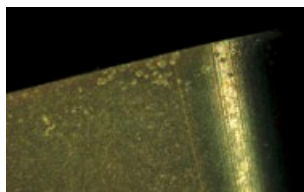

突出しが長くても欠損は無く、正常摩耗であった。

The cutting edge shows normal wear, and there is no chipping despite the long overhang length.

FCD600における耐久性能評価試験 Durability performance evaluation test with FCD600

使用工具 Tool	PFR-R200SS20-S160
使用インサート(材種) Insert (grade)	PFR200R10-SH (XP3310)
被削材 Work Material	FCD600
切削速度 Cutting Speed	200m/min (3,200min ⁻¹)
送り速度 Feed	1,280mm/min (0.2mm/t)
切込深さ Depth of Cut	a _p =1mm a _e =2mm
切削油剤 Coolant	なし(エアブロー) Air Blow
使用機械 Machine	横形マシニングセンタ(BT40) Horizontal Machining Center

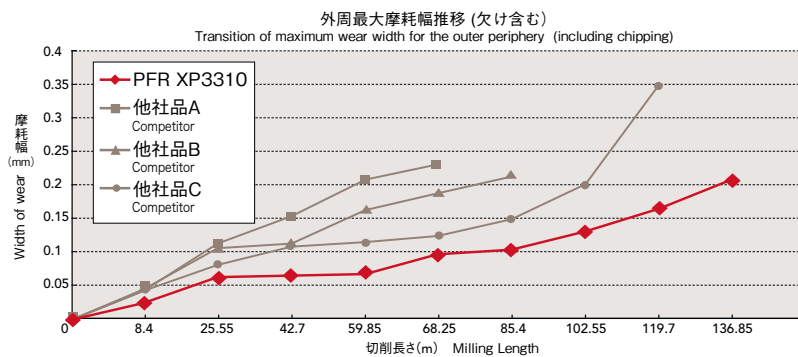

PFRは切削初期から摩耗の進行が遅く、安定した加工が可能であった。

PFR enabled stable machining, and the wear progress had been slow since the early stage.

DH31 (熱間金型用鋼 48HRC) における耐久性能評価試験 Durability performance evaluation test with DH31 (hot-die steel 48HRC)

使用工具 Tool	PFR-R200SS20-S160
使用インサート(材種) Insert (grade)	PFR200R10-SH (XP3310)
被削材 Work Material	DH31 (48HRC)
切削速度 Cutting Speed	60m/min (955min ⁻¹)
送り速度 Feed	191mm/min (0.1mm/t)
切込深さ Depth of Cut	a _p =0.5mm a _e =1mm
切削油剤 Coolant	水溶性切削油剤 Water-Soluble
使用機械 Machine	横形マシニングセンタ(BT40) Horizontal Machining Center

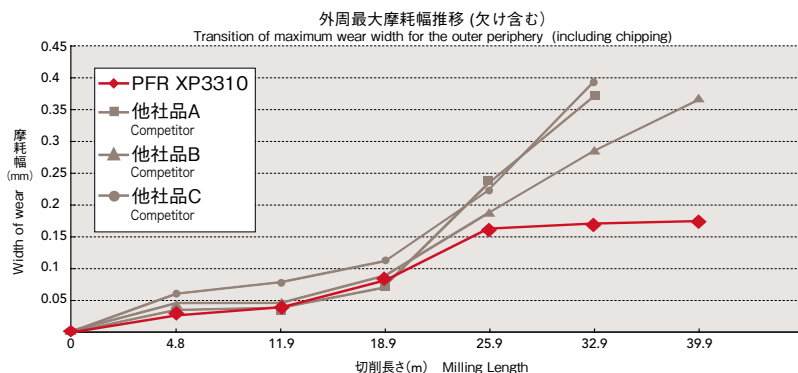

32.9m 加工時の損傷状態 State of damage after 32.9m of machining

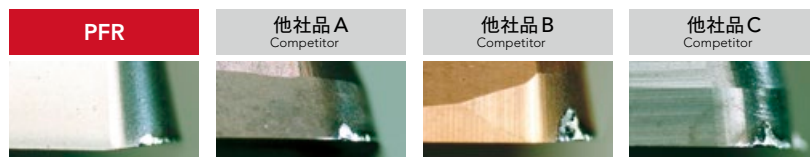

PFR(XP3310)は刃先に施されたチャンファの効果により耐欠損性が高く、熱間工具鋼(48HRC)に対しても安定した加工が可能であった。

With the special chamfer on the cutting edge, PFR's insert XP3310 have a high chipping resistance. It enabled stable operation in machining hot work tool steel.

Cutting Data

■加工事例 Cutting Data

S50Cにおける耐久性能評価試験 Durability performance evaluation test with S50C

使用工具 Tool	PFR-R200SS20-S160
使用インサート(材種) Insert (grade)	PFR200R10-ST (XP3225)
被削材 Work Material	S50C
切削速度 Cutting Speed	200m/min (3,200min ⁻¹)
送り速度 Feed	1,280mm/min (0.2mm/t)
切込深さ Depth of Cut	a _p =0.1mm a _e =2mm
切削油剤 Coolant	水溶性切削油剤 Water-Soluble
使用機械 Machine	横形マシニングセンター(BT40) Horizontal Machining Center

他社品はいずれも切削距離43mを超えると大きく摩耗が進行した。PFR(XP3225)は140m加工時点でも摩耗量は小さく、継続使用可能であった。

Competitors' products showed significant wear when exceeding 43m of milling length. PFR's insert XP3225, however, showed only little wear even after 140m length and remained good.

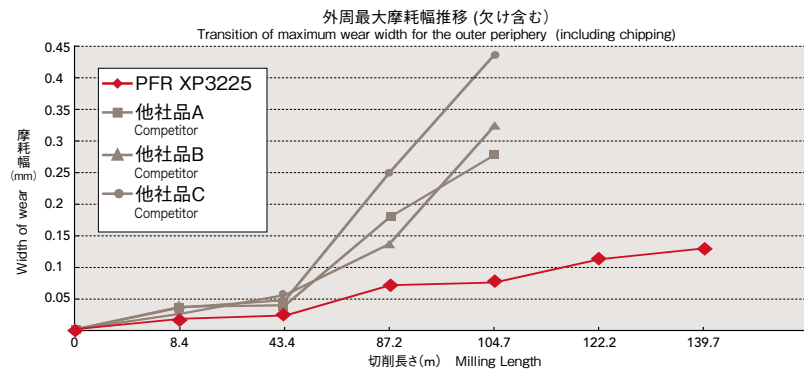

104.7m加工時の損傷状態 State of damage after 104.7m of machining

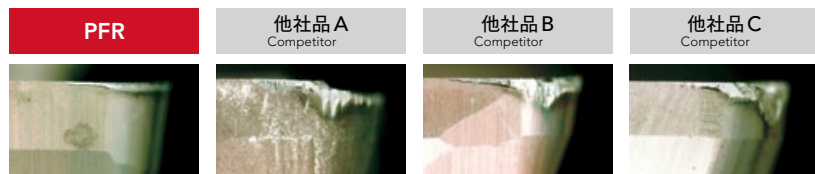

PFR-Dによるグラファイト電極加工 フィールド試験 Field data of machining graphite electrode with PFR-D

使用工具 Tool	PFR-R200SS20-S160CS
使用インサート(材種) Insert (grade)	PFR200R20-D [R2特殊] (XC4505) Special
被削材 Work Material	グラファイト Graphite
切削速度 Cutting Speed	125m/min (2,000min ⁻¹)
送り速度 Feed	1,000mm/min (0.25mm/t)
加工方法 Cutting Method	等高線加工 Contour Milling
切込深さ Depth of Cut	a _p =1mm a _e =0.5mm
切削油剤 Coolant	なし None
使用機械 Machine	立形グラファイト加工機(BT40) Vertical Graphite Milling Machine

	外周刃 Peripheral Cutting Edge	底刃 End Teeth	すくい面 Rake Angle
17時間加工後の刃先損傷状態 State of damage after 17 hours of machining			
逃げ面摩耗量 Frank wear	0.049mm	0.021mm	



他社超硬ソリッドエンドミルに対し、同等の加工面精度が得られた。インデキサル化することによりコスト削減に繋がった。

PFR-B achieved fair finishing surface accuracy versus the competition. Also machining cost was reduced by applying PFB instead of using solid carbide end mills.



PFR-Dによるグラファイト電極加工 フィールド試験 Field data of machining graphite electrode with PFR-D

使用工具 Tool	PFR-R160SS-S140CS
使用インサート(材種) Insert (grade)	PFR160R10-D (XC4505)
被削材 Work Material	グラファイト Graphite
工具突出し量 Overhang Length	50mm (2.5D)
切削速度 Cutting Speed	135m/min (2,700min ⁻¹)
送り速度 Feed	3,330mm/min (0.62mm/t)
加工方法 Cutting Method	等高線加工 Contour Milling
切込深さ Depth of Cut	ap=0.22~0.5mm ae=2~8mm
切削油剤 Coolant	なし None
使用機械 Machine	立形マシニングセンタ(BT40) Vertical Machining Center

	外周刃 Peripheral Cutting Edge	底刃 End Teeth	すくい面 Rake Angle
10時間加工後の 刃先損傷状態 State of damage after 10 hours of machining			
逃げ面摩耗量 Frank wear	0.062mm	0.087mm	

試験終了後(10時間)、刃先には異常な剥離もなく、良好な摩耗状態であった。他社ダイヤモンドボールエンドミルに対し、大幅な加工時間の短縮ができた。

After finish machining of 10 hours, cutting edge was in good shape with normal wear. No abnormal peel off of coating was found. By applying PFR-D, machining time was drastically reduced versus the competitor's diamond coated ball end mill.

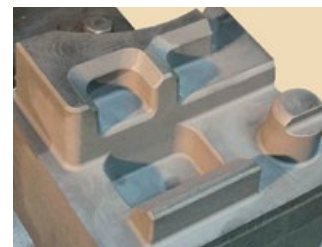

テストピース形状
Shape of Test Piece

Phoenix SF

ねじ込みタイプ
Screw Fit Type

Screw Fit

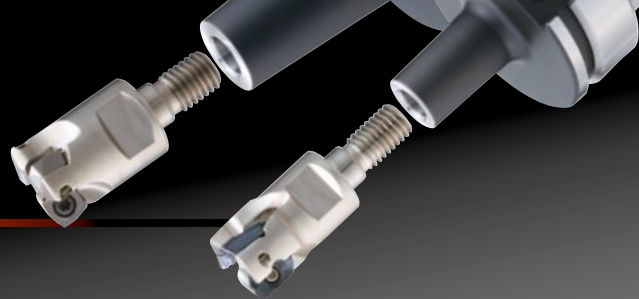

Specification

■形状寸法表 Specification

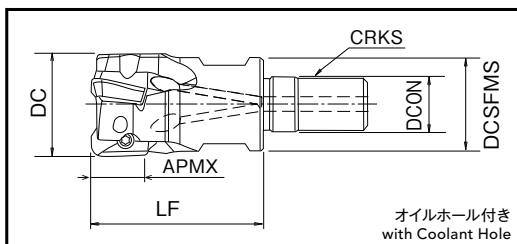

PSE ねじ込みタイプ Screw Fit Type

単位:mm Unit:mm

ツールNo. EDP No.	呼び Designation	外径 DC	刃数 ZEPF	取付け径 DCON	ねじサイズ CRKS	スパナサイズ Spanner Size	全長 LF	端面径 DCSFMS	APMX	重量 (kg)	適用インサート Applicable Inserts	適用シャンク ホルダタイプ Applicable Shank	標準価格 (Yen)
NEW 7803822	PSE07R010SF6-2	10	2	6.5	M 6	7	26	9	6	0.011	①	①	29,400
NEW 7803823	PSE07R012SF6-3	12	3	6.5	M 6	7	26	11	6	0.01		②	36,400
NEW 7803824	PSE07R016SF8-4	16	4	8.5	M 8	10	27	15	6	0.032		③	40,100
NEW 7803825	PSE07R020SF10-4	20	4	10.5	M 10	14	33	18	6	0.063		④	44,900
NEW 7803826	PSE07R025SF12-5	25	5	12.5	M 12	17	35	23	6	0.111		⑤	52,500
NEW 7803827	PSE07R032SF16-6	32	6	17	M 16	22	35	28	6	0.176		⑥	57,700
7801600	PSE11R016SF8-2	16	2	8.5	M 8	10	27	14.5	10	0.03	②	③	46,600
7801612	PSE11R017SF8-2	★17	2	8.5	M 8	10	27	14.5	10	0.03			46,600
7801613	PSE11R018SF8-2	★18	2	8.5	M 8	10	27	14.5	10	0.03			46,600
7801601	PSE11R020SF10-3	20	3	10.5	M 10	14	33	18	10	0.06		④	63,100
7801614	PSE11R021SF10-3	★21	3	10.5	M 10	14	33	18	10	0.06			63,100
7801615	PSE11R022SF10-3	★22	3	10.5	M 10	14	33	18	10	0.06			63,100
7801602	PSE11R025SF12-4	25	4	12.5	M 12	17	35	23	10	0.1		⑤	77,000
7801616	PSE11R026SF12-3	★26	3	12.5	M 12	17	35	23	10	0.1			77,000
7801603	PSE11R028SF12-4	★28	4	12.5	M 12	17	35	23	10	0.11			77,000
7801604	PSE11R032SF16-5	32	5	17	M 16	22	40	28	10	0.19		⑥	94,400
7801617	PSE11R033SF16-3	★33	3	17	M 16	22	40	28	10	0.2			94,400
7801605	PSE11R035SF16-5	★35	5	17	M 16	22	40	28	10	0.2			94,400
7801606	PSE11R040SF16-6	40	6	17	M 16	22	40	28	10	0.22	103,000		
7801607	PSE15R025SF12-2	25	2	12.5	M 12	17	35	23	14	0.09	③		56,100
7801618	PSE15R026SF12-2	★26	2	12.5	M 12	17	35	23	14	0.1		56,100	
7801608	PSE15R028SF12-2	★28	2	12.5	M 12	17	35	23	14	0.1		56,100	
7801609	PSE15R032SF16-3	32	3	17	M 16	22	40	28	14	0.17		77,000	
7801619	PSE15R033SF16-3	★33	3	17	M 16	22	40	28	14	0.18		77,000	
7801610	PSE15R035SF16-3	★35	3	17	M 16	22	40	28	14	0.18		77,000	
7801611	PSE15R040SF16-4	40	4	17	M 16	22	40	28	14	0.2		88,200	

★ PSE 刃太タイプ Reduced Shank Type

・刃太タイプは、シャンク径よりも工具外径の方が大きいいため、金型部品などの深い立ち壁加工やポケット加工に最適です

・The outer diameter of the reduced shank type is larger than the shank diameter, making it highly effective in the processing of die and mold applications that require vertical wall milling or pocketing.

例
Example

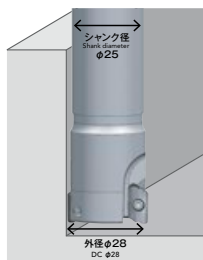

インサート及び部品はp.110～p.116をご覧ください。
See p.110-p.116 for inserts and accessories.
シャンクホルダについてはp.242～p.244をご覧ください。
See p.242-p.244 for shank holders.

★ 刃太タイプ
Reduced Shank Type

Specification

■形状寸法表 Specification

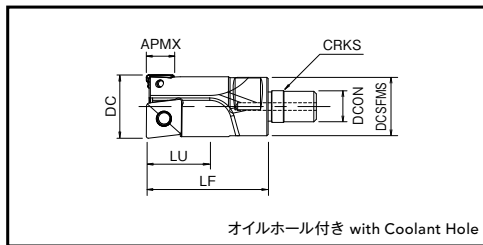

PMD ねじ込みタイプ Screw Fit Type

単位:mm Unit:mm

ツールNo. EDP No.	呼び Designation	外径 DC	溝数 NOF	刃数 ZEPF	取付け 径 DCON	ねじ サイズ CRKS	スパナ サイズ Spanner Size	全長 LF	首径 DN	有効 溝長 LU	刃長 APMX	端面径 DCSPMS	重量 (kg)	適用インサート Applicable Inserts		適用シャンク ホルダタイプ Applicable Shank	標準価格 (Yen)		
														底刃 Center Insert	外周刃 Peripheral Insert				
NEW 7803423	PMD07R016SF8-1	16			8.5	M 8	10	40	15.4	16	6	14.5	0.07	① ZPNT080304EN	① ZDKT070304...	③	25,100		
NEW 7803424	PMD07R018SF8-1	★18			8.5	M 8	10	40	17	18		14.5	0.08	② ZPNT090404EN					25,900
NEW 7803416	PMD11R020SF10-1	20	2	1	10.5	M10	14	48	19	20	10	18	0.1	③ ZPNT100408EN	② ZDKT11T308...	④	27,500		
NEW 7803417	PMD11R025SF12-1	25			12.5	M12	17	48	23	25		23	0.15	④ ZPNT130508EN				⑤	30,200
NEW 7803418	PMD11R032SF16-1	32			17	M16	22	58	30	28		28	0.3	⑤ ZPNT170608EN				⑥	32,900

インサート及び部品はp.149～p.151をご覧ください。

See p.149-p.151 for inserts and accessories.

シャンクホルダについてはp.242～p.244をご覧ください。

See p.242-p.244 for shank holders.

★刃太タイプ

Reduced Shank Type

★ PMD 刃太タイプ Reduced Shank Type

例
Example

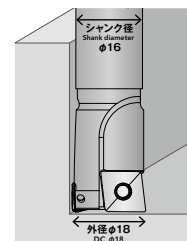

・刃太タイプは、シャンク径よりも工具外径の方が大きいので、金型部品などの深い立ち壁加工やポケット加工に最適です

・The outer diameter of the reduced shank type is larger than the shank diameter, making it highly effective in the processing of die and mold applications that require vertical wall milling or pocketing.

Phoenix

ねじ込みタイプ

Screw Fit Type

SF

■形状寸法表 Specification

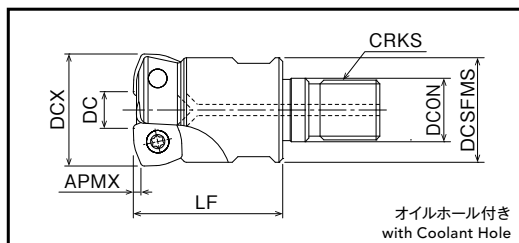

オイルホール付き
with Coolant Hole



PHC ねじ込みタイプ Screw Fit Type

単位:mm Unit:mm

ツールNo. EDP No.	呼び Designation	カッタ外径 DCX	外径 DC	刃数 ZEPF	取付け径 DCON	ねじサイズ CRKS	スパナサイズ Spanner Size	全長 LF	端面径 DCSFMS	APMX	重量 (kg)	適用インサート Applicable Inserts	適用シャンク ホルダタイプ Applicable Shank	標準価格 (Yen)
7801520	PHC07R016SF8-2	16	7.4	2	8.5	M 8	10	27	14.5	0.8	0.03	①	③	33,600
7801521	PHC07R017SF8-2	★ 17	8.4	2	8.5	M 8	10	27	14.5	0.8	0.03			33,600
7801522	PHC07R018SF8-2	★ 18	9.4	2	8.5	M 8	10	27	14.5	0.8	0.03			33,600
7801523	PHC07R020SF10-3	20	11.4	3	10.5	M10	14	33	18	0.8	0.06			46,800
7801524	PHC07R021SF10-3	★ 21	12.4	3	10.5	M10	14	33	18	0.8	0.06			46,800
7801525	PHC07R022SF10-3	★ 22	13.4	3	10.5	M10	14	33	18	0.8	0.06			46,800
7801526	PHC07R025SF12-4	25	16.4	4	12.5	M12	17	35	23	0.8	0.1			59,400
7801527	PHC07R026SF12-4	★ 26	17.4	4	12.5	M12	17	35	23	0.8	0.1			59,400
7801528	PHC07R028SF12-4	★ 28	19.4	4	12.5	M12	17	35	23	0.8	0.11			59,400
7801529	PHC07R030SF16-4	30	21.4	4	17	M16	22	40	28	0.8	0.2			67,500
7801530	PHC07R032SF16-5	32	23.4	5	17	M16	22	40	28	0.8	0.18			74,300
7801531	PHC07R033SF16-5	★ 33	24.4	5	17	M16	22	40	28	0.8	0.18			74,300
7801532	PHC07R035SF16-5	★ 35	26.4	5	17	M16	22	40	28	0.8	0.2	74,300		
7801500	PHC09R025SF12-3	25	13.2	3	12.5	M12	17	35	23	1	0.1	②	⑤	75,400
7801510	PHC09R026SF12-3	★ 26	14.2	3	12.5	M12	17	35	23	1	0.11			75,400
7801501	PHC09R028SF12-3	★ 28	16.2	3	12.5	M12	17	35	23	1	0.11			75,400
7801502	PHC09R030SF16-3	30	18.2	3	17	M16	22	40	28	1	0.17			82,700
7801503	PHC09R032SF16-3	32	20.2	3	17	M16	22	40	28	1	0.18			82,700
7801511	PHC09R033SF16-3	★ 33	21.2	3	17	M16	22	40	28	1	0.19			82,700
7801504	PHC09R035SF16-3	★ 35	23.2	3	17	M16	22	40	28	1	0.19			82,700
7801505	PHC09R040SF16-4	40	28.2	4	17	M16	22	40	28	1	0.22			102,000
7801506	PHC12R030SF16-2	30	13.4	2	17	M16	22	40	28	2	0.17	③	⑥	75,400
7801507	PHC12R032SF16-2	32	15.4	2	17	M16	22	40	28	2	0.18			75,400
7801512	PHC12R033SF16-2	★ 33	16.4	2	17	M16	22	40	28	2	0.19			91,000
7801508	PHC12R035SF16-3	★ 35	18.4	3	17	M16	22	40	28	2	0.18			91,000
7801509	PHC12R040SF16-3	40	23.4	3	17	M16	22	40	28	2	0.22			93,000

インサート及び部品はp.164をご覧ください。

See p.164 for inserts and accessories.

シャンクホルダについてはp.242～p.244をご覧ください。

See p.242-p.244 for shank holders.

★ 刃太タイプ
Reduced Shank Type

★ PHC 刃太タイプ Reduced Shank Type

・刃太タイプは、シャンク径よりも工具外径の方が大きいため、金型部品などの深い立ち壁加工やポケット加工に最適です

・The outer diameter of the reduced shank type is larger than the shank diameter, making it highly effective in the processing of die and mold applications that require vertical wall milling or pocketing.

例
Example

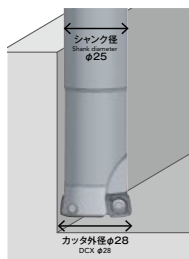

Specification

■形状寸法表 Specification

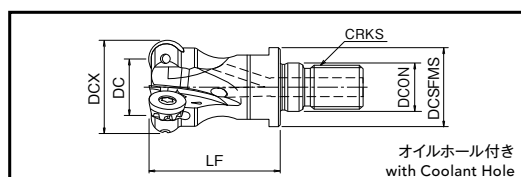

PRC ねじ込みタイプ Screw Fit Type

単位:mm Unit:mm

ツールNo. EDP No.	呼び Designation	カット外径 DCX	外径 DC	刃数 ZEPF	取付け径 DCON	ねじサイズ CRKS	スパナサイズ Spanner Size	全長 LF	端面径 DCSFMS	重量 (kg)	適用インサート Applicable Inserts	通径シャンクホルダタイプ Applicable Shank	標準価格 (Yen)
7801700	PRC10R020SF10-2	20	10	2	10.5	M10	14	33	18	0.06	①	④	57,300
7801701	PRC10R025SF12-3	25	15	3	12.5	M12	17	35	23	0.09		⑤	71,100
7801702	PRC10R030SF16-3	30	20	3	17	M16	22	40	28	0.16		⑥	78,900
7801703	PRC10R032SF16-4	32	22	4	17	M16	22	40	28	0.17			87,800
7801704	PRC10R040SF16-4	40	30	4	17	M16	22	40	28	0.21			96,900
7801705	PRC12R030SF16-2	30	18	2	17	M16	22	40	28	0.16	②	⑥	84,000
7801706	PRC12R032SF16-3	32	20	3	17	M16	22	40	28	0.16		⑥	87,100
7801707	PRC12R040SF16-3	40	28	3	17	M16	22	40	28	0.22			87,100

インサート及び部品はp.175をご覧ください。 See p.175 for inserts and accessories.
シャンクホルダについてはp.242～p.244をご覧ください。 See p.242-p.244 for shank holders.

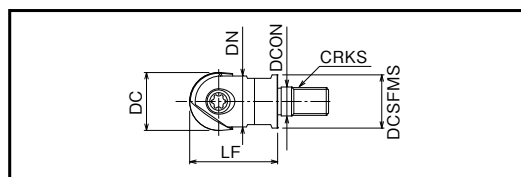

PFB ねじ込みタイプ Screw Fit Type

単位:mm Unit:mm

ツールNo. EDP No.	呼び Designation	外径 DC	刃数 ZEPF	取付け径 DCON	ねじサイズ CRKS	スパナサイズ Spanner Size	全長 LF	首径 DN	端面径 DCSFMS	通径シャンクホルダタイプ Applicable Shank	標準価格 (Yen)
③ 7801490	PFB-R100SF6	10	2	6.5	M 6	7	26	9	9	①	18,800
④ 7801491	PFB-R120SF6	12	2	6.5	M 6	7	26	11	11	②	19,300
⑤ 7801492	PFB-R160SF8	16	2	8.5	M 8	10	32	14	14.5	③	22,400
⑥ 7801493	PFB-R200SF10	20	2	10.5	M10	14	38	18	18	④	25,200
⑦ 7801494	PFB-R250SF12	25	2	12.5	M12	17	38	22	23	⑤	29,900
⑧ 7801495	PFB-R300SF16	30	2	17	M16	22	43	27	28	⑥	39,000

インサート及び部品はp.202～p.204、p.212～p.213をご覧ください。 See p.202-p.204 and p.212-p.213 for inserts and accessories.
シャンクホルダについてはp.242～p.244をご覧ください。 See p.242-p.244 for shank holders.

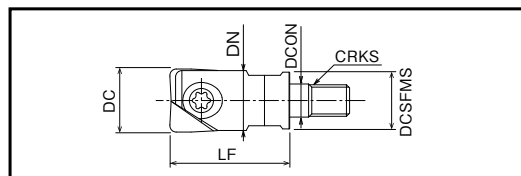

PFR ねじ込みタイプ Screw Fit Type

単位:mm Unit:mm

ツールNo. EDP No.	呼び Designation	外径 DC	刃数 ZEPF	取付け径 DCON	ねじサイズ CRKS	スパナサイズ Spanner Size	全長 LF	首径 DN	端面径 DCSFMS	通径シャンクホルダタイプ Applicable Shank	標準価格 (Yen)
③ 7832090	PFR-R100SF6	10	2	6.5	M 6	7	26	9	9	①	18,800
④ 7832091	PFR-R120SF6	12	2	6.5	M 6	7	26	11	11	②	19,300
⑤ 7832092	PFR-R160SF8	16	2	8.5	M 8	10	32	15	14.5	③	22,400
⑥ 7832093	PFR-R200SF10	20	2	10.5	M10	14	38	19	18	④	25,200
⑦ 7832094	PFR-R250SF12	25	2	12.5	M12	17	38	24	23	⑤	29,900
⑧ 7832095	PFR-R300SF16	30	2	17	M16	22	43	29	28	⑥	39,000
⑨ 7832096	PFR-R320SF16	32	2	17	M16	22	43	31	28	⑥	43,300

インサート及び部品はP.224～P.229をご覧ください。 See p.224-p.229 for inserts and accessories.
シャンクホルダについてはp.242～p.244をご覧ください。 See p.242-p.244 for shank holders.

Specification

■形状寸法表 Specification

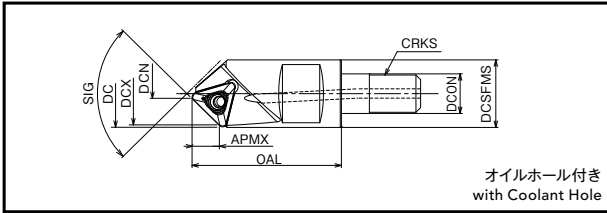

PLDS ねじ込みタイプ Screw Fit Type

単位:mm Unit:mm

ツールNo. EDP No.	呼び Designation	先端角 SIG	加工径		外径 DC	刃数 ZEPF	取付け径 DCON	ねじサイズ CRKS	スパナサイズ Spanner Size	全長 OAL	端面径 DCSFMS	APMX	重量 (kg)	適用シャンク ホルダタイプ Applicable Shank	標準価格 (Yen)
			最小 DCN	最大 DCX											
NEW 7803405	PLDS11R002SF8-90	90°	2.5	13.5	14.4	1	8.5	M8	10	32	14.5	5.8	0.05	③	12,700
NEW 7803406	PLDS11R002SF8-120	120°	2.4	16	17.3							4	0.05		

インサート及び部品はp.80をご覧ください。 See p.80 for inserts and accessories.
 シャンクホルダについてはp.242～p.244をご覧ください。 See p.242-p.244 for shank holders.

Specification

■形状寸法表 Specification

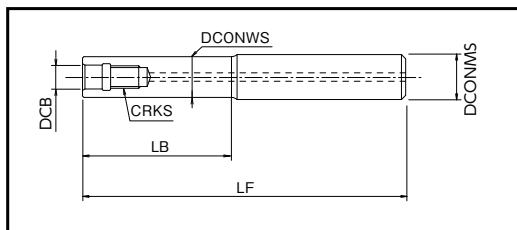

ねじ込みタイプ専用ストレートシャンクホルダ Straight Shank Holder for Screw Fit Type

鋼シャンク Steel Shank

単位:mm Unit:mm

①	ツールNo. EDP No.	呼び Designation	シャンク径 DCONMS	首径 DCONWS	ねじサイズ CRKS	取付け径 DCB	全長 LF	首下長 LB	標準価格 (Yen)
1	7801904	SF-M06SS10-4	10	9	M 6	6.5	104	2.3	20,300
2	7801905	SF-M06SS12-10	12	11	M 6	6.5	104	8.3	23,600
3	7801900	SF-M08SS16-15	16	14.5	M 8	8.5	95	13	26,300
4	7801901	SF-M10SS20-20	20	18	M10	10.5	120	17.7	27,900
5	7801902	SF-M12SS25-35	25	23	M12	12.5	135	32.7	29,700
6	7801903	SF-M16SS32-35	32	28	M16	17	155	32.1	32,600



オール超硬シャンク All Carbide Shank

単位:mm Unit:mm

①	ツールNo. EDP No.	呼び Designation	シャンク径 DCONMS	首径 DCONWS	ねじサイズ CRKS	取付け径 DCB	全長 LF	首下長 LB	標準価格 (Yen)
1	7801918	SF-M06SS10-24CS	10	9	M 6	6.5	124	22.3	33,100
2	7801919	SF-M06SS12-34CS	12	11	M 6	6.5	134	32.3	38,500
3	7801910	SF-M08SS16-55CS	16	14.5	M 8	8.5	115	53	43,800
	7801911	SF-M08SS16-85CS					145	83	52,400
4	7801912	SF-M10SS20-70CS	20	18	M10	10.5	140	67.7	62,600
	7801913	SF-M10SS20-110CS					180	107.7	75,400
5	7801914	SF-M12SS25-90CS	25	23	M12	12.5	170	87.7	93,400
	7801915	SF-M12SS25-140CS					220	137.7	117,000
6	7801916	SF-M16SS32-120CS	32	28	M16	17	220	117.1	148,000
	7801917	SF-M16SS32-190CS					290	187.1	193,000

Phoenix

ねじ込みタイプ専用ホルダ

Holder for Screw Fit Type

OP-SFA

Specification

■形状寸法表 Specification

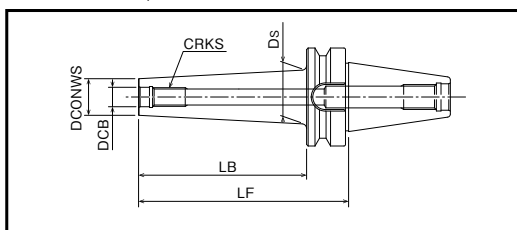

BT シャンクホルダ BT Shank Holder

単位:mm Unit:mm

	ツールNo. EDP No.	呼び Designation	首径 DCONWS	ねじサイズ CRKS	取付け径 DCB	機能長さ LF	首下長 LB	首元径 Ds	在庫 Stock	標準価格 (Yen)
③	7802500	BT30-SFA8-45	14.5	M 8	8.5	45	23	16	※	27,500
	7802501	BT30-SFA8-85				85	63	21.1	※	30,000
④	7802502	BT30-SFA10-45	18.5	M10	10.5	45	23	20	※	27,500
	7802503	BT30-SFA10-85				85	63	25.1	※	30,000
⑤	7802504	BT30-SFA12-45	23.5	M12	12.5	45	23	25	※	27,500
	7802505	BT30-SFA12-85				85	63	30.1	※	30,000
⑥	7802506	BT30-SFA16-45	29	M16	17	45	23	32	※	27,500
	7802507	BT30-SFA16-85				85	63	32	※	30,000
③	7802508	BT40-SFA8-45	14.5	M 8	8.5	45	18	16	※	30,000
	7802509	BT40-SFA8-85				85	58	20.5	※	32,900
④	7802510	BT40-SFA10-45	18.5	M10	10.5	45	18	20	※	30,000
	7802511	BT40-SFA10-85				85	58	24.5	※	32,900
⑤	7802512	BT40-SFA12-45	23.5	M12	12.5	45	18	25	※	30,000
	7802513	BT40-SFA12-85				85	58	29.5	※	32,900
	7802514	BT40-SFA12-135				135	108	34.8	※	37,000
⑥	7802515	BT40-SFA16-45	29	M16	17	45	18	32	※	30,000
	7802516	BT40-SFA16-85				85	58	35	※	32,900
	7802517	BT40-SFA16-135				135	108	40.3	※	37,000
③	7802518	BT50-SFA8-85	14.5	M 8	8.5	85	47	19.4	※	35,800
	7802519	BT50-SFA8-135				135	97	24.6	※	38,500
④	7802520	BT50-SFA10-85	18.5	M10	10.5	85	47	20	※	35,800
	7802521	BT50-SFA10-135				135	97	28.6	※	38,500
⑤	7802522	BT50-SFA12-85	23.5	M12	12.5	85	47	25	※	35,800
	7802523	BT50-SFA12-135				135	97	33.6	※	38,500
	7802524	BT50-SFA12-185				185	147	38.9	※	45,200
	7802525	BT50-SFA12-250				250	212	45.7	※	51,800
	7802526	BT50-SFA12-300				300	262	50.9	※	61,600
⑥	7802527	BT50-SFA16-85	29	M16	17	85	47	32	※	35,800
	7802528	BT50-SFA16-135				135	97	39.1	※	38,500
	7802529	BT50-SFA16-185				185	147	44.4	※	45,200
	7802530	BT50-SFA16-250				250	212	51.2	※	51,800
	7802531	BT50-SFA16-300				300	262	56.4	※	61,600

■形状寸法表 Specification

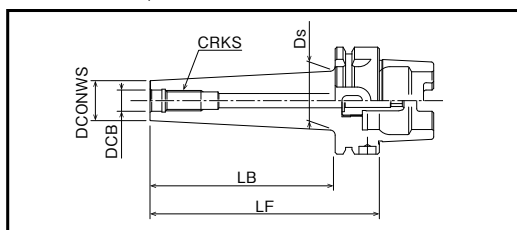

HSK シャンクホルダ HSK Shank Holder

単位:mm Unit:mm

	ツールNo. EDP No.	呼び Designation	首径 DCONWS	ねじサイズ CRKS	取付け径 DCB	機能長さ LF	首下長 LB	首元径 Ds	在庫 Stock	標準価格 (Yen)
③	7802550	A63-SFA8-45	14.5	M 8	8.5	45	19	16	※	41,100
	7802551	A63-SFA8-85				85	59	20.6	※	43,800
④	7802552	A63-SFA10-60	18.5	M10	10.5	60	34	20	※	41,100
	7802553	A63-SFA10-85				85	59	24.6	※	43,800
⑤	7802554	A63-SFA12-60	23.5	M12	12.5	60	34	25	※	41,100
	7802555	A63-SFA12-85				85	59	29.6	※	43,800
	7802556	A63-SFA12-135				135	109	34.9	※	51,800
⑥	7802557	A63-SFA16-60	29	M16	17	60	34	32	※	41,100
	7802558	A63-SFA16-85				85	59	32	※	43,800
	7802559	A63-SFA16-135				135	109	40.4	※	51,800
③	7802560	A100-SFA8-85	14.5	M 8	8.5	85	50	19.7	※	51,800
	7802561	A100-SFA8-135				135	100	24.9	※	57,500
④	7802562	A100-SFA10-85	18.5	M10	10.5	85	50	23.7	※	51,800
	7802563	A100-SFA10-135				135	100	28.9	※	57,500
⑤	7802564	A100-SFA12-85	23.5	M12	12.5	85	50	28.7	※	51,800
	7802565	A100-SFA12-135				135	100	33.9	※	57,500
	7802566	A100-SFA12-185				185	150	39.2	※	65,500
	7802567	A100-SFA12-250				250	221	46.6	※	71,100
	7802568	A100-SFA12-300				300	271	51.9	※	81,900
⑥	7802569	A100-SFA16-85	29	M16	17	85	50	34.2	※	51,800
	7802570	A100-SFA16-135				135	106	40.1	※	57,500
	7802571	A100-SFA16-185				185	156	45.3	※	65,500
	7802572	A100-SFA16-250				250	221	52.1	※	71,100
	7802573	A100-SFA16-300				300	271	57.4	※	81,900

Phoenix PXM

ヘッド交換式エンドミル
Exchangeable Head End Mill

Phoenix Exchangeable Milling

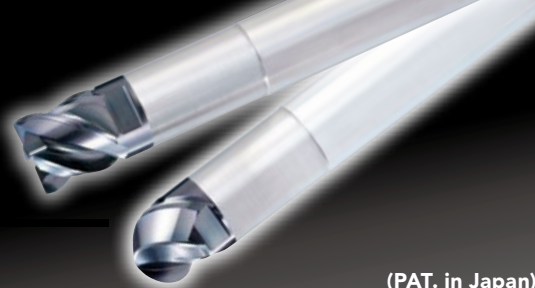

(PAT. in Japan)

特長 Features

ソリッドエンドミルの設計・実績・ノウハウを活かした刃形

・様々な加工に対応可能

All the knowledge and know-how acquired by designing solid carbide end mills are found in these exchangeable heads.
・Various types are available to meet variety of machining methods.

端面 + テーパー = 二面拘束

- ・高い剛性と精度を確保
- ・外周刃の振れ精度：0.015mm 以下
- ・ヘッド交換精度(軸方向) ±0.03mm

End Face + Tapper = Double Face Clamping
・High rigidity and accuracy of tightening
・High precision of run out ≤0.015mm
・High head replacing accuracy = ±0.03mm



PXVC



PXM 専用スパナによる締結

Tighten by the spanner exclusive for PXM.
(Sold separately from the cutters)

バットレスネジ採用

- ・ヘッドの脱着が容易に
- ・工具交換時間の短縮

Applying buttress screw makes easy and reduces time to desorb heads.

対
ソリッド工具
Compared to
solid tools

大径加工でのコストメリット。
ヘッドのみの交換による時間短縮。
The large diameter offers cost advantages.
To reduce the tool changing time, only the
cutter chip needs to be replaced.

対
インデキサブル工具
Compared to
indexable
tools

刃数メリットによる生産性の向上。刃先の自由度。
インシャルコスト、ランニングコストの低減。
It provides flute quantity advantages to improve productivity, as
well as a selection of cutter chips. It offers additional advantages
in terms of initial costs and running costs.

ヘッドラインナップ Line up of exchangeable heads

PXSE	不等分割 4枚刃 スクエア・コーナラジラス形状 Unequal Spacing, Four Flutes, Square-Corner Radius Type	汎用性が高く、溝～側面まで、重切削が可能 As a general-purpose tool, it can be used for heavy cutting from grooves to side faces.
PXVC	不等リード 4枚刃 強ねじれ スクエア・コーナラジラス形状 Variable Lead, Four Flutes, High Helix, Square-Corner Radius Type	突出しの長い加工において、安定した加工が可能 Stable machining with long overhang length.
PXSM	不等分割 多刃 スクエア・コーナラジラス形状 Unequal Spacing, Multiple Flutes, Square-Corner Radius Type	汎用性が高く、多刃のメリットを活かす加工が可能 As a general-purpose tool, it can bring the advantages of multiple cutters into full play.
NEW PXAL	3枚刃 スクエア・コーナラジラス形状 Three Flutes, Square-Corner Radius Type	非鉄金属の高効率加工が可能 Highly efficient milling of non-ferrous materials.
PXNH	不等リード 4枚刃 強ねじれ ラフィング形状 Variable Lead, Four Flutes, High Helix, Roughing Type	幅広い切削領域で荒取り加工が可能 Suitable for rough milling in a wide range of cutting conditions.
PXNL	不等リード 4枚刃 弱ねじれ ラフィング形状 Variable Lead, Four Flutes, Low Helix, Roughing Type	長寿命の荒取り加工が可能 Suitable for rough milling with a long tool life.
PXRE	直刃 コーナラジラス形状 Straight Flutes, Corner Radius Type	高硬度材の加工が可能 It can mill high hardness materials.
PXDR-P	3枚刃 能力型 コーナラジラス形状 Three Flutes, Multi-purpose, Corner Radius Type	突出しの長くなる形状の安定加工が可能 Suitable for machining work which requires long overhang length.
PXDR-N	3枚刃 耐久型 コーナラジラス形状 Three Flutes, Heavy-duty, Corner Radius Type	長寿命の形状荒取り加工が可能 Suitable for profile milling with long tool life.
NEW PXSH	不等分割 多刃 スクエア形状 Unequal Spacing, Multiple Flutes, Square Type	70HRCまでの高硬度材の加工が可能 Milling of high-hardness materials up to 70 HRC.
NEW PXHF-AM	多刃 高送りラジラス形状 Multiple Flutes, High Feed Radius Type	金属積層材、高硬度材の高効率加工が可能 Highly efficient milling of metal laminates and high-hardness materials.
PXBE-P	3枚刃 能力型 ボール形状 Three Flutes, Multi-purpose, Ball Type	突出しの長くなる形状の安定加工が可能 Suitable for machining work which requires long overhang length.
PXBE-N	3枚刃 耐久型 ボール形状 Three Flutes, Heavy-duty, Ball Type	長寿命の形状荒取り加工が可能 Suitable for profile milling with long tool life.
PXBM	多刃 ボール形状 Multiple Flutes, Ball Type	中仕上げ～仕上げ加工が可能 It can be used for intermediate-finish and finish milling.

Features

■ PXMシリーズ 形状別工具ガイド

Group map by types of exchangeable heads

■ スクエア形状 Square Type

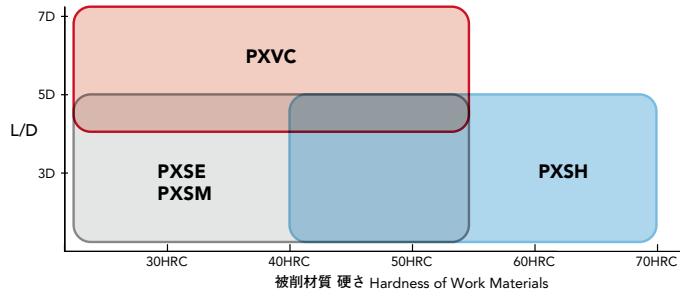

■ ラフィング形状 Roughing Type

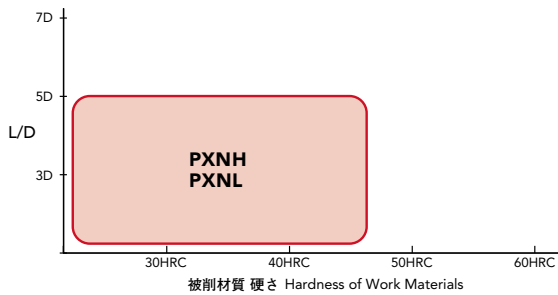
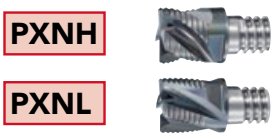

■ ラジラス形状 Radius Type

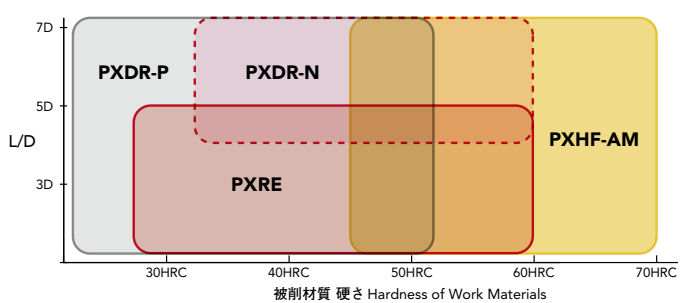

■ ボール形状 Ball Type

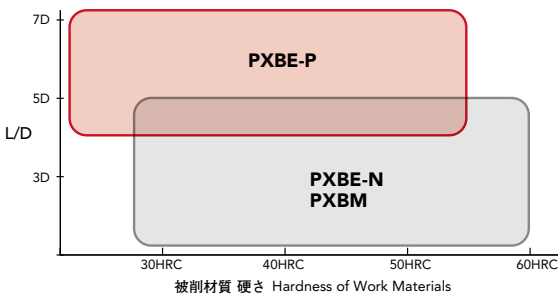
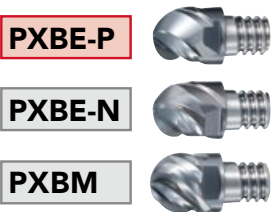

Phoenix PXM

スクエア・コーナラジアス形状

Square · Corner Radius Type

PXSE

Specification

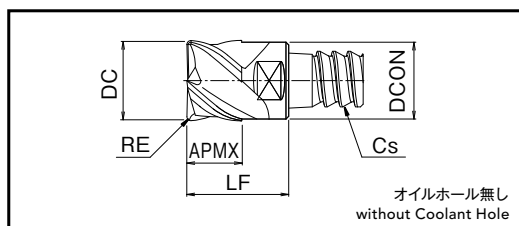

オイルホール無し without Coolant Hole

PXSE 不等分割 4枚刃 スクエア・コーナラジアス形状 Unequal Spacing, Four Flutes, Square · Corner Radius Type

単位:mm Unit:mm

ツールNo. EDP No.	呼び Designation	外径 DC	コーナ半径 RE	刃数 ZEPF	刃長 APMX	全長 LF	首径 DCON	ねじれ角 FHA	締結規格 Cs	材種 Grades	標準価格 (Yen)
7829994	PXSE100C10-04R000	10	0	4	7	13	9.7	38°	C10	XP3225	10,600
7829995	PXSE100C10-04R005		0.5								10,600
7829996	PXSE100C10-04R010		1								10,600
7829997	PXSE100C10-04R020		2								10,600
7829998	PXSE100C10-04R030		3								10,600
7830004	PXSE120C12-04R000	12	0	4	8.4	14.4	11.7	38°	C12	XP3225	11,200
7830005	PXSE120C12-04R005		0.5								11,200
7830006	PXSE120C12-04R010		1								11,200
7830007	PXSE120C12-04R020		2								11,200
7830008	PXSE120C12-04R030		3								11,200
7830009	PXSE160C16-04R000	16	0	4	11.2	18.7	15.7	38°	C16	XP3225	17,300
7830010	PXSE160C16-04R005		0.5								17,300
7830011	PXSE160C16-04R010		1								17,300
7830012	PXSE160C16-04R015		1.5								17,300
7830013	PXSE160C16-04R020		2								17,300
7830014	PXSE160C16-04R030		3								17,300
7830015	PXSE200C20-04R000	20	0	4	14	21.5	19.6	38°	C20	XP3225	20,100
7830016	PXSE200C20-04R005		0.5								20,100
7830017	PXSE200C20-04R010		1								20,100
7830018	PXSE200C20-04R020		2								20,100
7830019	PXSE200C20-04R030		3								20,100
7830020	PXSE250C25-04R000	25	0	4	17.5	27.5	24	38°	C25	XP3225	26,300
7830021	PXSE250C25-04R010		1								26,300
7830022	PXSE250C25-04R020		2								26,300
7830023	PXSE250C25-04R030		3								26,300

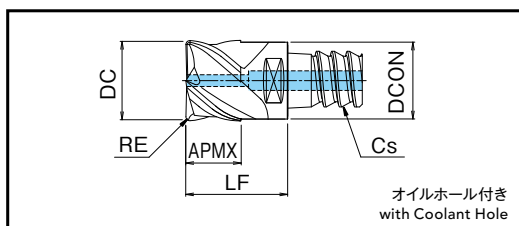
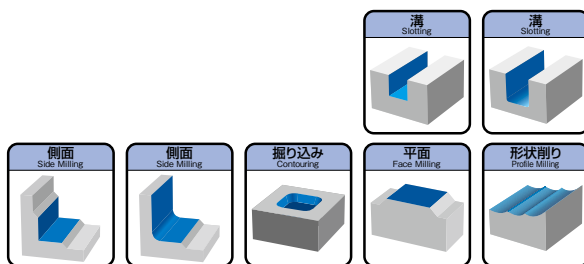

オイルホール付き with Coolant Hole

PXSE 不等分割 4枚刃 スクエア・コーナラジラス形状 Unequal Spacing, Four Flutes, Square · Corner Radius Type

単位:mm Unit:mm

ツールNo. EDP No.	呼び Designation	外径 DC	コーナ半径 RE	刃数 ZEFP	刃長 APMX	全長 LF	首径 DCON	ねじれ角 FHA	締結規格 Cs	材種 Grades	標準価格 (Yen)
7830054	PXSE120C12-04R000-O	12	0	4	8.4	14.4	11.7	38°	C12	XP3225	13,400
7830056	PXSE120C12-04R010-O		1								13,400
7830058	PXSE120C12-04R030-O		3								13,400
7830059	PXSE160C16-04R000-O	16	0	4	11.2	18.7	15.7	38°	C16	XP3225	20,800
7830061	PXSE160C16-04R010-O		1								20,800
7830064	PXSE160C16-04R030-O		3								20,800
7830065	PXSE200C20-04R000-O	20	0	4	14	21.5	19.6	38°	C20	XP3225	24,100
7830067	PXSE200C20-04R010-O		1								24,100
7830069	PXSE200C20-04R030-O		3								24,100
7830070	PXSE250C25-04R000-O	25	0	4	17.5	27.5	24	38°	C25	XP3225	31,600
7830071	PXSE250C25-04R010-O		1								31,600
7830074	PXSE250C25-04R030-O		3								31,600

1. 内部給油をご利用の際は、オイルホール付きのヘッドとシャンクホルダをご使用下さい。シャンクホルダについてはp.264・p.266をご覧ください。
 1. For the use of internal coolant, please use the appropriate head and shank holders with oil hole. Refer to pages 264 and 266 for details on shank holders.

Phoenix PXM

スクエア・コーナラジアス形状

Square - Corner Radius Type

PXVC

Specification

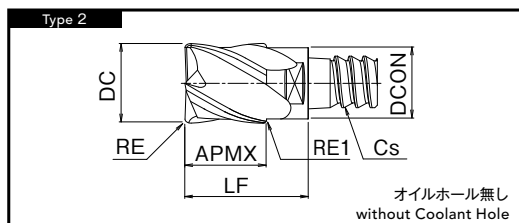
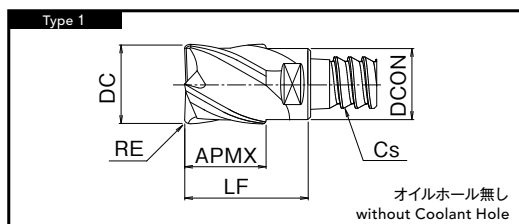

オイルホール無し without Coolant Hole

PXVC 不等リード 4枚刃 強ねじれ スクエア・コーナラジアス形状 Variable Lead, Four Flutes, High helix, Square - Corner Radius Type

単位:mm Unit:mm

ツールNo. EDP No.	呼び Designation	外径 DC	コーナ半径 RE	刃数 ZEFP	刃長 APMX	全長 LF	首径 DCON	ねじれ角 FHA	締結規格 Cs	材種 Grades	形状 Type	標準価格 (Yen)
7834994	PXVC100C10-04R000	10	0	4	10	16	9.8	45/48°	C10	XP3225	1	12,700
7834995	PXVC100C10-04R005		0.5									12,700
7834996	PXVC100C10-04R010		1									12,700
7834997	PXVC100C10-04R020		2									12,700
7834998	PXVC100C10-04R030		3									12,700
7834999	PXVC120C10-04R000	★ 12	0	4	12	18	9.8	45/48°		XP3225	2	13,400
7835000	PXVC120C10-04R005		0.5									13,400
7835001	PXVC120C10-04R010		1									13,400
7835002	PXVC120C10-04R020		2									13,400
7835003	PXVC120C10-04R030		3									13,400
7835004	PXVC120C12-04R000	12	0	4	12	18	11.7	45/48°	C12	XP3225	1	13,400
7835005	PXVC120C12-04R005		0.5									13,400
7835006	PXVC120C12-04R010		1									13,400
7835007	PXVC120C12-04R020		2									13,400
7835008	PXVC120C12-04R030		3									13,400
7835009	PXVC140C12-04R000	★ 14	0	4	14	20	11.7	45/48°		XP3225	2	18,500
7835010	PXVC140C12-04R005		0.5									18,500
7835011	PXVC140C12-04R010		1									18,500
7835012	PXVC140C12-04R020		2									18,500
7835013	PXVC140C12-04R030		3									18,500

▶ NEXT

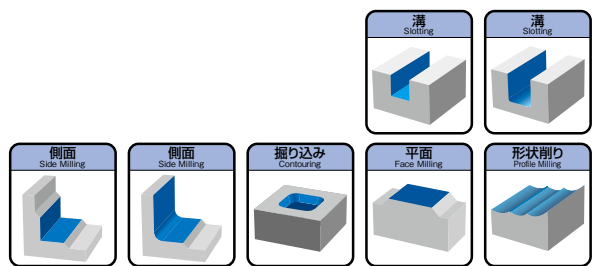

★ PXVC 刃太タイプ
Reduced Shank Type

刃太タイプは、シャンク径よりも工具外径の方が大きいいため、金型部品などの深い立ち壁加工やポケット加工に最適です

The outer diameter of the reduced shank type is larger than the shank diameter, making it highly effective in the processing of die and mold applications that require vertical wall milling or pocketing.

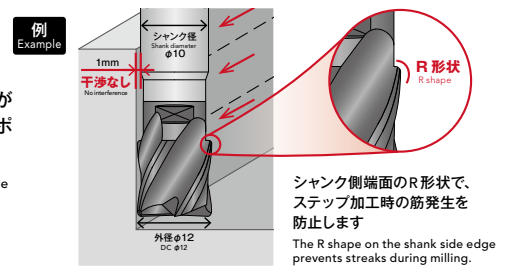

FROM

PXVC 不等リード 4枚刃 強ねじれ スクエア・コーナラジラス形状 Variable Lead, Four Flutes, High helix, Square · Corner Radius Type 単位:mm Unit:mm

ツールNo. EDP No.	呼び Designation	外径 DC	コーナ半径 RE	刃数 ZFP	刃長 APMX	全長 LF	首径 DCON	ねじれ角 FHA	締結規格 Cs	材種 Grades	形状 Type	標準価格 (Yen)
7835014	PXVC160C16-04R000	16	0	4	16	23.5	15.7	45/48°	C16	XP3225	1	20,800
7835015	PXVC160C16-04R005		0.5									20,800
7835016	PXVC160C16-04R010		1									20,800
7835017	PXVC160C16-04R015		1.5									20,800
7835018	PXVC160C16-04R020		2									20,800
7835019	PXVC160C16-04R030		3									20,800
7835020	PXVC180C16-04R000	★ 18	0	4	18	25.5	15.7	45/48°	XP3225	2	23,100	
7835021	PXVC180C16-04R005		0.5								23,100	
7835022	PXVC180C16-04R010		1								23,100	
7835023	PXVC180C16-04R020		2								23,100	
7835024	PXVC180C16-04R030		3								23,100	
7835025	PXVC200C20-04R000		20								0	4
7835026	PXVC200C20-04R005	0.5		24,100								
7835027	PXVC200C20-04R010	1		24,100								
7835028	PXVC200C20-04R020	2		24,100								
7835029	PXVC200C20-04R030	3		24,100								
7835030	PXVC220C20-04R000	★ 22		0	4	22	29.5	19.6	45/48°	XP3225	2	
7835038	PXVC220C20-04R005		0.5	29,400								
7835031	PXVC220C20-04R010		1	29,400								
7835032	PXVC220C20-04R020		2	29,400								
7835033	PXVC220C20-04R030		3	29,400								
7835034	PXVC250C25-04R000		25	0								4
7835035	PXVC250C25-04R010	1		31,600								
7835036	PXVC250C25-04R020	2		31,600								
7835037	PXVC250C25-04R030	3		31,600								
7835039	PXVC320C32-05R010	32	1	5	32	44.7	28	45°	C32	XP3225	1	97,800
7835040	PXVC320C32-08R010			8				38°				111,000

Phoenix PXM

スクエア・コーナラジラス形状

Square · Corner Radius Type

PXSM

Specification

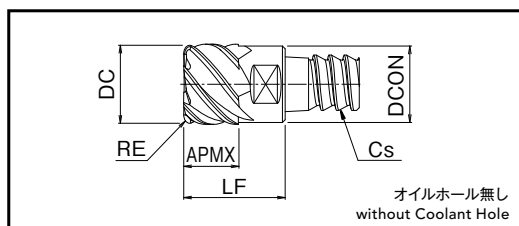

オイルホール無し without Coolant Hole

PXSM 不等分割 多刃 スクエア・コーナラジラス形状 Unequal Spacing, Multiple Flutes, Square · Corner Radius Type

単位:mm Unit:mm

ツールNo. EDP No.	呼び Designation	外径 DC	コーナ半径 RE	刃数 ZEPF	刃長 APMX	全長 LF	首径 DCON	ねじれ角 FHA	締結規格 Cs	材種 Grades	標準価格 (Yen)
7830094	PXSM100C10-06R000	10	0	6	7	13	9.7	38°	C10	XP3225	12,900
7830095	PXSM100C10-06R005		0.5								12,900
7830096	PXSM100C10-06R010		1								12,900
7830097	PXSM100C10-06R020		2								12,900
7830104	PXSM120C12-06R000	12	0	6	8.4	14.4	11.7	38°	C12	XP3225	13,200
7830105	PXSM120C12-06R005		0.5								13,200
7830106	PXSM120C12-06R010		1								13,200
7830107	PXSM120C12-06R020		2								13,200
7830108	PXSM120C12-06R030		3								13,200
7830109	PXSM160C16-06R000	16	0	6	11.2	18.7	15.7	38°	C16	XP3225	19,000
7830110	PXSM160C16-06R005		0.5								19,000
7830111	PXSM160C16-06R010		1								19,000
7830112	PXSM160C16-06R015		1.5								19,000
7830113	PXSM160C16-06R020		2								19,000
7830114	PXSM160C16-06R030		3	19,000							
7830115	PXSM160C16-08R000		0	8				42°			21,700
7830116	PXSM160C16-08R005		0.5								21,700
7830117	PXSM160C16-08R010		1								21,700
7830118	PXSM160C16-08R015		1.5								21,700
7830119	PXSM160C16-08R020	2	21,700								
7830120	PXSM160C16-08R030	3	21,700								

NEXT →

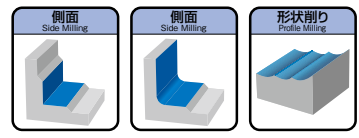

FROM

PXSM 不等分割 多刃 スクエア・コーナラジラス形状 Unequal Spacing, Multiple Flutes, Square · Corner Radius Type

単位:mm Unit:mm

ツールNo. EDP No.	呼び Designation	外径 DC	コーナ半径 RE	刃数 ZEFP	刃長 APMX	全長 LF	首径 DCON	ねじれ角 FHA	締結規格 Cs	材種 Grades	標準価格 (Yen)
7830121	PXSM200C20-10R000	20	0	10	14	21.5	19.6	42°	C20	XP3225	30,000
7830122	PXSM200C20-10R005		0.5								30,000
7830123	PXSM200C20-10R010		1								30,000
7830124	PXSM200C20-10R020		2								30,000
7830125	PXSM200C20-10R030		3								30,000
7830126	PXSM250C25-10R000	25	0	10	17.5	27.5	24	42°	C25	XP3225	34,000
7830127	PXSM250C25-10R010		1								34,000
7830128	PXSM250C25-10R020		2								34,000
7830129	PXSM250C25-10R030		3								34,000

Phoenix PXM

スクエア・コーナラジラス形状

Square · Corner Radius Type

PXAL

Specification

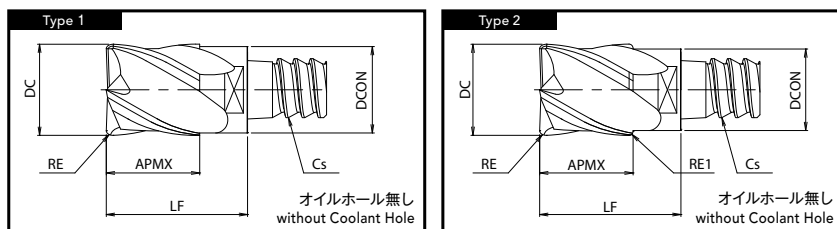

コーティングに色むらが発生する場合がありますが、性能上は全く問題ありません。

End mills may have some discoloration, but it does not cause any performance problems.

オイルホール無し without Coolant Hole

PXAL 3枚刃 スクエア・コーナラジラス形状 Three Flutes, Square · Corner Radius Type

単位:mm Unit:mm

ツールNo. EDP No.	呼び Designation	外径 DC	コーナ半径 RE	刃数 ZEFP	刃長 APMX	全長 LF	首径 DCON	ねじれ角 FHA	締結規格 Cs	材種 Grades	形状タイプ Type	標準価格 (Yen)
NEW 7834930	PXAL100C10-03R000	10	0	3	10	16	9.8	45°	C10	XP4625	1	12,700
NEW 7834931	PXAL100C10-03R100		1								1	12,700
NEW 7834932	PXAL100C10-03R250		2.5								1	12,700
NEW 7834933	PXAL120C10-03R000	★12	0	3	12	18	9.8	45°	C12	XP4625	2	13,400
NEW 7834934	PXAL120C12-03R000	12	0	3	12	18	11.7	45°			1	13,400
NEW 7834935	PXAL120C12-03R100		1								1	13,400
NEW 7834936	PXAL120C12-03R300		3						1	13,400		
NEW 7834937	PXAL140C12-03R000	★14	0	3	14	20	11.7	45°	C16	XP4625	2	18,500
NEW 7834938	PXAL160C16-03R000	16	0	3	16	23.5	15.7	45°			1	20,800
NEW 7834939	PXAL160C16-03R100		1								1	20,800
NEW 7834940	PXAL160C16-03R200		2						1	20,800		
NEW 7834941	PXAL160C16-03R300		3						1	20,800		
NEW 7834942	PXAL160C16-03R400		4						1	20,800		
NEW 7834943	PXAL180C16-03R000	★18	0	3	18	25.5	15.7	45°	XP4625	2	23,100	

★ 刃太タイプ
Reduced Shank Type

NEXT

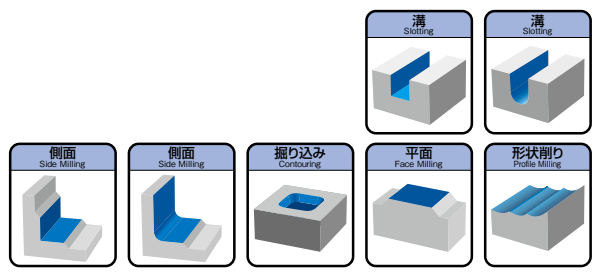

FROM

PXAL 3枚刃 スクエア・コーナラジラス形状 Three Flutes, Square-Corner Radius Type

単位:mm Unit:mm

ツールNo. EDP No.	呼び Designation	外径 DC	コーナ半径 RE	刃数 ZEPF	刃長 APMX	全長 LF	首径 DCON	ねじれ角 FHA	締結規格 Cs	材種 Grades	形状タイプ Type	標準価格 (Yen)
NEW 7834944	PXAL200C20-03R000	20	0	3	20	27.5	19.6	45°	C20	XP4625	1	24,100
NEW 7834945	PXAL200C20-03R100		1								1	24,100
NEW 7834946	PXAL200C20-03R200		2								1	24,100
NEW 7834947	PXAL200C20-03R300		3								1	24,100
NEW 7834948	PXAL200C20-03R400		4								1	24,100
NEW 7834949	PXAL220C20-03R000	★22	0	3	22	29.5	19.6	45°		XP4625	2	29,400
NEW 7834950	PXAL250C25-03R000	25	0	3	25	35	24	45°	C25	XP4625	1	31,600
NEW 7834951	PXAL250C25-03R100		1								1	31,600
NEW 7834952	PXAL250C25-03R300		3								1	31,600
NEW 7834953	PXAL250C25-03R500		5								1	31,600

★ PXAL 刃太タイプ
Reduced Shank Type

・刃太タイプは、シャンク径よりも工具外径の方が大きいいため、金型部品などの深い立ち壁加工やポケット加工に最適です

・The outer diameter of the reduced shank type is larger than the shank diameter, making it highly effective in the processing of die and mold applications that require vertical wall milling or pocketing.

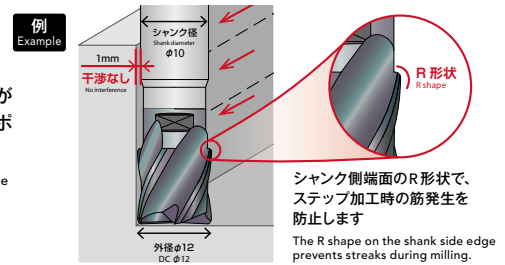

Phoenix PXM

ラフィング形状

Roughing Type

PXNH

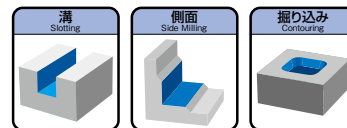

Specification

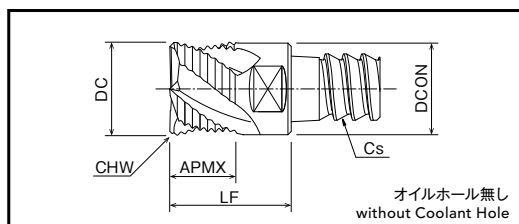

オイルホール無し without Coolant Hole

PXNH 不等リード 4枚刃 強ねじれ ラフィング形状 Variable Lead, Four Flutes, High Helix, Roughing Type

単位:mm Unit:mm

ツールNo. EDP No.	呼び Designation	外径 DC	コーナ 面取幅 CHW	刃数 ZEPF	刃長 APMX	全長 LF	首径 DCON	ねじれ角 FHA	締結規格 Cs	材種 Grades	標準価格 (Yen)
7830450	PXNH100C10-04C005	10	0.5	4	7	13	9.7	40/42°	C10	XP3225	11,800
7830451	PXNH120C12-04C005	12	0.5	4	8.4	14.4	11.7	40/42°	C12	XP3225	12,100
7830452	PXNH160C16-04C006	16	0.6	4	11.2	18.7	15.7	40/42°	C16	XP3225	19,700
7830453	PXNH200C20-04C006	20	0.6	4	14	21.5	19.6	40/42°	C20	XP3225	24,100
7830454	PXNH250C25-04C006	25	0.6	4	17.5	27.5	24	40/42°	C25	XP3225	33,200

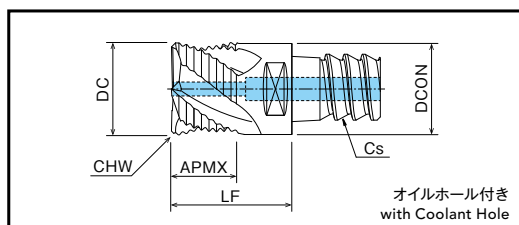

オイルホール付き with Coolant Hole

PXNH 不等リード 4枚刃 強ねじれ ラフィング形状 Variable Lead, Four Flutes, High Helix, Roughing Type

単位:mm Unit:mm

ツールNo. EDP No.	呼び Designation	外径 DC	コーナ 面取幅 CHW	刃数 ZEPF	刃長 APMX	全長 LF	首径 DCON	ねじれ角 FHA	締結規格 Cs	材種 Grades	標準価格 (Yen)
7830461	PXNH120C12-04C005-O	12	0.5	4	8.4	14.4	11.7	40/42°	C12	XP3225	14,600
7830462	PXNH160C16-04C006-O	16	0.6	4	11.2	18.7	15.7	40/42°	C16	XP3225	23,800
7830463	PXNH200C20-04C006-O	20	0.6	4	14	21.5	19.6	40/42°	C20	XP3225	28,900
7830464	PXNH250C25-04C006-O	25	0.6	4	17.5	27.5	24	40/42°	C25	XP3225	40,100

1. 内部給油をご利用の際は、オイルホール付きのヘッドとシャンクホルダをご使用下さい。シャンクホルダについてはp.264・p.266をご覧ください。

1. For the use of internal coolant, please use the appropriate head and shank holders with oil hole. Refer to pages 264 and 266 for details on shank holders.

Phoenix PXM

ラフィング形状

Roughing Type

PXNL

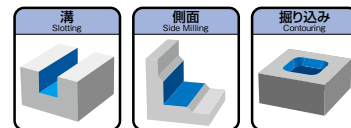

Specification

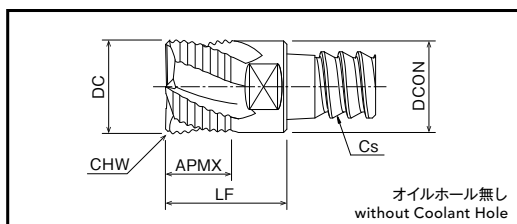

オイルホール無し without Coolant Hole

PXNL 不等リード 4枚刃 弱ねじれ ラフィング形状 Variable Lead, Four Flutes, Low Helix, Roughing Type

単位:mm Unit:mm

ツールNo. EDP No.	呼び Designation	外径 DC	コーナ 面取幅 CHW	刃数 ZEFP	刃長 APMX	全長 LF	首径 DCON	ねじれ角 FHA	締結規格 Cs	材種 Grades	標準価格 (Yen)
7830400	PXNL100C10-04C005	10	0.5	4	7	13	9.7	19/21°	C10	XP3225	11,800
7830401	PXNL120C12-04C005	12	0.5	4	8.4	14.4	11.7	19/21°	C12	XP3225	12,100
7830402	PXNL160C16-04C006	16	0.6	4	11.2	18.7	15.7	19/21°	C16	XP3225	19,700
7830403	PXNL200C20-04C006	20	0.6	4	14	21.5	19.6	19/21°	C20	XP3225	24,100
7830404	PXNL250C25-04C006	25	0.6	4	17.5	27.5	24	19/21°	C25	XP3225	33,200

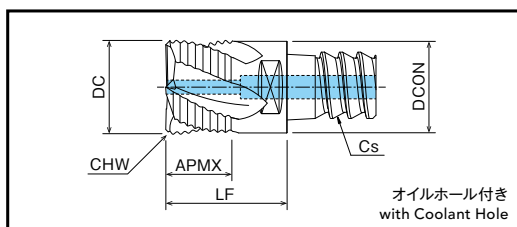

オイルホール付き with Coolant Hole

PXNL 不等リード 4枚刃 弱ねじれ ラフィング形状 Variable Lead, Four Flutes, Low Helix, Roughing Type

単位:mm Unit:mm

ツールNo. EDP No.	呼び Designation	外径 DC	コーナ 面取幅 CHW	刃数 ZEFP	刃長 APMX	全長 LF	首径 DCON	ねじれ角 FHA	締結規格 Cs	材種 Grades	標準価格 (Yen)
7830411	PXNL120C12-04C005-O	12	0.5	4	8.4	14.4	11.7	19/21°	C12	XP3225	14,600
7830412	PXNL160C16-04C006-O	16	0.6	4	11.2	18.7	15.7	19/21°	C16	XP3225	23,800
7830413	PXNL200C20-04C006-O	20	0.6	4	14	21.5	19.6	19/21°	C20	XP3225	28,900
7830414	PXNL250C25-04C006-O	25	0.6	4	17.5	27.5	24	19/21°	C25	XP3225	40,100

1. 内部給油をご利用の際は、オイルホール付きのヘッドとシャンクホルダをご利用下さい。シャンクホルダについてはp.264・p.266をご覧ください。

1. For the use of internal coolant, please use the appropriate head and shank holders with oil hole. Refer to pages 264 and 266 for details on shank holders.

Phoenix PXM

コーナラジアス形状

Corner Radius Type

PXRE

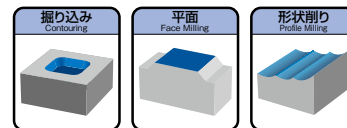

Specification

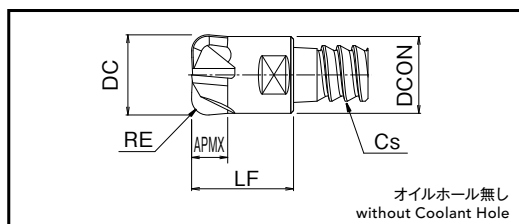

オイルホール無し without Coolant Hole

PXRE 直刃 コーナラジアス形状 Straight Flutes, Corner Radius Type

単位:mm Unit:mm

ツールNo. EDP No.	呼び Designation	外径 DC	コーナ半径 RE	刃数 ZEPF	刃長 APMX	全長 LF	首径 DCON	ねじれ角 FHA	締結規格 Cs	材種 Grades	標準価格 (Yen)
7830200	PXRE100C10-04R020	10	2	4	4.5	13	9.7	-	C10	XP6305	13,200
7830201	PXRE120C12-04R020	12	2	4	5	14.4	11.7	-	C12	XP6305	13,700
7830202	PXRE160C16-06R030	16	3	6	7	18.7	15.7	-	C16	XP6305	24,100
7830203	PXRE200C20-06R030	20	3	6	10	21.5	19.6	-	C20	XP6305	26,700

Phoenix PXM

コーナラジラス形状

Corner Radius Type

PXDR

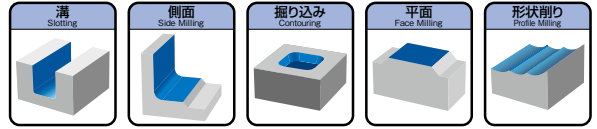

Specification

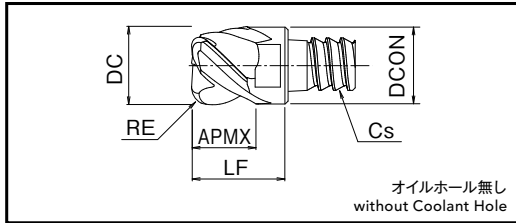

オイルホール無し without Coolant Hole

PXDR-P 3枚刃 能力型 コーナラジラス形状 Three Flutes, Multi-purpose, Corner Radius Type

単位:mm Unit:mm

ツールNo. EDP No.	呼び Designation	外径 DC	コーナ半径 RE	刃数 ZEFP	刃長 APMX	全長 LF	首径 DCON	ねじれ角 FHA	締結規格 Cs	材種 Grades	標準価格 (Yen)
7830349	PXDR100C10-03R015-P	10	1.5	3	7	13	9.7	45°	C10	XP3225	10,600
7830350	PXDR100C10-03R020-P		2								10,600
7830351	PXDR120C12-03R015-P	12	1.5	3	8.4	14.4	11.7	45°	C12	XP3225	11,200
7830352	PXDR120C12-03R020-P		2								11,200
7830353	PXDR160C16-03R020-P	16	2	3	11.2	18.7	15.7	45°	C16	XP3225	17,300
7830354	PXDR160C16-03R030-P		3								17,300
7830355	PXDR200C20-03R020-P	20	2	3	14	21.5	19.6	45°	C20	XP3225	20,100
7830356	PXDR200C20-03R030-P		3								20,100

PXDR-N 3枚刃 耐久型 コーナラジラス形状 Three Flutes, Heavy-duty, Corner Radius Type

単位:mm Unit:mm

ツールNo. EDP No.	呼び Designation	外径 DC	コーナ半径 RE	刃数 ZEFP	刃長 APMX	全長 LF	首径 DCON	ねじれ角 FHA	締結規格 Cs	材種 Grades	標準価格 (Yen)
7830369	PXDR100C10-03R015-N	10	1.5	3	7	13	9.7	45°	C10	XP6305	10,600
7830370	PXDR100C10-03R020-N		2								10,600
7830371	PXDR120C12-03R015-N	12	1.5	3	8.4	14.4	11.7	45°	C12	XP6305	11,200
7830372	PXDR120C12-03R020-N		2								11,200
7830373	PXDR160C16-03R020-N	16	2	3	11.2	18.7	15.7	45°	C16	XP6305	17,300
7830374	PXDR160C16-03R030-N		3								17,300
7830375	PXDR200C20-03R020-N	20	2	3	14	21.5	19.6	45°	C20	XP6305	20,100
7830376	PXDR200C20-03R030-N		3								20,100

Phoenix PXM

スクエア形状

Square Type

PXSH

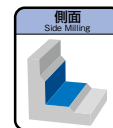

Specification

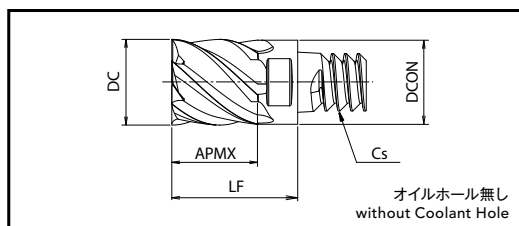

オイルホール無し without Coolant Hole

PXSH 不等分割 多刃 スクエア形状 Unequal Spacing, Multiple Flutes, Square Type

単位:mm Unit:mm

ツールNo. EDP No.	呼び Designation	外径 DC	刃数 Z/F/P	刃長 APMX	全長 LF	首径 DCON	ねじれ角 FHA	締結規格 Cs	材種 Grades	標準価格 (Yen)
NEW 7830380	PXSH120C12-06R000	12	6	12	18	11.7	43°	C12	XP6703	15,100
NEW 7830381	PXSH160C16-06R000	16	6	16	23.5	15.7	43°	C16	XP6703	24,100
NEW 7830382	PXSH200C20-06R000	20	6	20	27.5	19.6	43°	C20	XP6703	30,000
NEW 7830383	PXSH250C25-08R000	25	8	25	35	24	43°	C25	XP6703	45,200

Phoenix PXM

ラジラス形状

Radius Type

PXHF-AM

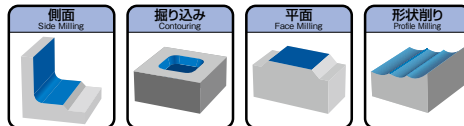

Specification

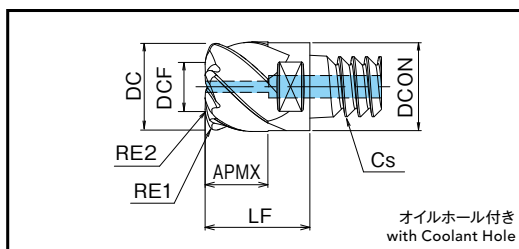

オイルホール付き with Coolant Hole

PXHF-AM 多刃 高送りラジラス形状 Multiple Flutes, High Feed Radius Type

ツールNo. EDP No.	呼び Designation	外径 DC	擬似R rt	有効径 DCF	刃数 ZEP	コーナR RE1	底刃R RE2	刃長 APMX	全長 LF	首径 DCON	ねじれ角 FHA	締結規格 Cs	材種 Grades	標準価格 (Yen)
NEW 7830377	PXHF-AM120C12-06R150-O	12	1.5	6	6	1.2	7	8.4	14.4	11.7	45°	C12	XP6703	16,300
NEW 7830378	PXHF-AM160C16-06R200-O	16	2	8		1.6	9.5	11.2	18.7	15.7	45°	C16	XP6703	22,700
NEW 7830379	PXHF-AM200C20-06R250-O	20	2.5	10		2	12	14	21.5	19.6	45°	C20	XP6703	29,500

1. 内部給油をご利用の際は、オイルホール付きのヘッドとシャンクホルダをご使用下さい。シャンクホルダについてはp.264・p.266をご覧ください。

1. For the use of internal coolant, please use the appropriate head and shank holders with oil hole. Refer to pages 264 and 266 for details on shank holders.

・コーナR部詳細 Details of corner R

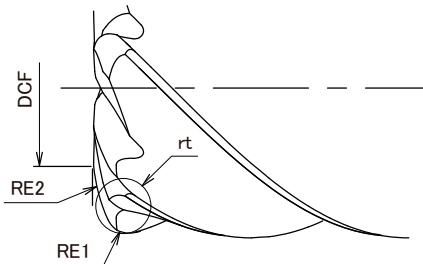

Phoenix PXM

ボール形状

Ball Type

PXBE

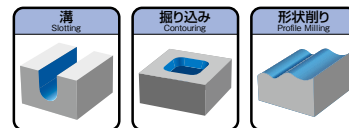

Specification

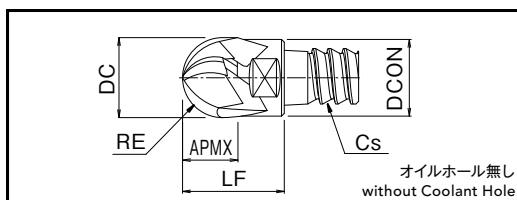

オイルホール無し without Coolant Hole

PXBE-P 3枚刃 能力型 ボール形状 Three Flutes, Multi-purpose, Ball Type

単位:mm Unit:mm

ツールNo. EDP No.	呼び Designation	外径 DC	ボール半径 RE	刃数 ZFP	刃長 APMX	全長 LF	首径 DCON	ねじれ角 FHA	締結規格 Cs	材種 Grades	標準価格 (Yen)
7830270	PXBE100C10-03R050-P	10	5	3	7	13	9.7	45°	C10	XP3320	12,700
7830271	PXBE120C12-03R060-P	12	6	3	8.4	14.4	11.7	45°	C12	XP3320	13,300
7830272	PXBE160C16-03R080-P	16	8	3	11.2	18.7	15.7	45°	C16	XP3320	20,400
7830273	PXBE200C20-03R100-P	20	10	3	14	21.5	19.6	45°	C20	XP3320	24,100

PXBE-N 3枚刃 耐久型 ボール形状 Three Flutes, Heavy-duty, Ball Type

単位:mm Unit:mm

ツールNo. EDP No.	呼び Designation	外径 DC	ボール半径 RE	刃数 ZFP	刃長 APMX	全長 LF	首径 DCON	ねじれ角 FHA	締結規格 Cs	材種 Grades	標準価格 (Yen)
7830250	PXBE100C10-03R050-N	10	5	3	7	13	9.7	45°	C10	XP3320	12,700
7830251	PXBE120C12-03R060-N	12	6	3	8.4	14.4	11.7	45°	C12	XP3320	13,300
7830252	PXBE160C16-03R080-N	16	8	3	11.2	18.7	15.7	45°	C16	XP3320	20,400
7830253	PXBE200C20-03R100-N	20	10	3	14	21.5	19.6	45°	C20	XP3320	24,100

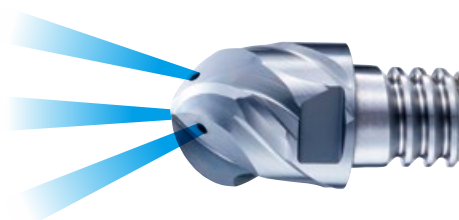
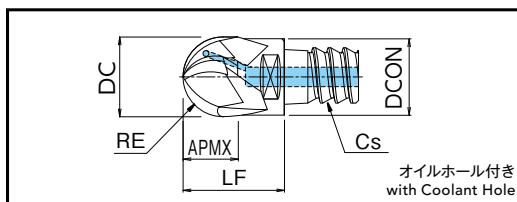

オイルホール付き with Coolant Hole

PXBE-P 3枚刃 能力型 ボール形状 Three Flutes, Multi-purpose, Ball Type

単位:mm Unit:mm

ツールNo. EDP No.	呼び Designation	外径 DC	ボール半径 RE	刃数 ZFP	刃長 APMX	全長 LF	首径 DCON	ねじれ角 FHA	締結規格 Cs	材種 Grades	標準価格 (Yen)
7830281	PXBE120C12-03R060-P-O	12	6	3	8.4	14.4	11.7	45°	C12	XP3320	15,900
7830282	PXBE160C16-03R080-P-O	16	8	3	11.2	18.7	15.7	45°	C16	XP3320	24,700
7830283	PXBE200C20-03R100-P-O	20	10	3	14	21.5	19.6	45°	C20	XP3320	28,900

1. 内部給油をご利用の際は、オイルホール付きのヘッドとシャンクホルダをご使用下さい。シャンクホルダについてはp.264・p.266をご覧ください。

1. For the use of internal coolant, please use the appropriate head and shank holders with oil hole. Refer to pages 264 and 266 for details on shank holders.

PXBE-N 3枚刃 耐久型 ボール形状 Three Flutes, Heavy-duty, Ball Type

単位:mm Unit:mm

ツールNo. EDP No.	呼び Designation	外径 DC	ボール半径 RE	刃数 ZFP	刃長 APMX	全長 LF	首径 DCON	ねじれ角 FHA	締結規格 Cs	材種 Grades	標準価格 (Yen)
7830261	PXBE120C12-03R060-N-O	12	6	3	8.4	14.4	11.7	45°	C12	XP3320	15,900
7830262	PXBE160C16-03R080-N-O	16	8	3	11.2	18.7	15.7	45°	C16	XP3320	24,700
7830263	PXBE200C20-03R100-N-O	20	10	3	14	21.5	19.6	45°	C20	XP3320	28,900

1. 内部給油をご利用の際は、オイルホール付きのヘッドとシャンクホルダをご使用下さい。シャンクホルダについてはp.264・p.266をご覧ください。

1. For the use of internal coolant, please use the appropriate head and shank holders with oil hole. Refer to pages 264 and 266 for details on shank holders.

Phoenix PXM

ボール形状

Ball Type

PXBM

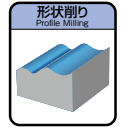

Specification

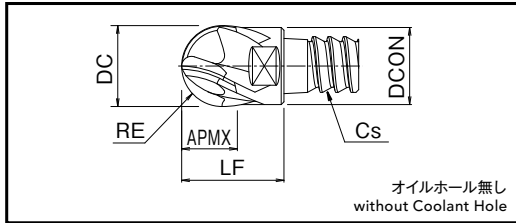

オイルホール無し without Coolant Hole

PXBM 多刃 ボール形状 Multiple Flutes, Ball Type

単位:mm Unit:mm

ツールNo. EDP No.	呼び Designation	外径 DC	ボール半径 RE	刃数 ZFP	刃長 APMX	全長 LF	首径 DCON	ねじれ角 FHA	締結規格 Cs	材種 Grades	標準価格 (Yen)
7830300	PXBM100C10-04R050	10	5	4	7	13	9.7	45°	C10	XP3320	12,700
7830301	PXBM120C12-04R060	12	6	4	8.4	14.4	11.7	45°	C12	XP3320	13,300
7830302	PXBM160C16-06R080	16	8	6	11.2	18.7	15.7	45°	C16	XP3320	20,400
7830303	PXBM200C20-06R100	20	10	6	14	21.5	19.6	45°	C20	XP3320	24,100

Phoenix PXM

PXM用 ストレートシャンクホルダ

Straight Shank Holder for PXM

PXMZ

Specification

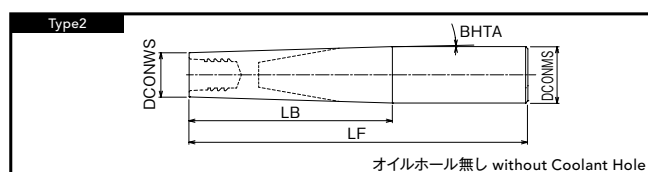
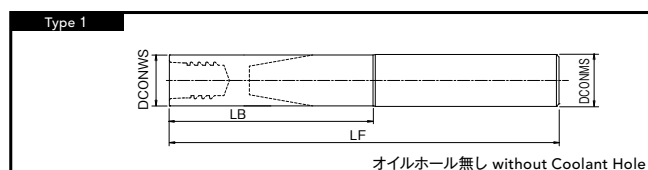

オイルホール無し without Coolant Hole

超硬シャンク Carbide Shank

単位:mm Unit:mm

ツールNo. EDP No.	呼び Designation	首径 DCONWS	シャンク径 DCONMS	角度 BHTA	全長 LF	首下長 LB	ヘッド取付時の有効長 Head + LB			締結規格 Cs	形状 Type	標準価格 (Yen)
							PXVC、 PXAL、 PXSH以外 Except PXVC、 PXAL、PXSH	PXVC、PXAL、PXSH外径 DC φ10、12、16、 20、25、32	φ12、14、18、 22 (刃太タイプ) Reduced Shank Type			
7801830	PXMZ-C10SS10-S075CS	9.8	10	0°	75	17.3	30.3	33.3	35.3	C10	1	31,100
7801810	PXMZ-C10SS10-L100CS		10	0°	100	37.3	50.3	53.3	55.3		1	34,000
7801840	PXMZ-C10TP12-LL130CS		12	0.9°	130	67	80	83	85		2	49,500
7801831	PXMZ-C12SS12-S075CS	11.7	12	0°	75	24	38.4	42	44	C12	1	38,800
7801811	PXMZ-C12SS12-L100CS		12	0°	100	45.9	60.3	63.9	65.9		1	43,300
7801832	PXMZ-C12SS12-L115CS		12	0°	115	64.2	78.6	82.2	84.2		1	49,500
7801841	PXMZ-C12TP16-LL135CS		16	1.3°	135	83.8	98.2	101.8	103.8		2	75,200
7801833	PXMZ-C16SS16-S090CS	15.7	16	0°	90	39.2	57.9	62.7	64.7	C16	1	53,400
7801812	PXMZ-C16SS16-L130CS		16	0°	130	61.2	79.9	84.7	86.7		1	66,600
7801834	PXMZ-C16SS16-L135CS		16	0°	135	84.2	102.9	107.7	109.7		1	67,900
7801842	PXMZ-C16TP20-LL165CS		20	1.1°	165	115	136.5	138.5	140.5		2	102,000
7801835	PXMZ-C20SS20-S090CS	19.6	20	0°	90	39.1	60.6	66.6	68.6	C20	1	65,200
7801813	PXMZ-C20SS20-L150CS		20	0°	150	78.4	99.9	105.9	107.9		1	96,800
7801836	PXMZ-C20SS20-L180CS		20	0°	180	109.1	130.6	136.6	138.6		1	98,900
7801843	PXMZ-C20TP25-LL200CS		25	1.1°	200	140	161.5	167.5	169.5		2	126,000
7801814	PXMZ-C25SS25-L200CS	24	25	0°	200	96.6	124.1	131.6	—	C25	1	128,000
7801815	PXMZ-C32SS32-L250CS	28	32	0°	250	115.2	—	159.9	—	C32	1	240,000

1. 切りくずのかみ込みが起らないようクーラントノズル位置を調整下さい。

1. Adjust the position of the coolant nozzles accordingly so that the chips do not get tangled.

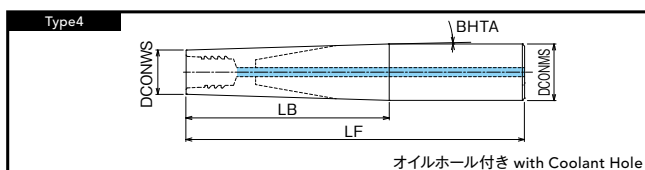
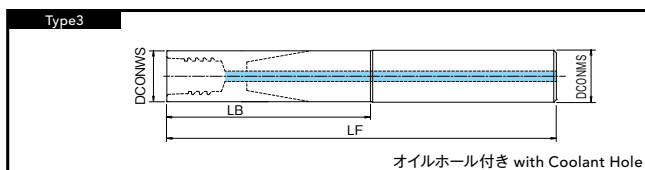

オイルホール付き with Coolant Hole

超硬シャンク Carbide Shank

単位:mm Unit:mm

ツールNo. EDP No.	呼び Designation	首径 DCONWS	シャンク径 DCONMS	角度 BHTA	全長 LF	首下長 LB	ヘッド取付時の有効長 Head + LB			締結規格 Cs	形状 Type	標準価格 (Yen)
							PXVC, PXAL, PXSH以外 Except PXVC, PXAL, PXSH	PXVC, PXAL, PXSH 外径 DC				
								φ12, 16, 20, 25	φ14, 18, 22			
7803511	PXMZ-C12SS12-S075CS-O	11.7	12	0°	75	25	39.4	43	45	C12	3	38,800
7803512	PXMZ-C12SS12-L100CS-O		12	0°	100	46.3	60.7	64.3	66.3		3	43,300
7803513	PXMZ-C12SS12-L115CS-O		12	0°	115	65	79.4	83	85		3	49,500
7803514	PXMZ-C12TP16-LL135CS-O		16	1.3°	135	85	99.4	103	105		4	75,200
7803515	PXMZ-C12TP16-LL150CS-O		16	1°	150	85.6	100	103.6	105.6		4	76,400
7803521	PXMZ-C16SS16-S090CS-O	15.7	16	0°	90	40	58.7	63.5	65.5	C16	3	53,400
7803522	PXMZ-C16SS16-L130CS-O		16	0°	130	62	80.7	85.5	87.5		3	66,600
7803523	PXMZ-C16SS16-L135CS-O		16	0°	135	85	103.7	108.5	110.5		3	67,900
7803524	PXMZ-C16TP20-LL165CS-O		20	1°	165	115	133.7	138.5	140.5		4	102,000
7803525	PXMZ-C16TP20-LL180CS-O		20	1°	180	116.6	135.3	140.1	142.1		4	104,000
7803531	PXMZ-C20SS20-S090CS-O	19.6	20	0°	90	40	61.5	67.5	69.5	C20	3	65,200
7803532	PXMZ-C20SS20-L150CS-O		20	0°	150	79.3	100.8	106.8	108.8		3	96,800
7803533	PXMZ-C20SS20-L180CS-O		20	0°	180	110	131.5	137.5	139.5		3	98,900
7803534	PXMZ-C20TP25-LL200CS-O		25	1°	200	140	161.5	167.5	169.5		4	126,000
7803535	PXMZ-C20TP25-LL210CS-O		25	1°	210	145	166.5	172.5	174.5		4	128,000
7803541	PXMZ-C25SS25-L200CS-O	24	25	0°	200	98	125.5	133	-	C25	3	128,000

- 内部給油をご利用の際は、オイルホール付きのヘッドとシャンクホルダをご使用下さい。
但し、PXVCをはじめオイルホール非対応のヘッドでも、オイルホール付きシャンクホルダに取り付けて加工可能です。
2. 切りくずのかみ込みが起らないようクーラントノズル位置を調整下さい。
- For the use of internal coolant, please use the appropriate head and shank holders with oil hole.
Shank holders with oil hole can also be used with heads without oil hole such as PXVC in case of dry machining or external coolant.
- Adjust the position of the coolant nozzles accordingly so that the chips do not get tangled.

Phoenix PXM

PXM用 ストレートシャンクホルダ

Straight Shank Holder for PXM

PXMZ

Specification

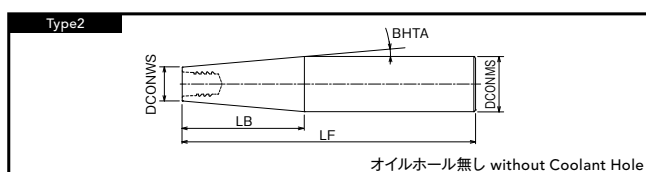
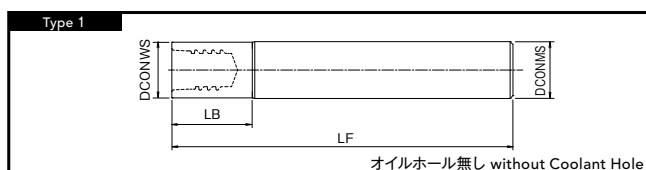

オイルホール無し without Coolant Hole

鋼シャンク Steel Shank

単位:mm Unit:mm

ツールNo. EDP No.	呼び Designation	首径 DCONWS	シャンク径 DCONMS	角度 BHTA	全長 LF	首下長 LB	ヘッド取付時の有効長 Head + LB			締結規格 Cs	形状 Type	標準価格 (Yen)
							PXVC、 PXAL、 PXSH以外 Except PXVC、 PXAL、PXSH	PXVC、PXAL、PXSH外径 DC				
								φ10、12、16、 20、25、32	φ12、14、18、 22 (刃太タイプ) Reduced Shank Type			
7801800	PXMZ-C10SS10-S075	9.8	10	0°	75	12	25	28	30	C10	1	10,300
7801801	PXMZ-C12SS12-S100	11.7	12	0°	100	18	32.4	36	38	C12	1	14,100
7801821	PXMZ-C12TP20-S145		20	5°	145	47.4	61.8	65.4	67.4		2	16,500
7801802	PXMZ-C16SS16-S100	15.7	16	0°	100	23	41.7	46.5	48.5	C16	1	14,300
7801822	PXMZ-C16TP25-S155		25	5°	155	53.1	71.8	76.6	78.6		2	19,800
7801803	PXMZ-C20SS20-S120	19.6	20	0°	120	28	49.5	55.5	57.5	C20	1	16,700
7801823	PXMZ-C20TP32-S170		32	5°	170	70.8	92.3	98.3	100.3		2	23,600
7801804	PXMZ-C25SS25-S140	24	25	0°	140	34.5	62	69.5	—	C25	1	17,600
7801805	PXMZ-C32SS32-S160	28	32	0°	160	33	—	77.7	—	C32	1	21,300

1. 切りくずのかみ込みが起こらないようクーラントノズル位置を調整下さい。

1. Adjust the position of the coolant nozzles accordingly so that the chips do not get tangled.

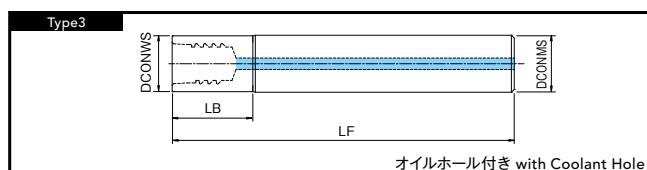

オイルホール付き with Coolant Hole

鋼シャンク Steel Shank

単位:mm Unit:mm

ツールNo. EDP No.	呼び Designation	首径 DCONWS	シャンク径 DCONMS	角度 BHTA	全長 LF	首下長 LB	ヘッド取付時の有効長 Head + LB			締結規格 Cs	形状 Type	標準価格 (Yen)
							PXVC, PXAL, PXSH以外 Except PXVC, PXAL, PXSH	PXVC, PXAL, PXSH外径 DC				
								φ12, 16, 20, 25	φ14, 18, 22			
7803501	PXMZ-C12SS12-S100-O	11.7	12	0°	100	18	32.4	36	38	C12	3	14,100
7803502	PXMZ-C16SS16-S100-O	15.7	16	0°	100	23	41.7	46.5	48.5	C16	3	14,300
7803503	PXMZ-C20SS20-S120-O	19.6	20	0°	120	28	49.5	55.5	57.5	C20	3	16,700
7803504	PXMZ-C25SS25-S140-O	24	25	0°	140	34.5	62	69.5	—	C25	3	17,600

- 内部給油をご利用の際は、オイルホール付きのヘッドとシャンクホルダをご使用下さい。
但し、PXVCをはじめオイルホール非対応のヘッドでも、オイルホール付きシャンクホルダに取り付けて加工可能です。
- 切りくずのかみ込みが起らないようクーラントノズル位置を調整下さい。
- For the use of internal coolant, please use the appropriate head and shank holders with oil hole.
Shank holders with oil hole can also be used with heads without oil hole such as PXVC in case of dry machining or external coolant.
- Adjust the position of the coolant nozzles accordingly so that the chips do not get tangled.

Phoenix PXM

PXM用ジョイント

Joint for PXM

PXMJ

Specification

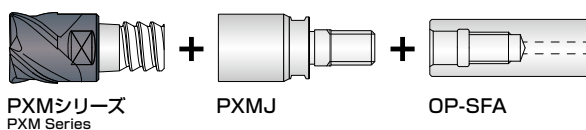
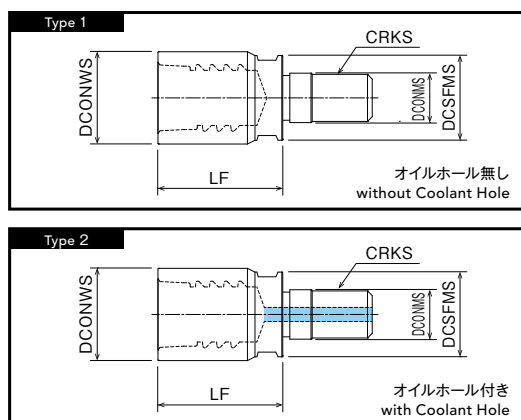

お手持ちのシャンクホルダ(OP-SFA)にPXMJを組み合わせる事により、PXMシリーズの使用が可能となります。
PXM series can be used with the shank holder (OP-SFA) by connecting the joint holder (PXMJ).

オイルホール無し without Coolant Hole

PXMJ ジョイント Joint

単位:mm Unit:mm

ツールNo. EDP No.	呼び Designation	適用ヘッド外径 Applicable Head Dia.	めねじ側 端面径 DCONWS	おねじ側 取付け径 DCONMS	おねじ サイズ CRKS	適用 スパナ Spanner	全長 LF	おねじ側 端面径 DCSEFMS	締結規格 Cs	形状 Type	標準価格 (Yen)
7801893	PXMJ-C12SF06	12	11.7	6.5	M 6	PXMP8-10	18	11	C12	1	9,920
7801894	PXMJ-C16SF08	16	15.7	8.5	M 8	PXMP13-16	21.8	14.5	C16	1	12,700
7801895	PXMJ-C20SF10	20	19.6	10.5	M10	PXMP13-16	26.5	18	C20	1	14,100
7801896	PXMJ-C25SF12	25	24	12.5	M12	PXMP21	34	23	C25	1	16,100

オイルホール付き with Coolant Hole

PXMJ ジョイント Joint

単位:mm Unit:mm

ツールNo. EDP No.	呼び Designation	適用ヘッド外径 Applicable Head Dia.	めねじ側 端面径 DCONWS	おねじ側 取付け径 DCONMS	おねじ サイズ CRKS	適用 スパナ Spanner	全長 LF	おねじ側 端面径 DCSEFMS	締結規格 Cs	形状 Type	標準価格 (Yen)
7803551	PXMJ-C12SF06-O	12	11.7	6.5	M 6	PXMP8-10	18	11	C12	2	9,920
7803552	PXMJ-C16SF08-O	16	15.7	8.5	M 8	PXMP13-16	21.8	14.5	C16	2	12,700
7803553	PXMJ-C20SF10-O	20	19.6	10.5	M10	PXMP13-16	26.5	18	C20	2	14,100
7803554	PXMJ-C25SF12-O	25	24	12.5	M12	PXMP21	34	23	C25	2	16,100

- 内部給油をご利用の際は、オイルホール付きのヘッドとシャンクホルダをご使用下さい。シャンクホルダについてはp.264・p.266をご覧ください。
- For the use of internal coolant, please use the appropriate head and shank holders with oil hole. Refer to pages 264 and 266 for details on shank holders.

Accessories

■部品 Accessories

	ツールNo. EDP No.	呼び Designation	適用ヘッド外径 Applicable Head Dia.	締結規格 Cs	推奨締付けトルク Recommended Tightening Torque	標準価格 (Yen)
スパナ Spanner	7801890	PXMP8-10	φ10, φ12(刃太タイプ)	C10	10N・m	1,110
			φ12, φ14	C12	12N・m	
	7801891	PXMP13-16	φ16, φ18	C16	30N・m	1,670
			φ20, φ22	C20	50N・m	
7801892	PXMP21		φ25	C25	60N・m	1,740
7801897	PXMP24		φ32	C32	60N・m	2,140

PXM専用のスパナとなります。スパナは別途ご購入下さい。

These spanner are specifically for PXM, and sold separately from the cutters.

- 使用上の注意はp.294をご覧ください。
- 締付けトルクは上表を参照下さい。
- 締付けトルク管理のための専用トルクレンチについては当社営業までお問い合わせ下さい。
- Please refer to p.294 for cautions during use.
- Please refer to the table above for tightening torque.
- Contact your nearest OSG sales representative for details of our dedicated adjustable torque wrench for tightening inserts.

Phoenix PXM

スクエア・コーナラジアス形状

Square · Corner Radius Type

PXSE

Cutting Conditions

■ 切削条件基準表 Cutting Conditions

PXSE 側面切削 Side Milling $L/D \leq 3.5$

被削材 Work Material	一般構造用鋼・炭素鋼・鋳鉄 Mild Steel · Carbon Steel · Cast Iron SS400, S55C, FC250 (~750N/mm ²)		合金鋼・工具鋼 Alloy Steel Tool Steel SCM, SKT, SKS, SKD (~30HRC)		ステンレス鋼・調質鋼 Stainless Steel Hardened Steel SUS304, SKD (~45HRC)		調質鋼・チタン合金(湿式) Hardened Steel Titanium Alloy (Wet) Ti-6Al-4V (45 ~ 55HRC)		超耐熱合金(湿式) インコネル 718 Superalloy (Wet) Inconel 718	
	外径 DC	回転速度 Speed (min ⁻¹)	送り速度 Feed (mm/min)	回転速度 Speed (min ⁻¹)	送り速度 Feed (mm/min)	回転速度 Speed (min ⁻¹)	送り速度 Feed (mm/min)	回転速度 Speed (min ⁻¹)	送り速度 Feed (mm/min)	回転速度 Speed (min ⁻¹)
10	3,810	920	3,190	770	2,070	500	2,070	420	800	130
12	3,190	770	2,660	640	1,730	420	1,730	350	670	110
16	2,390	580	1,990	480	1,300	320	1,300	260	500	80
20	1,910	460	1,600	390	1,040	250	1,040	210	400	70
25	1,530	370	1,280	310	830	200	830	170	320	60
切込深さ Depth of Cut	ap=0.5DC ae=0.15DC				ap=0.5DC ae=0.1DC		ap=0.5DC ae=0.05DC		ap=0.5DC ae=0.05DC	

PXSE 溝切削 Slot Milling $L/D \leq 3.5$

被削材 Work Material	一般構造用鋼・炭素鋼・鋳鉄 Mild Steel · Carbon Steel · Cast Iron SS400, S55C, FC250 (~750N/mm ²)		合金鋼・工具鋼 Alloy Steel Tool Steel SCM, SKT, SKS, SKD (~30HRC)		ステンレス鋼・調質鋼 Stainless Steel Hardened Steel SUS304, SKD (~45HRC)		調質鋼・チタン合金(湿式) Hardened Steel Titanium Alloy (Wet) Ti-6Al-4V (45 ~ 55HRC)		超耐熱合金(湿式) インコネル 718 Superalloy (Wet) Inconel 718	
	外径 DC	回転速度 Speed (min ⁻¹)	送り速度 Feed (mm/min)	回転速度 Speed (min ⁻¹)	送り速度 Feed (mm/min)	回転速度 Speed (min ⁻¹)	送り速度 Feed (mm/min)	回転速度 Speed (min ⁻¹)	送り速度 Feed (mm/min)	回転速度 Speed (min ⁻¹)
10	3,030	610	3,030	610	1,600	320	1,600	260	800	130
12	2,520	510	2,520	510	1,330	270	1,330	220	670	110
16	1,890	380	1,890	380	1,000	200	1,000	160	500	80
20	1,520	310	1,520	310	800	160	800	130	400	70
25	1,210	250	1,210	250	640	130	640	110	320	60
切込深さ Depth of Cut	ap ≤ 0.35DC				ap ≤ 0.3DC		ap ≤ 0.2DC		ap ≤ 0.1DC	

1. 機械、ホルダは剛性のある精度の高いものをご使用下さい。
 2. 切込深さ、機械剛性等使用状況により、回転速度、送り速度を調整下さい。
 3. 突出し量が長くなる場合は、びびりが発生しやすくなりますので、回転速度、送り速度、切込深さを調整下さい。
 4. 切削条件は、ホルダ端面からのシャンクホルダ(PXMZ)の突出し長さにはヘッド全長(LF)を加えた突出し長さを配慮した選定をして下さい。
1. Use a rigid and precise machine and holder.
 2. Please adjust the speed and feed when the depth of cut is large or when machines with low rigidity are used.
 3. Please adjust the cutting condition when the overhang length is longer.
 4. Please consider the overhang length as the total length of replaceable head and overhang length of shank holder.

Phoenix PXM

スクエア・コーナラジラス形状

Square - Corner Radius Type

PXVC

Cutting Conditions

■ 切削条件基準表 Cutting Conditions

ヘッド交換式エンドミル PXVC 側面切削 Side Milling $L/D \leq 5$

被削材 Work Material	一般構造用鋼・炭素鋼・鋳鉄 Mild Steel・Carbon Steel Cast Iron SS400, S55C, FC250 (~750N/mm ²)		合金鋼・工具鋼 Alloy Steel Tool Steel SCM, SKT, SKS, SKD (~30HRC)		ステンレス鋼・調質鋼 Stainless Steel Hardened Steel SUS304, SKD (~45HRC)		調質鋼・チタン合金(湿式) Hardened Steel Titanium Alloy (Wet) Ti-6Al-4V (45~55HRC)	
	外径 DC	回転速度 Speed (min ⁻¹)	送り速度 Feed (mm/min)	回転速度 Speed (min ⁻¹)	送り速度 Feed (mm/min)	回転速度 Speed (min ⁻¹)	送り速度 Feed (mm/min)	回転速度 Speed (min ⁻¹)
10	4,780	1,150	3,820	920	3,190	770	2,550	620
12	3,980	960	3,190	770	2,660	640	2,130	520
14	3,420	830	2,730	660	2,280	550	1,820	440
16	2,990	720	2,390	580	1,990	480	1,600	390
18	2,660	640	2,130	520	1,770	430	1,420	350
20	2,390	580	1,910	460	1,600	390	1,280	310
22	2,180	530	1,740	420	1,450	350	1,160	280
25	1,910	460	1,530	370	1,280	310	1,020	250
32-5F	1,500	380	1,200	240	1,000	250	800	160
32-8F	1,500	480	1,200	390	1,000	320	800	260
切込深さ Depth of Cut	ap=0.5DC ae=0.2DC				ap=0.5DC ae=0.1DC		ap=0.5DC ae=0.05DC	

ヘッド交換式エンドミル PXVC 側面切削 Side Milling $5 < L/D \leq 6$

被削材 Work Material	一般構造用鋼・炭素鋼・鋳鉄 Mild Steel・Carbon Steel Cast Iron SS400, S55C, FC250 (~750N/mm ²)		合金鋼・工具鋼 Alloy Steel Tool Steel SCM, SKT, SKS, SKD (~30HRC)		ステンレス鋼・調質鋼 Stainless Steel Hardened Steel SUS304, SKD (~45HRC)		調質鋼・チタン合金(湿式) Hardened Steel Titanium Alloy (Wet) Ti-6Al-4V (45~55HRC)	
	外径 DC	回転速度 Speed (min ⁻¹)	送り速度 Feed (mm/min)	回転速度 Speed (min ⁻¹)	送り速度 Feed (mm/min)	回転速度 Speed (min ⁻¹)	送り速度 Feed (mm/min)	回転速度 Speed (min ⁻¹)
10	4,300	1,040	3,510	850	2,870	690	2,230	540
12	3,590	870	2,920	710	2,390	580	1,860	450
14	3,070	740	2,510	610	2,050	500	1,600	390
16	2,690	650	2,190	530	1,800	440	1,400	340
18	2,390	580	1,950	470	1,600	390	1,240	300
20	2,150	520	1,760	430	1,440	350	1,120	270
22	1,960	480	1,600	390	1,310	320	1,020	250
25	1,720	420	1,410	340	1,150	280	900	220
32	標準シャンクとの組合せでは、最長でもL/D=5までとなります Maximum length of L/D=5 in combination with the standard shank							
切込深さ Depth of Cut	ap=0.5DC ae=0.2DC				ap=0.5DC ae=0.1DC		ap=0.5DC ae=0.05DC	

1. 機械、ホルダは剛性のある精度の高いものをご使用下さい。
 2. 切込深さ、機械剛性等使用状況により、回転速度、送り速度を調整下さい。
 3. 突出し量が増える場合は、びびりが発生しやすくなりますので、回転速度、送り速度、切込深さを調整下さい。
 4. 切削条件は、ホルダ端面からのシャンクホルダ(PXMZ)の突出し長さによりヘッド全長(LF)を加えた突出し長さを配慮した選定をして下さい。
1. Use a rigid and precise machine and holder.
 2. Please adjust the speed and feed when the depth of cut is large or when machines with low rigidity are used.
 3. Please adjust the cutting condition when the overhang length is longer.
 4. Please consider the overhang length as the total length of replaceable head and overhang length of shank holder.

ヘッド交換式エンドミル PXVC 側面切削 Side Milling $6 < L/D \leq 7$

被削材 Work Material	一般構造用鋼・炭素鋼・鋳鉄 Mild Steel・Carbon Steel Cast Iron SS400, S55C, FC250 (~750N/mm ²)		合金鋼・工具鋼 Alloy Steel Tool Steel SCM, SKT, SKS, SKD (~30HRC)		ステンレス鋼・調質鋼 Stainless Steel Hardened Steel SUS304, SKD (~45HRC)		調質鋼・チタン合金(湿式) Hardened Steel Titanium Alloy (Wet) Ti-6Al-4V (45~55HRC)	
	外径 DC	回転速度 Speed (min ⁻¹)	送り速度 Feed (mm/min)	回転速度 Speed (min ⁻¹)	送り速度 Feed (mm/min)	回転速度 Speed (min ⁻¹)	送り速度 Feed (mm/min)	回転速度 Speed (min ⁻¹)
10	3,820	920	3,190	770	2,550	620	1,910	460
12	3,190	770	2,660	640	2,130	520	1,600	390
14	2,730	660	2,280	550	1,820	440	1,370	330
16	2,390	580	1,990	480	1,600	390	1,200	290
18	2,130	520	1,770	430	1,420	350	1,070	260
20	1,910	460	1,600	390	1,280	310	960	240
22	1,740	420	1,450	350	1,160	280	870	210
25	1,530	370	1,280	310	1,020	250	770	190
32	標準シャンクとの組合せでは、最長でもL/D=5までとなります Maximum length of L/D=5 in combination with the standard shank							
切込深さ Depth of Cut	ap=0.5DC ae=0.2DC		ap=0.5DC ae=0.1DC		ap=0.5DC ae=0.1DC		ap=0.5DC ae=0.05DC	

1. 機械、ホルダは剛性のある精度の高いものをご使用下さい。
 2. 切込深さ、機械剛性等使用状況により、回転速度、送り速度を調整下さい。
 3. 突出し量が長くなる場合は、びびりが発生しやすくなりますので、回転速度、送り速度、切込深さを調整下さい。
 4. 切削条件は、ホルダ端面からのシャンクホルダ(PXMZ)の突出し長さへヘッド全長(LF)を加えた突出し長さを配慮した選定して下さい。
1. Use a rigid and precise machine and holder.
 2. Please adjust the speed and feed when the depth of cut is large or when machines with low rigidity are used.
 3. Please adjust the cutting condition when the overhang length is longer.
 4. Please consider the overhang length as the total length of replaceable head and overhang length of shank holder.

Phoenix PXM

スクエア・コーナラジラス形状

Square - Corner Radius Type

PXVC

Cutting Conditions

■ 切削条件基準表 Cutting Conditions

ヘッド交換式エンドミル PXVC 溝切削 Slot Milling L/D ≤ 5

被削材 Work Material	一般構造用鋼・炭素鋼・鋳鉄 Mild Steel・Carbon Steel Cast Iron SS400, S55C, FC250 (~750N/mm ²)		合金鋼・工具鋼 Alloy Steel Tool Steel SCM, SKT, SKS, SKD (~30HRC)		ステンレス鋼・調質鋼 Stainless Steel Hardened Steel SUS304, SKD (~45HRC)		調質鋼・チタン合金(湿式) Hardened Steel Titanium Alloy (Wet) Ti-6Al-4V (45 ~ 55HRC)	
	外径 DC	回転速度 Speed (min ⁻¹)	送り速度 Feed (mm/min)	回転速度 Speed (min ⁻¹)	送り速度 Feed (mm/min)	回転速度 Speed (min ⁻¹)	送り速度 Feed (mm/min)	回転速度 Speed (min ⁻¹)
10	4,780	960	3,820	770	3,180	640	2,390	480
12	3,980	800	3,180	640	2,650	530	1,990	400
14	3,410	680	2,730	550	2,270	450	1,710	340
16	2,980	600	2,390	480	1,990	400	1,490	300
18	2,650	530	2,120	420	1,770	350	1,330	270
20	2,390	480	1,910	380	1,590	320	1,190	240
22	2,170	430	1,740	350	1,450	290	1,090	220
25	1,910	380	1,530	310	1,270	250	950	190
32	非推奨(刃数が多いため) Not recommended (due to the large number of flutes)							
切込深さ Depth of Cut	ap ≤ 0.5DC		ap ≤ 0.4DC		ap ≤ 0.3DC			

ヘッド交換式エンドミル PXVC 溝切削 Slot Milling 5 < L/D ≤ 6

被削材 Work Material	一般構造用鋼・炭素鋼・鋳鉄 Mild Steel・Carbon Steel Cast Iron SS400, S55C, FC250 (~750N/mm ²)		合金鋼・工具鋼 Alloy Steel Tool Steel SCM, SKT, SKS, SKD (~30HRC)		ステンレス鋼・調質鋼 Stainless Steel Hardened Steel SUS304, SKD (~45HRC)		調質鋼・チタン合金(湿式) Hardened Steel Titanium Alloy (Wet) Ti-6Al-4V (45 ~ 55HRC)	
	外径 DC	回転速度 Speed (min ⁻¹)	送り速度 Feed (mm/min)	回転速度 Speed (min ⁻¹)	送り速度 Feed (mm/min)	回転速度 Speed (min ⁻¹)	送り速度 Feed (mm/min)	回転速度 Speed (min ⁻¹)
10	3,820	770	3,190	640	2,550	510	2,070	420
12	3,190	640	2,660	540	2,130	430	1,730	350
14	2,730	550	2,280	460	1,820	370	1,480	300
16	2,390	480	1,990	400	1,600	320	1,300	260
18	2,130	430	1,770	360	1,420	290	1,150	230
20	1,910	390	1,600	320	1,280	260	1,040	210
22	1,740	350	1,450	290	1,160	240	950	190
25	1,530	310	1,280	260	1,020	210	830	170
32	標準シャンクとの組合せでは、最長でもL/D=5までとなります Maximum length of L/D=5 in combination with the standard shank							
切込深さ Depth of Cut	ap ≤ 0.5DC		ap ≤ 0.4DC		ap ≤ 0.3DC			

1. 機械、ホルダは剛性のある精度の高いものをご使用下さい。
 2. 切込深さ、機械剛性等使用状況により、回転速度、送り速度を調整下さい。
 3. 突出し量が増える場合は、びびりが発生しやすくなりますので、回転速度、送り速度、切込深さを調整下さい。
 4. 切削条件は、ホルダ端面からのシャンクホルダ(PXMZ)の突出し長さ(FL)に加え、ヘッド全長(LF)を加えた突出し長さを配慮した選定をして下さい。
1. Use a rigid and precise machine and holder.
 2. Please adjust the speed and feed when the depth of cut is large or when machines with low rigidity are used.
 3. Please adjust the cutting condition when the overhang length is longer.
 4. Please consider the overhang length as the total length of replaceable head and overhang length of shank holder.

ヘッド交換式エンドミル PXVC 溝切削 Slot Milling $6 < L/D \leq 7$

被削材 Work Material	一般構造用鋼・炭素鋼・鋳鉄 Mild Steel・Carbon Steel Cast Iron SS400, S55C, FC250 (~750N/mm ²)		合金鋼・工具鋼 Alloy Steel Tool Steel SCM, SKT, SKS, SKD (~30HRC)		ステンレス鋼・調質鋼 Stainless Steel Hardened Steel SUS304, SKD (~45HRC)		調質鋼・チタン合金(湿式) Hardened Steel Titanium Alloy (Wet) Ti-6Al-4V (45~55HRC)	
	外径 DC	回転速度 Speed (min ⁻¹)	送り速度 Feed (mm/min)	回転速度 Speed (min ⁻¹)	送り速度 Feed (mm/min)	回転速度 Speed (min ⁻¹)	送り速度 Feed (mm/min)	回転速度 Speed (min ⁻¹)
10	3,190	640	2,550	510	2,230	450	1,910	390
12	2,660	540	2,130	430	1,860	380	1,600	320
14	2,280	460	1,820	370	1,600	320	1,370	280
16	1,990	400	1,600	320	1,400	280	1,200	240
18	1,770	360	1,420	290	1,240	250	1,070	220
20	1,600	320	1,280	260	1,120	230	960	200
22	1,450	290	1,160	240	1,020	210	870	180
25	1,280	260	1,020	210	900	180	770	160
32	標準シャンクとの組合せでは、最長でもL/D=5までとなります Maximum length of L/D=5 in combination with the standard shank							
切込深さ Depth of Cut	$a_p \leq 0.3DC$			$a_p \leq 0.25DC$		$a_p \leq 0.2DC$		

1. 機械、ホルダは剛性のある精度の高いものをご使用下さい。
 2. 切込深さ、機械剛性等使用状況により、回転速度、送り速度を調整下さい。
 3. 突出し量が長くなる場合は、びびりが発生しやすくなりますので、回転速度、送り速度、切込深さを調整下さい。
 4. 切削条件は、ホルダ端面からのシャンクホルダ(PXMZ)の突出し長さへヘッド全長(LF)を加えた突出し長さを配慮した選定をして下さい。
1. Use a rigid and precise machine and holder.
 2. Please adjust the speed and feed when the depth of cut is large or when machines with low rigidity are used.
 3. Please adjust the cutting condition when the overhang length is longer.
 4. Please consider the overhang length as the total length of replaceable head and overhang length of shank holder.

Phoenix PXM

スクエア・コーナラジラス形状

Square - Corner Radius Type

PXSM

Cutting Conditions

■切削条件基準表 Cutting Conditions

PXSM 側面切削 Side Milling L/D ≤ 3.5

被削材 Work Material		一般構造用鋼・炭素鋼・鋳鉄 Mild Steel・Carbon Steel Cast Iron SS400, S55C, FC250 (~750N/mm ²)		合金鋼・工具鋼 Alloy Steel Tool Steel SCM, SKT, SKS, SKD (~30HRC)		ステンレス鋼・調質鋼 Stainless Steel Hardened Steel SUS304, SKD (~45HRC)		調質鋼・チタン合金(湿式) Hardened Steel・ Titanium Alloy (Wet) Ti-6Al-4V (45~55HRC)		超耐熱合金(湿式) インコネル718 Superalloy (Wet) Inconel 718	
外径 DC	刃数 Z/FP	回転速度 Speed (min ⁻¹)	送り速度 Feed (mm/min)	回転速度 Speed (min ⁻¹)	送り速度 Feed (mm/min)	回転速度 Speed (min ⁻¹)	送り速度 Feed (mm/min)	回転速度 Speed (min ⁻¹)	送り速度 Feed (mm/min)	回転速度 Speed (min ⁻¹)	送り速度 Feed (mm/min)
10	6	5,730	2,070	4,780	1,440	3,820	1,150	3,190	960	1,910	420
12	6	4,780	1,730	3,980	1,200	3,190	960	2,660	800	1,600	350
16	6	3,590	1,300	2,990	900	2,390	720	1,990	600	1,200	260
16	8	3,590	1,730	2,990	1,200	2,390	960	1,990	800	1,200	350
20	10	2,870	1,730	2,390	1,200	1,910	960	1,600	800	960	350
25	10	2,300	1,380	1,910	960	1,530	770	1,280	640	770	280
切込深さ Depth of Cut		ap ≤ 0.5DC ae ≤ 0.05DC				ap ≤ 0.5DC ae ≤ 0.02DC		ap ≤ 0.3DC ae ≤ 0.02DC			

1. 機械、ホルダは剛性のある精度の高いものをご使用下さい。
 2. 切込深さ、機械剛性等使用状況により、回転速度、送り速度を調整下さい。
 3. 突出し量が長くなる場合は、びびりが発生しやすくなりますので、回転速度、送り速度、切込深さを調整下さい。
 4. 切削条件は、ホルダ端面からのシャンクホルダ(PXMZ)の突出し長さにヘッド全長(LF)を加えた突出し長さを配慮した選定をして下さい。
1. Use a rigid and precise machine and holder.
 2. Please adjust the speed and feed when the depth of cut is large or when machines with low rigidity are used.
 3. Please adjust the cutting condition when the overhang length is longer.
 4. Please consider the overhang length as the total length of replaceable head and overhang length of shank holder.

Phoenix PXM

スクエア・コーナラジラス形状

Square - Corner Radius Type

PXAL

Cutting Conditions

■ 切削条件基準表 Cutting Conditions

PXAL 側面切削 Side Milling $L/D \leq 3$

被削材 Work Material	アルミニウム合金展伸材 Aluminum Alloy Expanding Material A5052, A7075	
外径 DC	回転速度 Speed (min^{-1})	送り速度 Feed (mm/min)
10	16,000	4,800
12	13,300	3,990
14	11,400	3,420
16	10,000	3,600
18	8,900	3,210
20	8,000	3,840
22	7,300	3,510
25	6,400	3,840
切込深さ Depth of Cut	$a_p=0.7D$ $a_e=0.2D$	

$3 < L/D \leq 5$

被削材 Work Material	アルミニウム合金展伸材 Aluminum Alloy Expanding Material A5052, A7075	
外径 DC	回転速度 Speed (min^{-1})	送り速度 Feed (mm/min)
10	9,600	2,310
12	8,000	1,920
14	6,900	1,660
16	6,000	1,730
18	5,400	1,560
20	4,800	1,850
22	4,400	1,690
25	3,900	1,880
切込深さ Depth of Cut	$a_p=0.7D$ $a_e=0.08D$	

$5 < L/D \leq 7$

被削材 Work Material	アルミニウム合金展伸材 Aluminum Alloy Expanding Material A5052, A7075	
外径 DC	回転速度 Speed (min^{-1})	送り速度 Feed (mm/min)
10	6,400	1,390
12	5,400	1,170
14	4,600	1,000
16	4,000	1,040
18	3,600	940
20	3,200	1,110
22	2,900	1,010
25	2,600	1,130
切込深さ Depth of Cut	$a_p=0.7D$ $a_e=0.04D$	

PXAL 溝切削 Slot Milling $L/D \leq 3$

被削材 Work Material	アルミニウム合金展伸材 Aluminum Alloy Expanding Material A5052, A7075	
外径 DC	回転速度 Speed (min^{-1})	送り速度 Feed (mm/min)
10	16,000	4,800
12	13,300	3,990
14	11,400	3,420
16	10,000	3,000
18	8,900	2,670
20	8,000	2,400
22	7,300	2,190
25	6,400	1,920
切込深さ Depth of Cut	$a_p=0.5D$	

$3 < L/D \leq 5$

被削材 Work Material	アルミニウム合金展伸材 Aluminum Alloy Expanding Material A5052, A7075	
外径 DC	回転速度 Speed (min^{-1})	送り速度 Feed (mm/min)
10	9,600	2,160
12	8,000	1,800
14	6,900	1,560
16	6,000	1,350
18	5,400	1,220
20	4,800	1,080
22	4,400	990
25	3,900	880
切込深さ Depth of Cut	$a_p=0.35D$	

$5 < L/D \leq 7$

被削材 Work Material	アルミニウム合金展伸材 Aluminum Alloy Expanding Material A5052, A7075	
外径 DC	回転速度 Speed (min^{-1})	送り速度 Feed (mm/min)
10	6,400	960
12	5,400	810
14	4,600	690
16	4,000	600
18	3,600	540
20	3,200	480
22	2,900	440
25	2,600	390
切込深さ Depth of Cut	$a_p=0.2D$	

1. 機械、ホルダは剛性のある精度の高いものをご使用下さい。
2. 切込深さ、機械剛性等使用状況により、回転速度、送り速度を調整下さい。
3. 突出し量が増える場合は、びびりが発生しやすくなりますので、回転速度、送り速度、切込深さを調整下さい。
4. 切削条件は、ホルダ端面からのシャンクホルダ(PXMZ)の突出し長さ(ヘッド全長(LF)を加えた突出し長さを配慮した選定をして下さい。
5. 銅・銅合金切削時は、上表の回転速度20~40%、送り速度50~80%、切込深さ(a_p)50~80%程度に下げてください。
6. マグネシウム合金切削時は、アルミニウム合金展伸材と同条件でご使用下さい。切削油剤を使用する場合は切削油剤メーカーの推奨するものを必ずご使用下さい。また、切りくずの処理・管理にご注意下さい。発火の恐れがあります。

1. Use a rigid and precise machine and holder.
2. Please adjust the speed and feed when the depth of cut is large or when machines with low rigidity are used.
3. Please adjust the cutting condition when the overhang length is longer.
4. Please consider the overhang length as the total length of replaceable head and overhang length of shank holder.
5. When milling copper and copper alloys, lower the rotational speed by 20 to 40%, feed rate by 50 to 80%, and cutting depth by a_p 50 to 80% in accordance with the table above.
6. Please always use the appropriate cutting fluid recommended by the cutting fluid manufacturer in the machining of magnesium alloys. Be cautious with the cutting chips as they are highly flammable and may pose a serious fire risk if not properly handled.

Phoenix PXM

ラフィング形状

Roughing Type

PXNH/PXNL

Cutting Conditions

■ 切削条件基準表 Cutting Conditions

PXNH・PXNL 側面切削 Side Milling $L/D \leq 3.5$

被削材 Work Material	鋳鉄 Cast Iron FC250		炭素鋼 Carbon Steel		合金鋼 Alloy Steel		調質鋼・プリハードン鋼(快削) Hardened Steel Pre-hardened Steel (Free-Cutting) (~45HRC)		ステンレス鋼 Stainless Steel SUS304	
	外径 DC	回転速度 Speed (min ⁻¹)	送り速度 Feed (mm/min)	回転速度 Speed (min ⁻¹)	送り速度 Feed (mm/min)	回転速度 Speed (min ⁻¹)	送り速度 Feed (mm/min)	回転速度 Speed (min ⁻¹)	送り速度 Feed (mm/min)	回転速度 Speed (min ⁻¹)
10	2,860	720	3,820	840	3,180	520	2,860	350	2,550	280
12	2,390	600	3,180	700	2,650	440	2,390	290	2,120	230
16	1,790	620	2,390	720	1,990	450	1,790	300	1,590	240
20	1,430	660	1,910	760	1,590	480	1,430	310	1,270	250
25	890	450	1,270	560	1,020	340	890	220	760	170
切込深さ Depth of Cut	ap=0.5DC ae=0.3DC					ap=0.5DC ae=0.2DC				

PXNH・PXNL 溝切削 Slot Milling $L/D \leq 3.5$

被削材 Work Material	鋳鉄 Cast Iron FC250		炭素鋼 Carbon Steel		合金鋼 Alloy Steel		調質鋼・プリハードン鋼(快削) Hardened Steel Pre-hardened Steel (Free-Cutting) (~45HRC)		ステンレス鋼 Stainless Steel SUS304	
	外径 DC	回転速度 Speed (min ⁻¹)	送り速度 Feed (mm/min)	回転速度 Speed (min ⁻¹)	送り速度 Feed (mm/min)	回転速度 Speed (min ⁻¹)	送り速度 Feed (mm/min)	回転速度 Speed (min ⁻¹)	送り速度 Feed (mm/min)	回転速度 Speed (min ⁻¹)
10	2,230	360	3,180	450	2,550	270	2,230	170	1,910	130
12	1,860	300	2,650	370	2,120	220	1,860	140	1,590	110
16	1,390	320	1,990	400	1,590	240	1,390	150	1,190	120
20	1,110	360	1,590	450	1,270	270	1,110	170	950	130
25	760	280	1,150	370	890	210	760	130	640	100
切込深さ Depth of Cut	ap=0.5DC									

1. 機械、ホルダは剛性のある精度の高いものをご使用下さい。
 2. 切込深さ、機械剛性等使用状況により、回転速度、送り速度を調整下さい。
 3. 突出し長が長くなる場合は、びびりが発生しやすくなりますので、回転速度、送り速度、切込深さを調整下さい。
 4. 切削条件は、ホルダ端面からのシャンクホルダ(PXMZ)の突出し長さにヘッド全長(LF)を加えた突出し長さを配慮した選定して下さい。
1. Use a rigid and precise machine and holder.
 2. Please adjust the speed and feed when the depth of cut is large or when machines with low rigidity are used.
 3. Please adjust the cutting condition when the overhang length is longer.
 4. Please consider the overhang length as the total length of replaceable head and overhang length of shank holder.

Phoenix PXM

コーナラジラス形状

Corner Radius Type

PXRE

Cutting Conditions

■ 切削条件基準表 Cutting Conditions

PXRE $L/D \leq 3.5$

被削材 Work Material	一般構造用鋼・炭素鋼・鋳鉄 Mild Steel・Carbon Steel・Cast Iron SS400, S55C, FC250 (~750N/mm ²)		合金鋼・工具鋼 Alloy Steel・Tool Steel SCM, SKT, SKS, SKD (~30HRC)		調質鋼(38~45HRC) プリハードン鋼 Hardened Steel・Pre-hardened Steel SKD, NAK80, HPM50		調質鋼 Hardened Steel (45~55HRC)		調質鋼 Hardened Steel (55~60HRC)	
	外径 DC	回転速度 Speed (min ⁻¹)	送り速度 Feed (mm/min)	回転速度 Speed (min ⁻¹)	送り速度 Feed (mm/min)	回転速度 Speed (min ⁻¹)	送り速度 Feed (mm/min)	回転速度 Speed (min ⁻¹)	送り速度 Feed (mm/min)	回転速度 Speed (min ⁻¹)
10	6,370	12,800	4,800	7,800	3,900	6,000	3,300	4,100	2,800	2,700
12	5,310	10,700	4,000	6,500	3,200	4,900	2,700	3,300	2,300	2,300
16	3,980	12,000	3,000	7,700	2,400	5,900	2,000	3,900	1,700	2,500
20	3,190	9,600	2,400	6,500	1,900	4,900	1,600	3,300	1,400	2,200
切込深さ Depth of Cut	$a_p = 0.1 \times \text{コーナ半径(RE)}$ Corner Radius $a_e = 0.3DC$								$a_p = 0.05 \times \text{コーナ半径(RE)}$ Corner Radius $a_e = 0.3DC$	

1. 機械、ホルダは剛性のある精度の高いものをご使用下さい。
 2. 切込深さ、機械剛性等使用状況により、回転速度、送り速度を調整下さい。
 3. 突出し量が長くなる場合は、びびりが発生しやすくなりますので、回転速度、送り速度、切込深さを調整下さい。
 4. 切削条件は、ホルダ端面からのシャンクホルダ(PXMZ)の突出し長さにヘッド全長(LF)を加えた突出し長さを配慮した選定をして下さい。
1. Use a rigid and precise machine and holder.
 2. Please adjust the speed and feed when the depth of cut is large or when machines with low rigidity are used.
 3. Please adjust the cutting condition when the overhang length is longer.
 4. Please consider the overhang length as the total length of replaceable head and overhang length of shank holder.

Phoenix PXM

コーナラジラス形状

Corner Radius Type

PXDR

Cutting Conditions

■切削条件基準表 Cutting Conditions

PXDR-P L/D ≤ 5

被削材 Work Material	一般構造用鋼・炭素鋼・鋳鉄 Mild Steel・Carbon Steel・Cast Iron SS400, S55C, FC250 (~750N/mm ²)		合金鋼・工具鋼 Alloy Steel・Tool Steel SCM, SKT, SKS, SKD (~30HRC)		ステンレス鋼・調質鋼 Stainless Steel・Hardened Steel SUS304, SKD (~45HRC)		調質鋼 Hardened Steel (45 ~ 55HRC)	
	外径 DC	回転速度 Speed (min ⁻¹)	送り速度 Feed (mm/min)	回転速度 Speed (min ⁻¹)	送り速度 Feed (mm/min)	回転速度 Speed (min ⁻¹)	送り速度 Feed (mm/min)	回転速度 Speed (min ⁻¹)
10	4,770	3,580	4,770	2,860	4,770	2,150	4,770	1,430
12	3,980	2,980	3,980	2,390	3,980	1,790	3,980	1,190
16	2,980	2,240	2,980	1,790	2,980	1,340	2,980	900
20	2,390	1,790	2,390	1,430	2,390	1,070	2,390	720
切込深さ Depth of Cut	ap=0.05DC ae=0.25DC						ap=0.03DC ae=0.25DC	

PXDR-N L/D ≤ 5

被削材 Work Material	合金鋼・工具鋼 Alloy Steel・Tool Steel SCM, SKT, SKS, SKD (~30HRC)		ステンレス鋼・調質鋼 Stainless Steel・Hardened Steel SUS304, SKD (~45HRC)		調質鋼 Hardened Steel (45 ~ 55HRC)		調質鋼 Hardened Steel (55 ~ 60HRC)	
	外径 DC	回転速度 Speed (min ⁻¹)	送り速度 Feed (mm/min)	回転速度 Speed (min ⁻¹)	送り速度 Feed (mm/min)	回転速度 Speed (min ⁻¹)	送り速度 Feed (mm/min)	回転速度 Speed (min ⁻¹)
10	4,770	3,580	3,820	2,290	3,180	1,150	3,180	950
12	3,980	2,980	3,180	1,910	2,650	950	2,650	800
16	2,980	2,240	2,390	1,430	1,990	720	1,990	600
20	2,390	1,790	1,910	1,150	1,590	570	1,590	480
切込深さ Depth of Cut	ap=0.03DC ae=0.25DC						ap=0.02DC ae=0.2DC	

- 機械、ホルダは剛性のある精度の高いものをご使用下さい。
 - 切込深さ、機械剛性等使用状況により、回転速度、送り速度を調整下さい。
 - 突出し量が長くなる場合は、びびりが発生しやすくなりますので、回転速度、送り速度、切込深さを調整下さい。
 - 切削条件は、ホルダ端面からのシャンクホルダ(PXMZ)の突出し長さにヘッド全長(LF)を加えた突出し長さを配慮した選定をして下さい。
- Use a rigid and precise machine and holder.
 - Please adjust the speed and feed when the depth of cut is large or when machines with low rigidity are used.
 - Please adjust the cutting condition when the overhang length is longer.
 - Please consider the overhang length as the total length of replaceable head and overhang length of shank holder.

Phoenix PXM

スクエア形状
Square Type

PXSH

Cutting Conditions

■ 切削条件基準表 Cutting Conditions

PXSH 側面切削 Side Milling $L/D \leq 4$

被削材 Work Material	調質鋼 (~45HRC)・ プリハードン鋼 Hardened Steel・Prehardened Steel SCM, SKD61, NAK80		調質鋼 Hardened Steel							
			~55HRC		~62HRC		~66HRC		~70HRC	
切削速度 Cutting Speed (m/min)	110~130		80~100		60~80		50~70		40~60	
外径 DC	回転速度 Speed (min ⁻¹)	送り速度 Feed (mm/min)	回転速度 Speed (min ⁻¹)	送り速度 Feed (mm/min)	回転速度 Speed (min ⁻¹)	送り速度 Feed (mm/min)	回転速度 Speed (min ⁻¹)	送り速度 Feed (mm/min)	回転速度 Speed (min ⁻¹)	送り速度 Feed (mm/min)
12	3,180	2,290	2,390	1,720	1,860	940	1,590	690	1,330	510
16	2,390	2,290	1,790	1,720	1,390	930	1,190	690	1,000	510
20	1,910	2,290	1,430	1,720	1,110	930	960	690	800	510
25	1,530	2,450	1,150	1,840	890	1,000	760	730	640	510
切込深さ Depth of Cut	 $a_p = 1D$ $a_e = 0.05D$ $a_e \text{ Max} = 1\text{mm}$		$a_p = 1D$ $a_e = 0.03D$ $a_e \text{ Max} = 1\text{mm}$		$a_p = 1D$ $a_e = 0.02D$ $a_e \text{ Max} = 0.5\text{mm}$					

PXSH 側面切削 Side Milling $4 < L/D \leq 5$

被削材 Work Material	調質鋼 (~45HRC)・ プリハードン鋼 Hardened Steel・Prehardened Steel SCM, SKD61, NAK80		調質鋼 Hardened Steel							
			~55HRC		~62HRC		~66HRC		~70HRC	
切削速度 Cutting Speed (m/min)	75~95		55~75		40~60		35~55		25~45	
外径 DC	回転速度 Speed (min ⁻¹)	送り速度 Feed (mm/min)	回転速度 Speed (min ⁻¹)	送り速度 Feed (mm/min)	回転速度 Speed (min ⁻¹)	送り速度 Feed (mm/min)	回転速度 Speed (min ⁻¹)	送り速度 Feed (mm/min)	回転速度 Speed (min ⁻¹)	送り速度 Feed (mm/min)
12	2,260	1,630	1,730	1,250	1,330	480	1,190	340	930	200
16	1,690	1,620	1,290	1,240	1,000	480	900	350	700	200
20	1,350	1,620	1,040	1,250	800	480	720	350	560	200
25	1,080	1,730	830	1,330	640	720	570	550	450	360
切込深さ Depth of Cut	 $a_p = 1D$ $a_e = 0.03D$ $a_e \text{ Max} = 1\text{mm}$		$a_p = 1D$ $a_e = 0.02D$ $a_e \text{ Max} = 1\text{mm}$		$a_p = 0.7D$ $a_e = 0.02D$ $a_e \text{ Max} = 0.5\text{mm}$					

- 機械、ホルダは剛性のある精度の高いものをご使用下さい。
- びびりが発生する時は、回転速度、送り速度を同じ割合で下げてご使用下さい。
- 突出し長くなる場合は、びびりが発生しやすくなりますので、回転速度、送り速度、切込深さを調整下さい。
- 切削条件は、ホルダ端面からのシャンクホルダ(PXMZ)の突出し長さにヘッド全長(LF)を加えた突出し長さを配慮した選定をして下さい。
- 切削油剤は被削材に応じてエアブローまたは発煙性の少ない切削油剤をご使用下さい。
 - Use a rigid and precise machine and holder.
 - When chattering occurs, reduce the speed and feed simultaneously.
 - Please adjust the cutting condition when the overhang length is longer.
 - Please consider the overhang length as the total length of replaceable head and overhang length of shank holder.
 - Use an air blow or a suitable cutting fluid with high smoke retardant properties.

Phoenix PXM

スクエア形状

Square Type

PXSH

Cutting Conditions

■切削条件基準表 Cutting Conditions

! 加工時に発生する火花や破損による発熱で引火・火災の危険性があります。
防火対策を必ず行って下さい。

高速高精度のマシニングセンタを利用した場合の基準条件表です。

Caution: Sparks generated during operation or heat caused by tool breakage can cause fire.
Be sure to use all proper fire - prevention measures.

The conditions below are for high speed / high precision machining centers.

PXSH 高速側面切削 High-Speed Side Milling $L/D \leq 4$

被削材 Work Material	調質鋼(～45HRC)・ プリハードン鋼 Hardened Steel・Prehardened Steel SCM, SKD61, NAK80		調質鋼 Hardened Steel							
			～55HRC		～62HRC		～66HRC		～70HRC	
切削速度 Cutting Speed (m/min)	160～180		140～160		95～115		80～100		60～80	
外径 DC	回転速度 Speed (min ⁻¹)	送り速度 Feed (mm/min)	回転速度 Speed (min ⁻¹)	送り速度 Feed (mm/min)	回転速度 Speed (min ⁻¹)	送り速度 Feed (mm/min)	回転速度 Speed (min ⁻¹)	送り速度 Feed (mm/min)	回転速度 Speed (min ⁻¹)	送り速度 Feed (mm/min)
12	4,510	2,600	3,980	2,290	2,790	1,130	2,390	860	1,860	600
16	3,380	2,600	2,990	2,300	2,090	1,130	1,790	860	1,390	600
20	2,710	2,600	2,390	2,290	1,670	1,130	1,430	860	1,110	600
25	2,170	2,780	1,910	2,440	1,340	1,210	1,150	920	890	640
切込深さ Depth of Cut	 $a_p = 1D$ $a_e = 0.05D$ $a_e \text{ Max} = 1\text{mm}$		$a_p = 1D$ $a_e = 0.03D$ $a_e \text{ Max} = 1\text{mm}$		$a_p = 1D$ $a_e = 0.015D$ $a_e \text{ Max} = 0.5\text{mm}$		$a_p = 1D$ $a_e = 0.01D$ $a_e \text{ Max} = 0.2\text{mm}$			

1. 摩擦が進行すると火花が発生しますので、発火性のある切削油剤は絶対に使用しないで下さい。

2. 機械、ホルダは剛性のある精度の高いものをご使用下さい。

3. びびりが発生する時は、回転速度、送り速度を同じ割合で下げてご使用下さい。

4. 切削条件は、ホルダ端面からのシャンクホルダ(PXMZ)の突出し長さにヘッド全長(LF)を加えた突出し長さを配慮した選定をして下さい。

5. 切削油剤は被削材に応じてエアブローまたは発煙性の少ない切削油剤をご使用下さい。

1. Tools can cause sparks. Do not use flammable fluids.

2. Use a rigid and precise machine and holder.

3. When chattering occurs, reduce the speed and feed simultaneously.

4. Please consider the overhang length as the total length of replaceable head and overhang length of shank holder.

5. Use an air blow or a suitable cutting uid with high smoke retardant properties.

Phoenix PXM

ラジラス形状
Radius Type

PXHF-AM

Cutting Conditions

■ 切削条件基準表 Cutting Conditions

PXHF-AM

・ランピング加工時の最大傾斜角(E°) Maximum Ramping Angle(E°)

呼び Designation	ランピング角度 Ramping Angle E°	ヘリカル穴あけ Helical Milling (mm)		ヘリカル角度 Helical Angle P°
		最小径 Do Min.	最大径 Do Max.	
PXHF-AM120C12-06R150-O	3°	18	23	1.5°
PXHF-AM160C16-06R200-O		24	31	
PXHF-AM200C20-06R250-O		30	39	

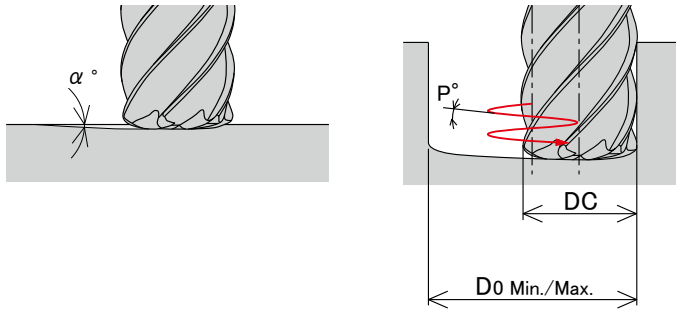

・プログラム作成上の刃先形状定義 Edge shape definitions for the purpose of creating a program

呼び Designation	擬似R rt	削り残し量 Remainder Z
PXHF-AM120C12-06R150-O	R1.5	0.36
PXHF-AM160C16-06R200-O	R2	0.47
PXHF-AM200C20-06R250-O	R2.5	0.59

加工に際しては、それぞれ擬似Rのラジラスエンドミルとして加工プログラムを作成下さい。
During machining, please program the milling paths according to the recommended simulated R (rt) respective to the individual end mill diameter.

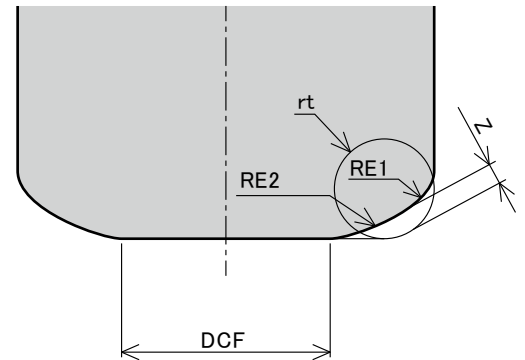

Phoenix PXM

ラジラス形状
Radius Type

PXHF-AM

Cutting Conditions

■切削条件基準表 Cutting Conditions

加工に際しては、それぞれ擬似Rのラジラスエンドミルとして加工プログラムを作成下さい。

During machining, please program the milling paths according to the recommended simulated R (rt) respective to the individual end mill diameter.

PXHF-AM 正面切削 Frontal Milling L/D ≤ 4

被削材 Work Material	調質鋼・プリハードン鋼 Hardened Steel・ Prehardened Steel		調質鋼 Hardened Steel				ステンレス鋼 Stainless Steel		コバルトクロム基 Cobalt-Chromium Based Alloy (Stellite)		チタン合金 Titanium Alloy		Ni 基合金 Ni-Based Alloy (Inconel 718)	
	~45HRC		~62HRC		~70HRC		≤200HB							
切削速度 Cutting Speed (m/min)	110~130		90~110		65~85		125~145		110~130		90~110		30~50	
外径 DC	回転速度 Speed (min ⁻¹)	送り速度 Feed (mm/min)	回転速度 Speed (min ⁻¹)	送り速度 Feed (mm/min)	回転速度 Speed (min ⁻¹)	送り速度 Feed (mm/min)	回転速度 Speed (min ⁻¹)	送り速度 Feed (mm/min)	回転速度 Speed (min ⁻¹)	送り速度 Feed (mm/min)	回転速度 Speed (min ⁻¹)	送り速度 Feed (mm/min)	回転速度 Speed (min ⁻¹)	送り速度 Feed (mm/min)
12	3,180	5,270	2,650	4,390	1,990	1,580	3,580	5,930	3,180	5,270	2,650	4,390	1,060	760
16	2,390	5,280	1,990	4,390	1,490	1,570	2,690	5,940	2,390	5,280	1,990	4,390	800	770
20	1,910	5,270	1,590	4,390	1,190	1,570	2,150	5,930	1,910	5,270	1,590	4,390	640	770
切込深さ Depth of Cut	<p>$a_p = \text{Max} : 0.04D$ $a_e = \text{Max} : 0.5D$</p>													

PXHF-AM 正面切削 Frontal Milling 4 < L/D ≤ 5

被削材 Work Material	調質鋼・プリハードン鋼 Hardened Steel・ Prehardened Steel		調質鋼 Hardened Steel				ステンレス鋼 Stainless Steel		コバルトクロム基 Cobalt-Chromium Based Alloy (Stellite)		チタン合金 Titanium Alloy		Ni 基合金 Ni-Based Alloy (Inconel 718)	
	~45HRC		~62HRC		~70HRC		≤200HB							
切削速度 Cutting Speed (m/min)	100~120		80~100		60~80		115~135		100~120		80~100		25~45	
外径 DC	回転速度 Speed (min ⁻¹)	送り速度 Feed (mm/min)	回転速度 Speed (min ⁻¹)	送り速度 Feed (mm/min)	回転速度 Speed (min ⁻¹)	送り速度 Feed (mm/min)	回転速度 Speed (min ⁻¹)	送り速度 Feed (mm/min)	回転速度 Speed (min ⁻¹)	送り速度 Feed (mm/min)	回転速度 Speed (min ⁻¹)	送り速度 Feed (mm/min)	回転速度 Speed (min ⁻¹)	送り速度 Feed (mm/min)
12	2,920	3,780	2,390	3,100	1,860	1,210	3,320	4,300	2,920	3,780	2,390	3,100	930	540
16	2,190	3,780	1,790	3,090	1,390	1,200	2,490	4,300	2,190	3,780	1,790	3,090	700	540
20	1,750	3,780	1,430	3,090	1,110	1,200	1,990	4,300	1,750	3,780	1,430	3,090	560	540
切込深さ Depth of Cut	<p>$a_p = \text{Max} : 0.03D$ $a_e = \text{Max} : 0.5D$</p>													

1. 本工具はアディティブ・マニファクチャリング(金属積層)、金型肉盛り部表面の荒取り加工に使用することを推奨します。
2. 機械、ホルダは剛性のある精度の高いものをご使用下さい。
3. 上表の値はあくまでも目安です。実際の加工における切削条件は上表を参考に状況に応じて設定下さい。
4. 推奨条件よりも切込み量を大きくする場合は、送り速度を抑えてご使用下さい。
5. 突出し長さが長くなる場合は、ひびりが発生しやすくなりますので、回転速度、送り速度、切込み深さを調整下さい。
6. 切削油剤は被削材に適したもので、発煙性の少ないものをご使用下さい。
7. 乾式の場合には、切りくず詰まりが無いようエアブローにて切りくずを除去下さい。
8. ステンレス鋼、コバルトクロム合金、チタン合金、Ni 基合金の加工には、水溶性切削油剤の使用を推奨します。
9. 工具の振れ精度を最小限に抑えてご使用下さい。
10. コーナ部等切削負荷が変動する場合は、回転速度を抑えてご使用下さい。
11. ピック量が0.5D以上の場合、加工面にカスプが発生することがあります。

1. This tool is recommended for the roughing of additive manufacturing and mold overlay surfaces.
2. Please use machines and holders that are rigid and highly accurate.
3. The values listed above are for reference. Please set the cutting condition in accordance with the actual machining environment.
4. Please reduce the feed rate when the depth of cut is greater than specified.
5. Please adjust the cutting condition when the overhang length is longer.
6. Please use a suitable fluid with high smoke retardant properties.
7. During dry (no fluid) milling, please use air blow to remove disposable chips from the milling area and to eliminate chip packing.
8. Please use water-soluble coolant when machining stainless steel, cobalt-chromium alloy, titanium alloy, and Ni-based alloy.
9. Tool runout should be kept to a minimum for maximum accuracy.
10. When the cutting load fluctuates in areas such as the corners, please reduce the rotational speed.
11. If the pick amount is 0.5 x D or more, cusp may occur on the machined surface.

PXHF-AM 正面切削 Frontal Milling $5 < L/D \leq 6$

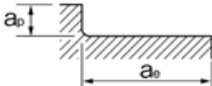
被削材 Work Material	調質鋼・プリハードン鋼 Hardened Steel・ Prehardened Steel		調質鋼 Hardened Steel				ステンレス鋼 Stainless Steel		コバルトクロム基 Cobalt-Chromium Based Alloy (Stellite)		チタン合金 Titanium Alloy		Ni 基合金 Ni-Based Alloy (Inconel 718)	
	~45HRC		~62HRC		~70HRC		≤200HB							
切削速度 Cutting Speed (m/min)	90~110		70~90		50~70		100~120		90~110		70~90		20~40	
外径 DC	回転速度 Speed (min ⁻¹)	送り速度 Feed (mm/min)	回転速度 Speed (min ⁻¹)	送り速度 Feed (mm/min)	回転速度 Speed (min ⁻¹)	送り速度 Feed (mm/min)	回転速度 Speed (min ⁻¹)	送り速度 Feed (mm/min)	回転速度 Speed (min ⁻¹)	送り速度 Feed (mm/min)	回転速度 Speed (min ⁻¹)	送り速度 Feed (mm/min)	回転速度 Speed (min ⁻¹)	送り速度 Feed (mm/min)
12	2,650	2,670	2,120	2,140	1,590	800	2,920	2,940	2,650	2,670	2,120	2,140	800	350
16	1,990	2,670	1,590	2,140	1,190	800	2,190	2,940	1,990	2,670	1,590	2,140	600	350
20	1,590	2,670	1,270	2,130	960	810	1,750	2,940	1,590	2,670	1,270	2,130	480	350
切込深さ Depth of Cut	 <p>$a_p = \text{Max} : 0.02D$ $a_e = \text{Max} : 0.5D$</p>													

1. 本工具はアディティブ・マニュファクチャリング(金属積層)、金型肉盛り部表層の荒取り加工に使用することを推奨します。
2. 機械、ホルダは剛性のある精度の高いものをご使用下さい。
3. 上表の値はあくまでも目安です。実際の加工における切削条件は上表を参考に状況に応じて設定下さい。
4. 推奨条件よりも切込み量を大きくとる場合は、送り速度を抑えてご使用下さい。
5. 突出し長さが長くなる場合は、びびりが発生しやすくなりますので、回転速度、送り速度、切込み深さを調整下さい。
6. 推奨油剤は被削材に適したもので、発煙性の少ないものをご使用下さい。
7. 乾式の場合には、切りくず詰まりが無いようエアブローにて切りくずを除去下さい。
8. ステンレス鋼、コバルトクロム合金、チタン合金、Ni 基合金の加工には、水溶性切削油剤の使用を推奨します。
9. 工具の振れ精度を最小限に抑えてご使用下さい。
10. コーナ部等切削負荷が変動する場合は、回転速度を抑えてご使用下さい。
11. ピック量が0.5D以上の場合、加工面にカスプが発生することがあります。

1. This tool is recommended for the roughing of additive manufacturing and mold overlay surfaces.
2. Please use machines and holders that are rigid and highly accurate.
3. The values listed above are for reference. Please set the cutting condition in accordance with the actual machining environment.
4. Please reduce the feed rate when the depth of cut is greater than specified.
5. Please adjust the cutting condition when the overhang length is longer.
6. Please use a suitable fluid with high smoke retardant properties.
7. During dry (no fluid) milling, please use air blow to remove disposable chips from the milling area and to eliminate chip packing.
8. Please use water-soluble coolant when machining stainless steel, cobalt-chromium alloy, titanium alloy, and Ni-based alloy.
9. Tool runout should be kept to a minimum for maximum accuracy.
10. When the cutting load fluctuates in areas such as the corners, please reduce the rotational speed.
11. If the pick amount is $0.5 \times D$ or more, cusp may occur on the machined surface.

Phoenix PXM

ラジラス形状

Radius Type

PXHF-AM

Cutting Conditions

■切削条件基準表 Cutting Conditions

加工に際しては、それぞれ擬似Rのラジラスエンドミルとして加工プログラムを作成下さい。

During machining, please program the milling paths according to the recommended simulated R (rt) respective to the individual end mill diameter.

PXHF-AM 側面切削 Side Milling

被削材 Work Material	調質鋼・プリハードン鋼 Hardened Steel・ Prehardened Steel		調質鋼 Hardened Steel				ステンレス鋼 Stainless Steel		コバルトクロム基 Cobalt-Chromium Based Alloy (Stellite)	チタン合金 Titanium Alloy		Ni基合金 Ni-Based Alloy (Inconel 718)		
	~45HRC		~62HRC		~70HRC		≤200HB							
切削速度 Cutting Speed (m/min)	80~100		50~70		50~70		100~120		90~110		70~90		30~50	
外径 DC	回転速度 Speed (min ⁻¹)	送り速度 Feed (mm/min)	回転速度 Speed (min ⁻¹)	送り速度 Feed (mm/min)	回転速度 Speed (min ⁻¹)	送り速度 Feed (mm/min)	回転速度 Speed (min ⁻¹)	送り速度 Feed (mm/min)	回転速度 Speed (min ⁻¹)	送り速度 Feed (mm/min)	回転速度 Speed (min ⁻¹)	送り速度 Feed (mm/min)	回転速度 Speed (min ⁻¹)	送り速度 Feed (mm/min)
12	2,390	1,200	1,590	570	1,060	230	2,650	1,340	2,390	1,200	1,590	570	800	230
16	1,790	1,200	1,190	570	800	230	1,990	1,340	1,790	1,200	1,190	570	600	230
20	1,430	1,200	960	580	640	230	1,590	1,340	1,430	1,200	960	580	480	230
切込深さ Depth of Cut	ap=Max : 0.5D ae=Max : 0.05D		ap=Max : 0.5D ae=Max : 0.02D				ap=Max : 0.5D ae=Max : 0.05D				ap=Max : 0.5D ae=Max : 0.02D			

1. 本工具はアディティブ・マニュファクチャリング(金属積層)、金型肉盛り部表面の荒取り加工に使用することを推奨します。
2. 機械、ホルダは剛性のある精度の高いものをご使用下さい。
3. 上表の値はあくまでも目安です。実際の加工における切削条件は上表を参考に状況に応じて設定下さい。
4. 推奨条件よりも切込み量を大きくとる場合は、送り速度を抑えてご使用下さい。
5. 上表は、工具の突出量が4D以下の場合の目安です。突出量が多い場合は、びびりが発生しやすくなりますので、回転速度、送り速度、切込み深さを調整下さい。
6. 切削油剤は被削材に適したもので、発煙性の少ないものをご使用下さい。
7. 乾式の場合には、切りくず詰まりが無いようエアブローにて切りくずを除去下さい。
8. ステンレス鋼、コバルトクロム合金、チタン合金、Ni基合金の加工には、水溶性切削油剤の使用を推奨します。
9. 工具の振れ精度を最小限に抑えてご使用下さい。
10. コーナ部等切削負荷が変動する場合は、回転速度を抑えてご使用下さい。

1. This tool is recommended for the roughing of additive manufacturing and mold overlay surfaces.
2. Please use machines and holders that are rigid and highly accurate.
3. The values listed above are for reference. Please set the cutting condition in accordance with the actual machining environment.
4. Please reduce the feed rate when the depth of cut is greater than specified.
5. The above table is a guide when the amount of protrusion of the tool is 4 x D or less. If the amount of protrusion is large, chatter is likely to occur, so adjust the rotation speed, feed rate and depth of cut.
6. Please use a suitable fluid with high smoke retardant properties.
7. During dry (no fluid) milling, please use air blow to remove disposable chips from the milling area and to eliminate chip packing.
8. Please use water-soluble coolant when machining stainless steel, cobalt-chromium alloy, titanium alloy, and Ni-based alloy.
9. Tool runout should be kept to a minimum for maximum accuracy.
10. When the cutting load fluctuates in areas such as the corners, please reduce the rotational speed.

Phoenix PXM

ボール形状

Ball Type

PXBE

Cutting Conditions

■ 切削条件基準表 Cutting Conditions

PXBE-P L/D ≤ 5

被削材 Work Material	一般構造用鋼・炭素鋼・鋳鉄 Mild Steel・Carbon Steel Cast Iron SS400, S55C, FC250 (~750N/mm ²)		合金鋼・工具鋼 Alloy Steel・Tool Steel SCM, SKT, SKS, SKD (~30HRC)		ステンレス鋼・調質鋼 Stainless Steel Hardened Steel SUS304, SKD (~45HRC)		調質鋼・チタン合金 Hardened Steel Titanium Alloy (Wet) Ti-6Al-4V (45 ~ 55HRC)	
	外径 DC	回転速度 Speed (min ⁻¹)	送り速度 Feed (mm/min)	回転速度 Speed (min ⁻¹)	送り速度 Feed (mm/min)	回転速度 Speed (min ⁻¹)	送り速度 Feed (mm/min)	回転速度 Speed (min ⁻¹)
10	4,770	2,150	3,820	1,720	3,180	1,430	3,180	950
12	3,980	1,790	3,180	1,430	2,650	1,190	2,650	800
16	2,980	1,340	2,390	1,070	1,990	900	1,990	600
20	2,390	1,070	1,910	860	1,590	720	1,590	480
切込深さ Depth of Cut	a _p =0.07DC P f=0.15DC						a _p =0.04DC P f=0.1DC	

PXBE-N L/D ≤ 3.5

被削材 Work Material	一般構造用鋼・炭素鋼・鋳鉄 Mild Steel・Carbon Steel Cast Iron SS400, S55C, FC250 (~750N/mm ²)		合金鋼・工具鋼 Alloy Steel・Tool Steel SCM, SKT, SKS, SKD (~30HRC)		ステンレス鋼・調質鋼 Stainless Steel Hardened Steel SUS304, SKD (~45HRC)		調質鋼・チタン合金 Hardened Steel Titanium Alloy (Wet) Ti-6Al-4V (45 ~ 55HRC)		調質鋼 Hardened Steel (55 ~ 60HRC)	
	外径 DC	回転速度 Speed (min ⁻¹)	送り速度 Feed (mm/min)	回転速度 Speed (min ⁻¹)	送り速度 Feed (mm/min)	回転速度 Speed (min ⁻¹)	送り速度 Feed (mm/min)	回転速度 Speed (min ⁻¹)	送り速度 Feed (mm/min)	回転速度 Speed (min ⁻¹)
10	7,960	3,580	7,960	3,580	6,370	2,290	4,770	1,430	3,180	480
12	6,630	2,980	6,630	2,980	5,310	1,910	3,980	1,190	2,650	400
16	4,970	2,240	4,970	2,240	3,980	1,430	2,980	900	1,990	300
20	3,980	1,790	3,980	1,790	3,180	1,150	2,390	720	1,590	240
切込深さ Depth of Cut	a _p =0.05DC P f=0.15DC						a _p =0.04DC P f=0.1DC		a _p =0.03DC P f=0.05DC	

1. 機械、ホルダは剛性のある精度の高いものをご使用下さい。
 2. 切込深さ、機械剛性等使用状況により、回転速度、送り速度を調整下さい。
 3. 突出し長くなる場合は、びびりが発生しやすくなりますので、回転速度、送り速度、切込深さを調整下さい。
 4. 切削条件は、ホルダ端面からのシャンクホルダ(PXMZ)の突出し長さにヘッド全長(LF)を加えた突出し長さを配慮した選定して下さい。
1. Use a rigid and precise machine and holder.
 2. Please adjust the speed and feed when the depth of cut is large or when machines with low rigidity are used.
 3. Please adjust the cutting condition when the overhang length is longer.
 4. Please consider the overhang length as the total length of replaceable head and overhang length of shank holder.

Phoenix PXM

ボール形状

Ball Type

PXBM

Cutting Conditions

■切削条件基準表 Cutting Conditions

PXBM L/D ≤ 3.5

被削材 Work Material	一般構造用鋼・炭素鋼・鋳鉄 Mild Steel・Carbon Steel Cast Iron		合金鋼・工具鋼 Alloy Steel Tool Steel		ステンレス鋼・調質鋼 Stainless Steel Hardened Steel		調質鋼・チタン合金(湿式) Hardened Steel Titanium Alloy (Wet)		調質鋼 Hardened Steel	
	SS400, S55C, FC250 (~750N/mm ²)		SCM, SKT, SKS, SKD (~30HRC)		SUS304, SKD (~45HRC)		Ti-6Al-4V (45~55HRC)		(55~60HRC)	
外径 DC	回転速度 Speed (min ⁻¹)	送り速度 Feed (mm/min)	回転速度 Speed (min ⁻¹)	送り速度 Feed (mm/min)	回転速度 Speed (min ⁻¹)	送り速度 Feed (mm/min)	回転速度 Speed (min ⁻¹)	送り速度 Feed (mm/min)	回転速度 Speed (min ⁻¹)	送り速度 Feed (mm/min)
10	7,960	4,770	7,960	4,770	6,360	3,050	4,770	1,910	3,180	640
12	6,630	3,980	6,630	3,980	5,300	2,540	3,980	1,590	2,650	530
16	4,970	4,480	4,970	4,480	3,970	2,860	2,980	1,790	1,990	600
20	3,980	3,580	3,980	3,580	3,180	2,290	2,390	1,430	1,590	480
切込深さ Depth of Cut	$a_p = 0.02DC$ $P_f = 0.05DC$									

1. 機械、ホルダは剛性のある精度の高いものをご使用下さい。
 2. 切込深さ、機械剛性等使用状況により、回転速度、送り速度を調整下さい。
 3. 突出し量が長くなる場合は、びびりが発生しやすくなりますので、回転速度、送り速度、切込深さを調整下さい。
 4. 切削条件は、ホルダ端面からのシャンクホルダ(PXMZ)の突出し長さ(ヘッド全長(LF))を加えた突出し長さを配慮した選定をして下さい。
1. Use a rigid and precise machine and holder.
 2. Please adjust the speed and feed when the depth of cut is large or when machines with low rigidity are used.
 3. Please adjust the cutting condition when the overhang length is longer.
 4. Please consider the overhang length as the total length of replaceable head and overhang length of shank holder.

Cutting Data

加工データ Cutting Data

[PXSE] 耐久1.6倍で工具費1/5 ~部品加工~ 1.6 times durability and 1/5 of tooling cost achieved in parts machining

使用工具 Tool	ヘッド: PXSE200C20-04R010 Head ホルダ: PXMZ-C20SS20-S120 Holder	他社超硬ソリッドエンドミル Competitor's Solid Carbide End Mill
サイズ Size	φ20×R1 4刃 Flutes	
加工ワーク Work	機械部品 Machine Parts	
被削材 Work Material	S25C	
切削速度 Cutting Speed	60m/min (1,000min ⁻¹)	
送り速度 Feed	400mm/min (0.1mm/t)	
切削方法 Cutting Method	溝切削 Slotting	
切込深さ Depth of Cut	ap=3mm ae=20mm	
切削油剤 Coolant	水溶性切削油剤 Water-Soluble	
使用機械 Machine	横形マシニングセンタ(BT50) Horizontal Machining Center	
加工ワーク数 Number of Processed Workplace	5個 PCS	3個 PCS

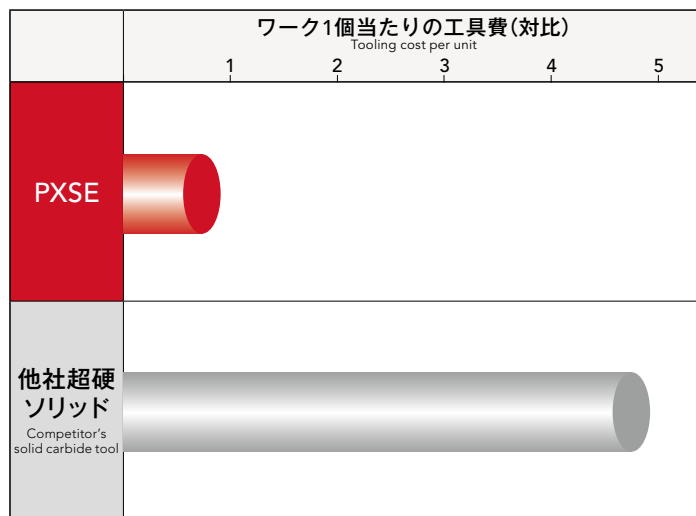

ソリッド工具に対し1.6倍の耐久。ワーク1個当たりの工具費が1/5となった。
The tool achieved 1.6 times durability. Tooling cost per unit was reduced to 1/5.

[PXVC] 加工面粗さ、加工精度共にソリッド工具よりも良好 Achieved better surface roughness and accuracy versus competitor

使用工具 Tool	ヘッド: PXVC220C20-04R005 Head ホルダ: PXMZ-C20SS20-L150L Holder	従来ソリッドエンドミル Conventional Solid End Mill
サイズ Size	φ22×R0.5	φ20
被削材 Work Material	SKD61 (40HRC)	
切削速度 Cutting Speed	50m/min (723min ⁻¹)	50m/min (796min ⁻¹)
送り速度 Feed	300mm/min (0.104mm/t)	60mm/min (0.019mm/t)
切削方法 Cutting Method	側面加工 Side Milling	
切込深さ Depth of Cut	ap=17.6mm (0.8D) ae=0.05mm	ap=88mm (4.4D) ae=0.05mm
切削油剤 Coolant	なし(エアブロー) Air Blow	
使用機械 Machine	立形マシニングセンタ(BT50) Vertical Machining Center	

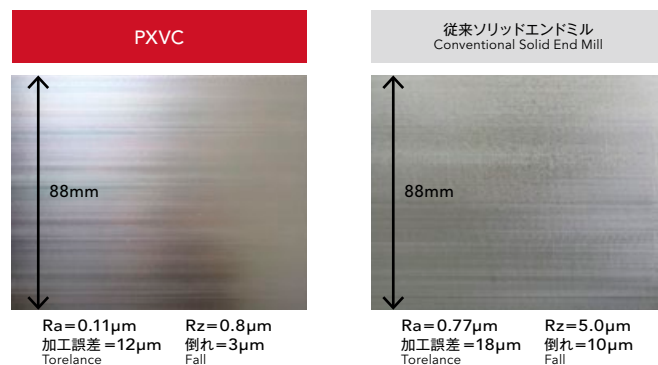

PXVCは従来のソリッド工具と同一加工効率でソリッド工具よりも良好な加工精度と加工面粗さを得ることができた。
PXVC achieved better accuracy and finished surface in same machining efficiency versus the competition.

[PXSM] 多刃化により加工効率2倍 ~ブレード加工~ The multiple edge design helps double efficiency in the milling of blades

使用工具 Tool	ヘッド: PXSM160C16-06R005 Head ホルダ: PXMZ-C16SS16-L130CS Holder	他社丸駒カッタ Competitor's Radius Cutter
サイズ Size	φ16×R0.5 6刃 Flutes	φ16×R2.5 2刃 Flutes
材種 Grades	XP3225	超硬コーティングインサート Coated Carbide Insert
被削材 Work Material	13Cr相当品 Equivalent	
切削速度 Cutting Speed	125m/min (2,500min ⁻¹)	
送り速度 Feed	690mm/min (0.046mm/t)	350mm/min (0.07mm/t)
切込深さ Depth of Cut	ap=1mm ae=0.25mm	
切削油剤 Coolant	なし(エアブロー) Air Blow	
使用機械 Machine	立形5軸マシニングセンタ 5-Axis Vertical Machining Center	

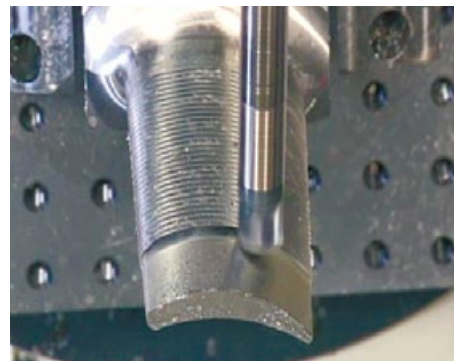

条件アップの難しい仕上げ工程において、丸駒カッタをPXSMに変更することで加工効率が2倍となった。
In finishing operations with settings that are difficult to modify, switching to the Phoenix Radius Cutter can double milling efficiency.

Cutting Data

加工データ Cutting Data

【PXAL】ざらい刃効果で加工面粗さ向上 Improved surface roughness by the effect of the flat cutting edge specification

使用工具 Tool	ヘッド: PXAL160C16-03R000 Head ホルダ: PXMZ-C16SS16-S100 Holder	他社ノンコート品 A, B, C Non-coated Competitor
サイズ Size	φ16	φ16 3刃 Flutes
被削材 Work Material	A7075	
切削方法 Milling Method	側面加工 Side Milling	
切削速度 Cutting Speed	600m/min (12,000min ⁻¹)	
送り速度 Feed	5,400mm/min (0.15mm/t)	
切込深さ Depth of Cut	ap=8mm(0.5D) ae=4.8mm(0.3D)	
突出し長さ Overhang Length	50mm(L/D = 3.1)	
切削油剤 Coolant	水溶性切削油剤 Water-Soluble	
使用機械 Machine	立形マシニングセンタ(BT40) Vertical Machining Center	

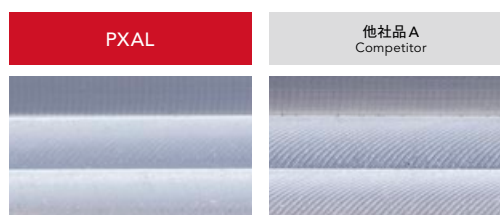
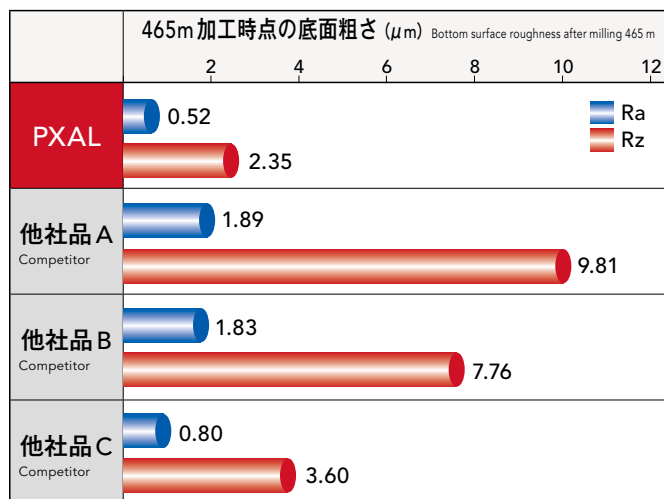

【PXAL】クーラント種類を問わず良好な加工面粗さを実現 Achieves good surface finish regardless of coolant type

使用工具 Tool	ヘッド: PXAL160C16-03R000 Head ホルダ: PXMZ-C16SS16-S100 Holder	他社ノンコート品 Non-coated Competitor
サイズ Size	φ16	φ16 3刃 Flutes
被削材 Work Material	A7075	
切削方法 Milling Method	側面加工 Side Milling	
切削速度 Cutting Speed	600m/min (12,000min ⁻¹)	
送り速度 Feed	2,700mm/min (0.075mm/t)	
切込深さ Depth of Cut	ap=8mm(0.5D) ae=4.8mm(0.3D)	
突出し長さ Overhang Length	50mm(L/D = 3.1)	
使用機械 Machine	立形マシニングセンタ(BT40) Vertical Machining Center	

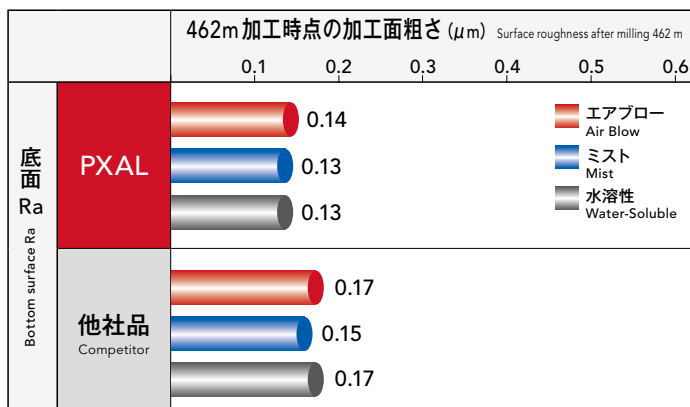
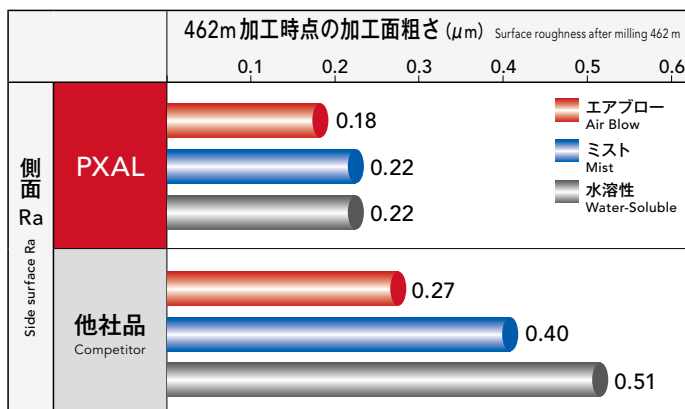

[PXAL] DLCコーティングにより溶着抑制 Welding suppression by DLC coating

使用工具 Tool	ヘッド : PXAL160C16-03R010 Head ホルダ : PXMZ-C16SS16-S100 Holder	他社ノンコート品 Non-coated Competitor
サイズ Size	φ16 × R1	φ16 × R1 3刃 Flutes
被削材 Work Material	A7075	
切削速度 Cutting Speed	600m/min (12,000min ⁻¹)	
送り速度 Feed	2,700mm/min (0.075mm/t)	
切削方法 Milling Method	側面加工 Side Milling	
切込深さ Depth of Cut	ap=8mm(0.5D) ae=4.8mm(0.3D)	
突出し長さ Overhang Length	50mm(L/D = 3.1)	
切削油剤 Coolant	なし(エアブロー) Air Blow	
使用機械 Machine	立形マシニングセンタ(BT40) Vertical Machining Center	

300m 加工時の刃先状態

Cutting edge condition after milling 300 m

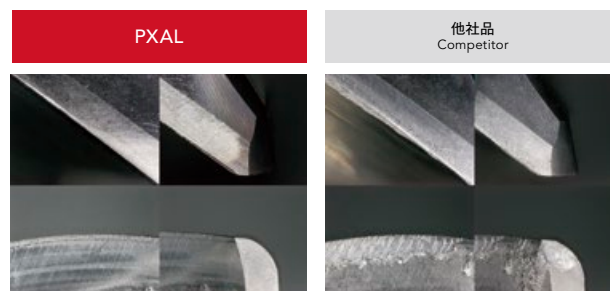

[PXNH] 不等リードの効果により、低抵抗の加工を実現 The variable lead enables low-resistance machining

使用工具 Tool	ヘッド : PXNH200C20-04C006 Head ホルダ : PXMZC20SS20-S120 Holder	他社インデキサブル ラフィング刃 A, B Competitors' indexable roughing cutter
サイズ Size	φ20 4刃 Flutes	φ20 6刃 Flutes
被削材 Work Material	S50C	
切削速度 Cutting Speed	100m/min (1,590min ⁻¹)	
送り速度 Feed	450mm/min (0.07mm/t)	450mm/min (0.047mm/t)
切削方法 Cutting Method	溝切削 Slotting	
切込深さ Depth of Cut	ap=6mm, 8mm, 10mm	
切削油剤 Coolant	なし(エアブロー) Air Blow	
使用機械 Machine	立形マシニングセンタ(BT40) Vertical Machining Center	

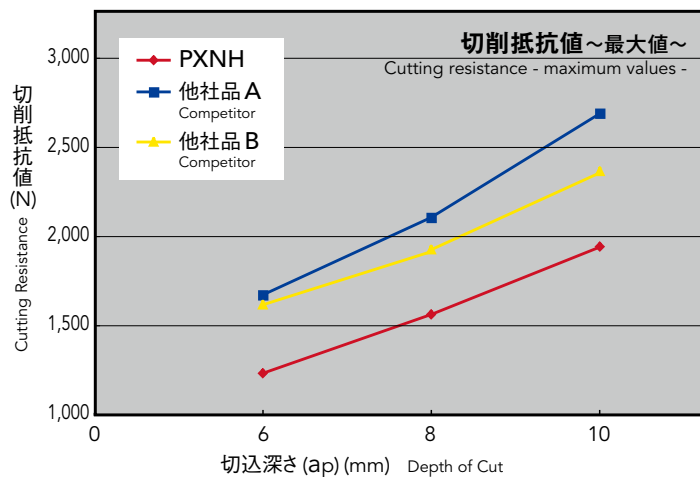

他社品より20%以上の抵抗値を低減することが可能となった。
The resistance value can be reduced by more than 20% from the competitors' products.

Cutting Data

■加工データ Cutting Data

■[PXNL] 不等リード形状により安定加工、長寿命加工を実現 The variable lead enables stable machining and a long tool life

使用工具 Tool	ヘッド: PXNL200C20-04C006 Head ホルダ: PXMZC20SS20-S120 Holder	他社インデキサブル ラフィング刃 A, B Competitors' indexable roughing cutter
サイズ Size	φ20 4刃 Flutes	φ20 6刃 Flutes
被削材 Work Material	S50C	
切削速度 Cutting Speed	120m/min (1,910min ⁻¹)	
送り速度 Feed	764mm/min (0.1mm/t)	764mm/min (0.066mm/t)
切削方法 Cutting Method	側面切削 Side Milling	
切込深さ Depth of Cut	ap=10mm (0.5D) ae=6mm (0.3D)	
切削油剤 Coolant	なし(エアブロー) Air Blow	
使用機械 Machine	立形マシニングセンタ(BT40) Vertical Machining Center	

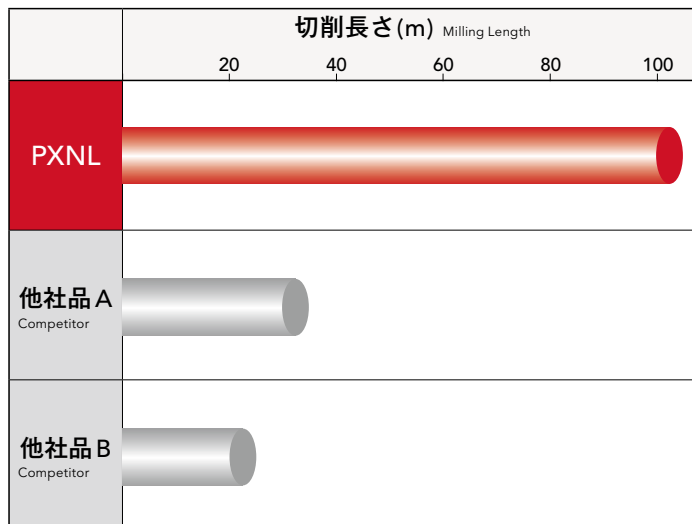

他社品より2倍以上の耐久を実現。

More than twice the durability of the competitors' products.

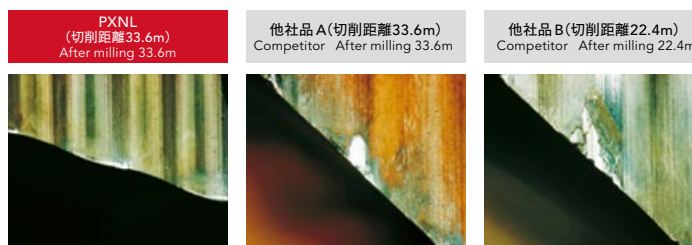

■[PXRE] 多刃化により加工効率1.8倍 ~金型中荒工程~ The multiple edge design helps increase efficiency by 1.8 times in die mold roughing processes

使用工具 Tool	ヘッド: PXRE200C20-06R030 Head ホルダ: PXMZ-C20SS20-S120 Holder	他社高送りラジラスカッタ 超硬コーティングインサート Competitor's High Feed Radius Cutter/Coated Carbide Insert
サイズ Size	φ20×R3 6刃 Flutes	φ20×R3 2刃 Flutes
被削材 Work Material	SKD61 (43HRC)	
切削速度 Cutting Speed	230m/min (3,700min ⁻¹)	120m/min (1,900min ⁻¹)
送り速度 Feed	6,700mm/min (0.3mm/t)	3,100mm/min (0.8mm/t)
切込深さ Depth of Cut	0.4mm	0.5mm
切削幅 Width of Cut	10mm	
切削油剤 Coolant	なし(エアブロー) Air Blow	
使用機械 Machine	横形マシニングセンタ(BT50) Horizontal Machining Center	

中荒工程の高送りラジラスカッタをPXREに置き換えることで加工効率1.8倍

By replacing the high feed radius cutter with the PXRE, milling efficiency can be increased by 1.8 times

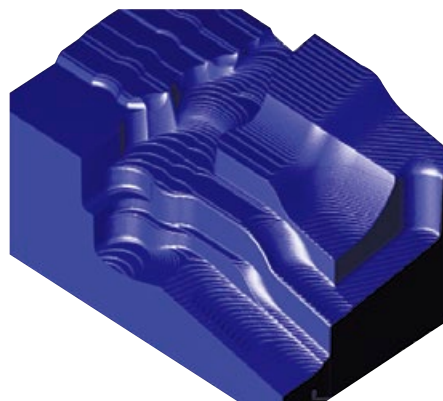

他社高送りラジラスカッタでは、擬似Rを入力したプログラムを使用していたため、中荒工程でも大きな削り残しが発生していた。高精度なコーナR形状のPXREでは、削り残しが少なく、次工程での加工負荷が安定した。その上、工具寿命、加工精度も向上した。

With high feed radius cutters, a simulated R value is inputted in the program during rough milling, resulting in large amounts of uncut areas. In contrast, with the high precision Corner R form PXRE, there are fewer uncut areas, which reduce the load of the next process, thereby increasing tool life and the precision of cut.

[PXDR-P] びびりやすいL/D=7でも安定加工を実現 Stable machining was achieved in easily chatter L/D=7

使用工具 Tool	ヘッド : PXDR160C16-03R030-P Head ホルダ : PXMZ-C16SS16-L135CS Holder	他社品 A, B Competitor
サイズ Size	φ16×R3 3刃 Flutes	φ16×R3 4刃 Flutes
被削材 Work Material	NAK80 40HRC	
切削速度 Cutting Speed	30m/min (597min ⁻¹)	
送り速度 Feed	537mm/min (0.30mm/t)	537mm/min (0.22mm/t)
切削方法 Cutting Method	L字加工 L-shaped machining	
切込深さ Depth of Cut	ap=0.4mm (0.025Dc) ae=8mm (0.5Dc)	
工具突出し長 Overhang Length	112mm (L/D=7)	
切削油剤 Coolant	なし(エアブロー) Air Blow	
使用機械 Machine	立形マシニングセンタ(BT40) Vertical Machining Center	

PXDR-Pは他社品と比較してびびりが小さく、コーナ部においても良好な加工面が得られた。

PXDR-P achieved fair finished surface with less chattering at the corner of work versus the competition.

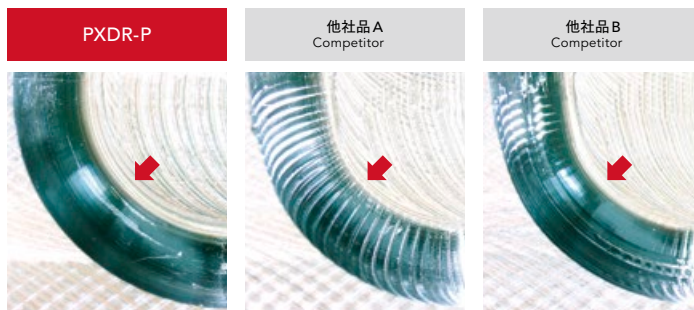

[PXDR-N] びびりやすいL/D=7での環境において長寿命化を実現 Long tool life was achieved machining in L/D=7, which chatters easily

使用工具 Tool	ヘッド : PXDR160C16-03R030-N Head ホルダ : PXMZ-C16SS16-L135CS Holder	他社品 A, B Competitor
サイズ Size	φ16×R3 3刃 Flutes	φ16×R3 4刃 Flutes
被削材 Work Material	SKD61 (40HRC)	
切削速度 Cutting Speed	120m/min (2,387min ⁻¹)	
送り速度 Feed	2,149mm/min (0.30mm/t)	2,149mm/min (0.22mm/t)
切削方法 Cutting Method	平面加工 Face Milling	
切込深さ Depth of Cut	ap=0.4mm (0.025Dc) ae=8mm (0.5Dc)	
工具突出し長 Overhang Length	112mm (L/D=7)	
切削油剤 Coolant	なし(エアブロー) Air Blow	
使用機械 Machine	立形マシニングセンタ(BT40) Vertical Machining Center	

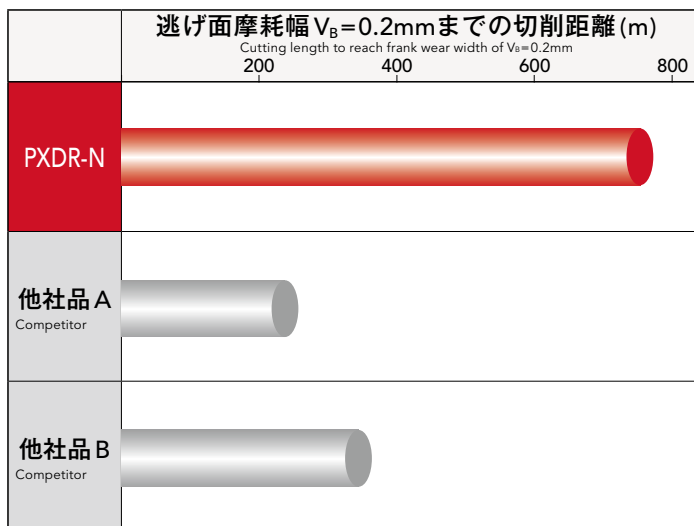

PXDR-Nは他社品の2倍以上の耐久性能が得られた。

PXDR-N was capable to achieve twice the durability versus the competition.

Cutting Data

加工データ Cutting Data

[PXSH] 65HRCの高硬度鋼において、安定した耐久性を実現 Achieves stable durability in high hardness steel of 65 HRC

使用工具 Tool	ヘッド : PXSH160C16-06R000 Head ホルダ : PXMZ-C16SS16-S100 Holder
サイズ Size	φ16
被削材 Work Material	SKH51(65HRC)
切削方法 Milling Method	側面切削 Side Milling
切削速度 Cutting Speed	60m/min (1,190min ⁻¹)
送り速度 Feed	685mm/min (0.096mm/t)
切込深さ Depth of Cut	ap=14.4mm ae=0.32mm
突出し長さ Overhang Length	48mm(L/D=3)
切削油剤 Coolant	エアブロー Air Blow
使用機械 Machine	立形マシニングセンタ (BT40) Vertical Machining Center

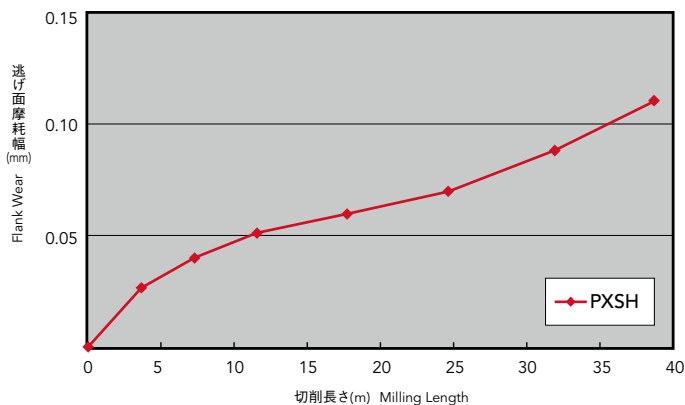

38.5m加工後の刃先の損傷状態

Wear condition of the cutting edge after milling 38.5m

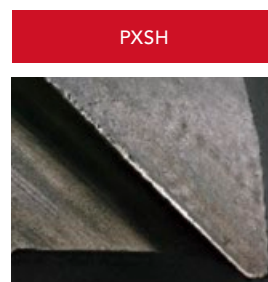

[PXSH] L/D=4で高硬度鋼の高速加工において安定した摩耗推移 Stable wear transition in high-speed machining of high-hardness steel at L/D = 4

使用工具 Tool	ヘッド : PXSH160C16-06R000 Head ホルダ : PXMZ-C16SS16-S090CS Holder	他社品 Competitor
サイズ Size	φ16	
被削材 Work Material	SKD11(60HRC)	
加工方法 Milling Method	側面切削 Side Milling	
切削速度 Cutting Speed	105m/min (2,090min ⁻¹)	
送り速度 Feed	1,130mm/min (0.09mm/t)	
切込深さ Depth of Cut	ap=14.4mm ae=0.24mm	
突出し長さ Overhang Length	64mm(L/D=4)	
切削油剤 Coolant	エアブロー Air Blow	
使用機械 Machine	立形マシニングセンタ (BT50) Vertical Machining Center	

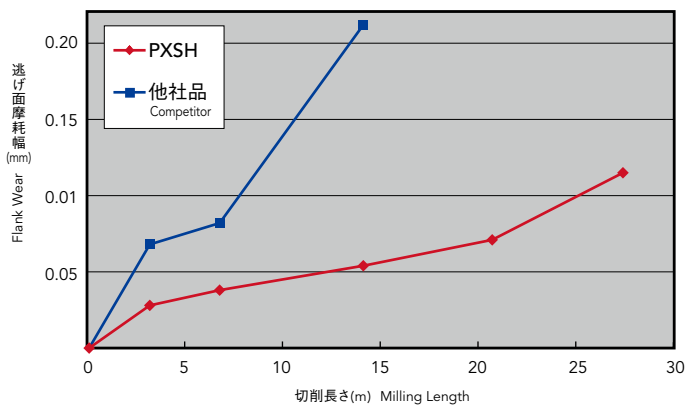

刃先の損傷状態

Wear condition of the cutting edge

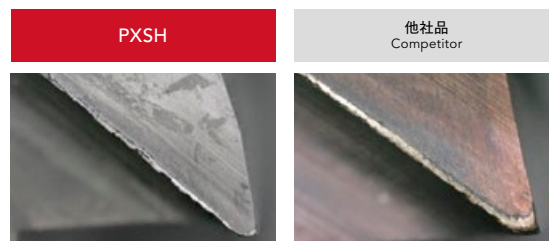

切削長さ 28m
Milling Length

切削長さ 14m
Milling Length

[PXHF-AM] SKH51 (65HRC) での加工事例 Machining example in SKH51 (65 HRC)

使用工具 Tool	ヘッド: PXHF-AM160C16-06R200-O Head ホルダ: PXMZ-C16SS16-S100-O Holder	他社品 A,B Competitor
サイズ Size	φ16 6刃 Flutes	φ16 4刃 Flutes
被削材 Work Material	SKH51(65HRC)	
切削方法 Milling Method	正面切削 Frontal Milling	
切削速度 Cutting Speed	60m/min (1,200min ⁻¹)	
送り速度 Feed	1,440mm/min (0.2mm/t)	1,440mm/min(0.3mm/t)
切込深さ Depth of Cut	ap=0.3mm ae=8mm	
切削油剤 Coolant	エアブロー Air Blow	
使用機械 Machine	立形マシニングセンタ (BT40) Vertical Machining Center	

SKH51(65HRC)の加工において、他社品と比べ4倍以上の耐久性が得られた。

Four times the durability was achieved versus the competitor products in the machining of SKH51 (65 HRC).

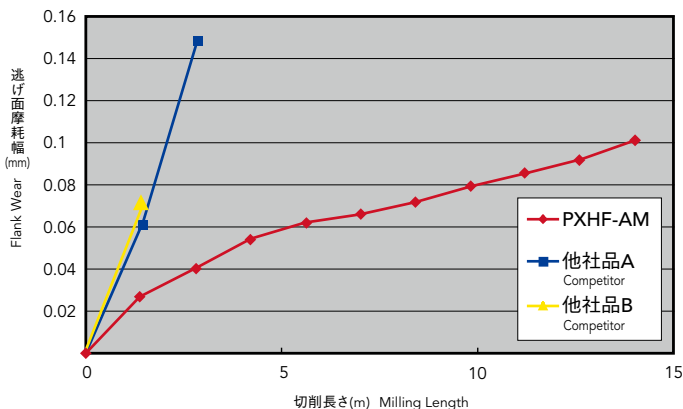

コーナR部の損耗状態

Worn state of corner R

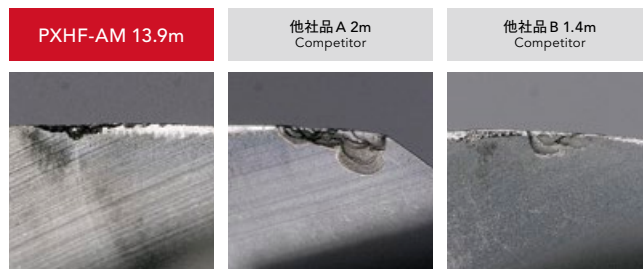

[PXBE-P] 工具突出し長の長い複雑形状加工においては3枚刃仕様のPXBE-Pが有利 The 3-flutes PXBE-P was more capable versus 4-flutes in machining work with complicated shape

使用工具 Tool	ヘッド: PXBE160C16-03R080-P Head ホルダ: PXMZ-C16SS16-L130CS Holder	他社品 A, B Competitor
サイズ Size	R8 3刃 Flutes	R8 4刃 Flutes
被削材 Work Material	SKD61 (40HRC)	
切削速度 Cutting Speed	75m/min (1,492min ⁻¹)	
送り速度 Feed	224mm/min (0.05mm/t)	298mm/min (0.05mm/t)
切込深さ Depth of Cut	ap=0.8mm (0.05Dc) ae=2.4mm (0.15Dc)	
工具突出し長 Overhang Length	78mm (L/D=4.9)	
切削油剤 Coolant	なし(エアブロー) Air Blow	
使用機械 Machine	立形マシニングセンタ (BT40) Vertical Machining Center	

鋭角パスとなる加工においては3枚刃であるPXBE-Pがびびりにくく、工具損傷が少ない。

The 3-flutes PXBE-P was less damaged versus the competitors' 4-flutes tool by machining work required paths with acute angles.

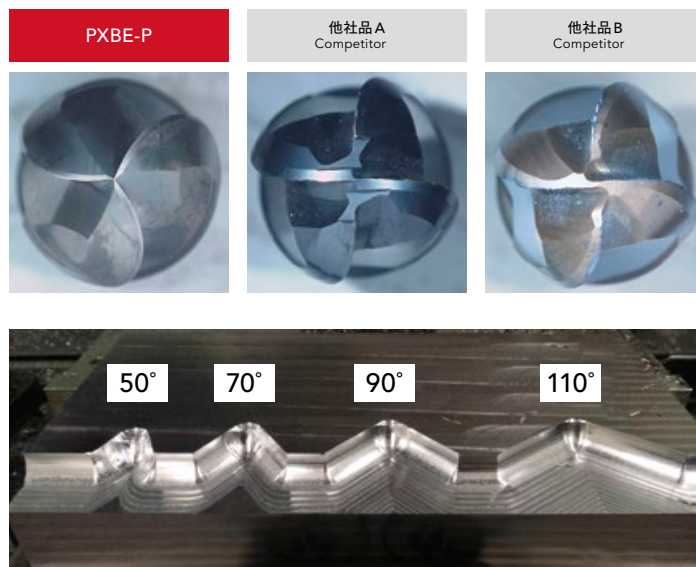

Cutting Data

加工データ Cutting Data

【PXBE-N】ソリッドからの置き換えで工具費削減 ~金型加工~ Tooling cost reduced by switching from solid tools in die casting machining

使用工具 Tool	ヘッド: PXBE160C16-03R080-N Head ホルダ: PXMZ-C16SS16-L130CS Holder	他社超硬ソリッド工具 Competitor's solid carbide tool
サイズ Size	R8 3刃 Flutes	R8 4刃 Flutes
加工ワーク Work	プレス金型 Press Dies	
被削材 Work Material	SKD11 (60HRC)	
切削速度 Cutting Speed	90m/min (1,800min ⁻¹)	
送り速度 Feed	810mm/min (0.15mm/t)	810mm/min (0.11mm/t)
切削方法 Cutting Method	ピック加工 Pick Milling	
切込深さ Depth of Cut	ap=0.32mm ae=0.8mm	
切削油剤 Coolant	水溶性切削油剤 Water-Soluble	
使用機械 Machine	立形マシニングセンタ(BT40) Vertical Machining Center	
切削長さ Milling Length	330m	

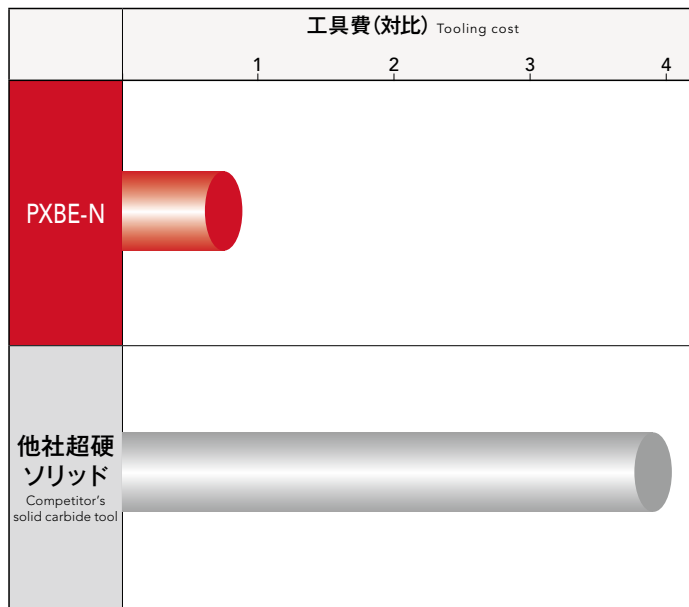

切削長さ330m、ソリッドと同等の加工能率を実現。工具費は1/4となった。
PXBE-N achieved the same machining efficiency and the cutting length of 330m as the solid end mill.

【PXBE-N】インデキサブルからの置き換えで能率UP ~溶接部加工~ Machining efficiency improved by switching from indexable tools in welding parts machining

使用工具 Tool	ヘッド: PXBE200C20-03R100-N Head ホルダ: PXMZ-C20SS20-L150CS Holder	他社インデキサブル 仕上げボールエンドミル Competitor's indexable finishing ball nose end mill
サイズ Size	R10 3刃 Flutes	R10 2刃 Flutes
加工ワーク Work	ダイカスト金型 Die-casting Die	
被削材 Work Material	SKD61 (52HRC)+溶接肉盛 Weld overlay	
切削速度 Cutting Speed	75m/min (1,200min ⁻¹)	
送り速度 Feed	420mm/min (0.12mm/t)	420mm/min (0.17mm/t)
切削方法 Cutting Method	ピック加工 Pick Milling	
切込深さ Depth of Cut	ap=10mm ae=1mm	
切削油剤 Coolant	なし(エアブロー) Air Blow	
使用機械 Machine	横形マシニングセンタ(BT50) Horizontal Machining Center	

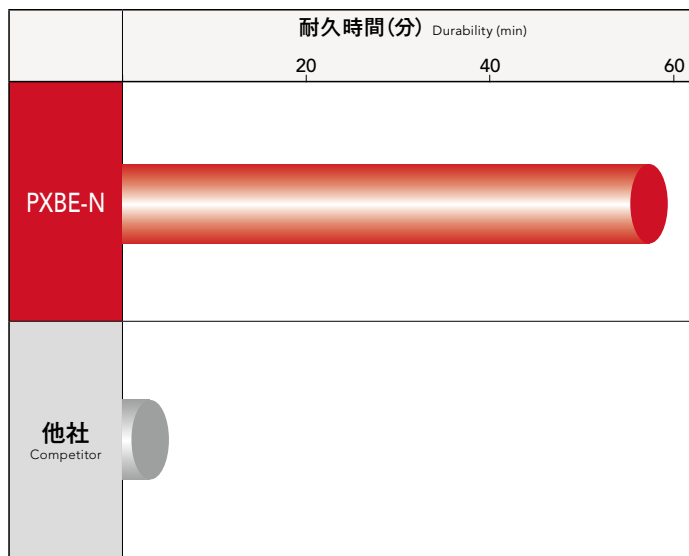

他社インデキサブルに対し、12倍の耐久が得られた。工具交換頻度も抑えられ、大幅な能率UPが可能となった。

Twelve times durability was achieved than the competitor indexable tool. Machining efficiency was highly improved, which was partly due to the shortened tool-change time.

[PXBM] NAK80の傾斜面加工(刃当り送り固定での比較) NAK80 machining at slope surface (comparison in the same feed rate)

使用工具 Tool	ヘッド : PXBM160C16-06R080 Head ホルダ : PXMZ-C16SS16-S100 Holder
サイズ Size	R8 6刃 Flutes
被削材 Work Material	NAK80 (40HRC)
切削速度 Cutting Speed	200m/min (3,980min ⁻¹)
1刃当たりの送り量 Feed Per Tooth	0.12mm/t
切削方法 Cutting Method	ピック加工 Pick Milling
切込深さ Depth of Cut	ap=0.32mm Pf=0.8mm
切削油剤 Coolant	なし(エアブロー) Air Blow
使用機械 Machine	横形マシニングセンタ(BT50) Horizontal Machining Center

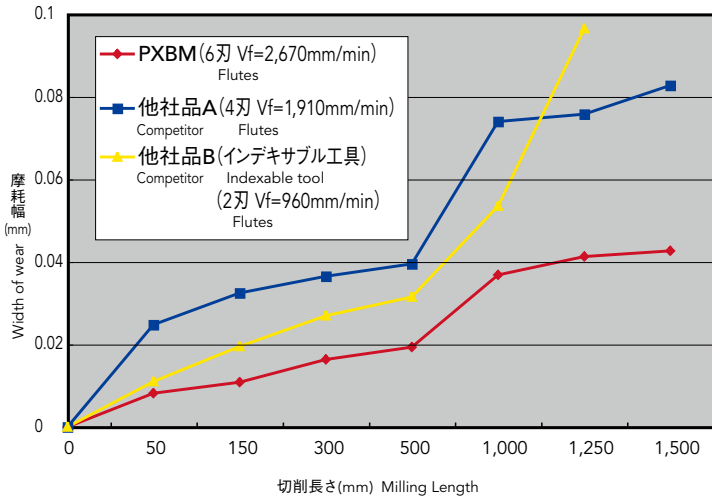

刃数メリットによる能率のアップ、優れた耐久性により高寿命が実現した。
 Materialized by more cutting edges for better productivity, longer tool life with superb durability.

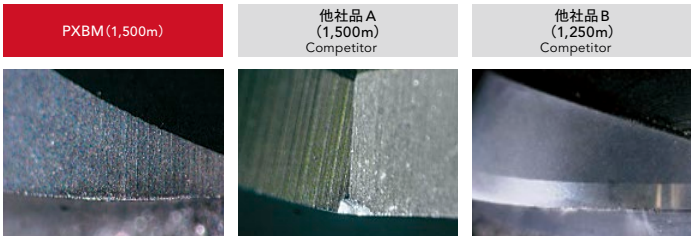

■ 締付け手順 Tightening procedure



- ① 清掃** Cleaning
ヘッド、シャンク締結部のゴミ、汚れを落とす
Remove dirt and chips from the connecting thread and shank
- ② 仮締め** Initial Tightening
手締め
Tighten by hand
- ③ 本締め** Final Tightening
専用スパナで締める
Tighten with a spanner wrench
- ④ 確認** Confirmation
隙間が無い事を確認
Confirm that there is no gap

使用上の注意
Cautions during use

- ・ヘッド装着時はPXM専用スパナをご使用下さい(市販スパナはご使用できません)。
- ・推奨締付けトルクはp.267を参照下さい。
- ・ヘッドとシャンクホルダの端面が付くまで締め込んで下さい。隙間が無い事をご確認下さい。
- ・締結部を脱脂すると締付けが固くなり、端面が付かなくなる可能性があります。脱脂はしないで下さい。
- ・スパナはヘッドの切欠きに合わせ挿入し、回転方向にゆっくりと回転させてご使用下さい。
- ・ Only use the spanner wrenches that are designed specifically for the PXM (p.267) for attaching PXM heads. Please do not use alternative spanner wrenches sold on the market as a replacement.
- ・ Please refer to p.267 for tightening torque.
- ・ Please tighten until the head and the shank holder faces meet. Confirm that there is no gap.
- ・ Degreasing the connecting thread may result in over tightening or a possible separation of the faces. Please do not degrease.
- ・ Please make sure that the spanner wrench is inserted properly and turn it slowly during use.

Phoenix PXMC

ヘッド交換式エンドミル PXM 専用コレット
Collet for PXM Exchangeable Head End Mill

PXMC



■ 特長

Features

■ PXMC コレット特長

PXMC Collet Features

- **小型マシニングセンタでも
成し得た驚きの切りくず排出量**
Powerful chip evacuation even on small machining center
- **短い突出しが可能にした、
剛性UPと理想の回転バランス**
The reduction of overhang length improves rigidity and rotational balance
- **豊富なヘッドバリエーション**
 - ・スチール、ステンレス、アルミに対応
 - ・荒から仕上げまで幅広い加工を可能に

A wide variety of exchangeable heads
· Suitable for steel, stainless steel and aluminum
· Wide processing range from roughing to finishing
- **一体型ホルダに比べ、トラブル時も
コレットの交換のみで
高いコストパフォーマンス**
Greater cost performance compared to monoblock type holders,
only need to change the collet in case of trouble.

〈PXMC エキストラショートタイプ〉 〈従来組合せ〉
PXMC Collet Extra Short Type Conventional Combination

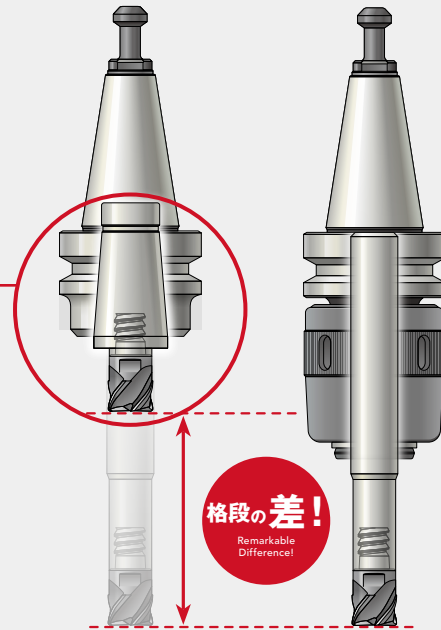

■ PXM ヘッド特長

PXM Exchangeable Head Features

ソリッドエンドミルの設計・実績・ ノウハウを活かした刃形

・様々な加工に対応可能

All the knowledge and know-how acquired by designing solid carbide end mills are found in these exchangeable heads.
· Various types are available to meet various machining methods.

端面 + テーパー = 二面拘束

- ・高い剛性と精度を確保
- ・外周刃の振れ精度：0.015mm 以下
- ・ヘッド交換精度(軸方向) ±0.03mm

End Face + Taper = Double Face Clamping
· High rigidity and accuracy of tightening
· High precision of run out ≤0.015mm
· High head replacing accuracy = ±0.03mm

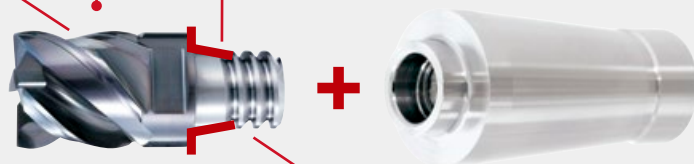

バットレスネジ採用

- ・ヘッドの脱着が容易に
- ・工具交換時間の短縮

Applying buttress screw makes easy and reduces time to desorb heads

Specification

■形状寸法表 Specification

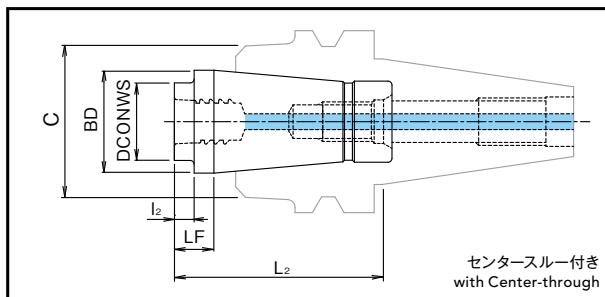

ショート
Short



エキストラショート
Extra Short

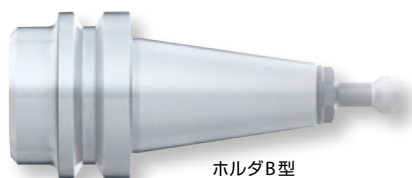

ホルダB型
Holder Type B

単位:mm Unit:mm

タイプ Type	ツールNo. EDP No.	呼び Designation	首径 DCONWS	BD	LF	首下長 L ₂	ヘッド取付時の有効長 Head + L ₂			締結規格 C _s	標準価格 (Yen)
							PXVC、PXAL、 PXSH以外*1 Except PXVC, PXAL, PXSH	PXVC、PXAL、PXSH外径 DC φ12、16、20、25	φ14、18、22 (刃太タイプ) Reduced Shank Type		
エキストラショート Extra Short	7834001	PXMC-C1205	11.7	26	10.5	5	19.4	23	25	C12	13,600
	7834002	PXMC-C1605	15.7	26	10.5	5	23.7	28.5	30.5	C16	13,600
	7834003	PXMC-C2005	19.6	26	10.5	5	26.5	32.5	34.5	C20	13,600
	7834004	PXMC-C2505	24	26	10.5	5	32.5	40	—	C25	13,600
ショート Short	7834011	PXMC-C1230	11.7	26	35.5	30	44.4	48	50	C12	14,500
	7834012	PXMC-C1630	15.7	26	35.5	30	48.7	53.5	55.5	C16	14,500
	7834013	PXMC-C2030	19.6	26	35.5	30	51.5	57.5	59.5	C20	14,500
	7834014	PXMC-C2530	24	26	35.5	30	57.5	65	—	C25	14,500

- PXMCは「OSG PHOENIX PXMシリーズ」のヘッド専用コレットです。
- *1: 取り付け可能ヘッド: PXNH、PXNL、PXSE、PXSM、PXDR、PXRE、PXHF-AM、PXBE、PXBM
 - The PXMC exchangeable head is designed specifically for the "OSG PHOENIX PXM" series.
 - Applicable exchangeable heads: PXNH, PXNL, PXSE, PXSM, PXDR, PXRE, PXHF-AM, PXBE, PXBM.

■PXMC対応ハイプロシュリンクシステム 製品一覧 Product Listing of PXMC corresponding to the HYPRO Shrink System

単位:mm Unit:mm

タイプ Type	ツールNo. EDP No.	呼び Designation	C	L ₂	
				エキストラショート Extra Short	ショート Short
ホルダB型 Holder Type B	8910000	BT30-SLK12-35 P30T-1(MAS1)*2	38	45.5	70.5
	8910001	BT30-SLK12-35 P30T-2(MAS2)*2	38	45.5	70.5
	8910002	BT40-SLK12-45	38	55.5	80.5
	8910003	BT40-SLK12-75	38	85.5	110.5
	8910005	A63-SLK12-75	38	85.5	110.5
	8910006	A63-SLK12-135	38	145.5	170.5

- 価格は当社営業まで問合せ下さい。
- PXMC コレットはハイプロシュリンクコレットシステムと互換性があります。
- *2: BT30用ホルダのみプルスタッドボルトが付属します。
 - Contact your local OSG sales representative for information regarding pricing.
 - The PXMC collet is compatible with the HYPRO Shrink Collet System.
 - *2: Only BT30 holders come with a pull stud bolt.

在庫区分は全てC(標準在庫品)となります。 Stock are categorized as C (Standard stock item).

Phoenix PXMC

ヘッド交換式エンドミル

Exchangeable Head End Mill

PXVC + PXMC

Cutting Conditions

■ 切削条件基準表 Cutting Conditions

側面切削 PXVC + PXMC エキストラショートタイプ Side Milling, PXVC+PXMC Extra Short Type

被削材 Work Material	一般構造用鋼・炭素鋼・鋳鉄 Mild Steel・Carbon Steel Cast Iron SS400, S55C, FC250 (~750N/mm ²)		合金鋼・工具鋼 Alloy Steel Tool Steel SCM, SKT, SKS, SKD (~30HRC)		ステンレス鋼・調質鋼 Stainless Steel Hardened Steel SUS304, SKD (~45HRC)		調質鋼・チタン合金(湿式) Hardened Steel Titanium Alloy (Wet) Ti-6Al-4V (45 ~ 55HRC)	
	回転速度 Speed (min ⁻¹)	送り速度 Feed (mm/min)	回転速度 Speed (min ⁻¹)	送り速度 Feed (mm/min)	回転速度 Speed (min ⁻¹)	送り速度 Feed (mm/min)	回転速度 Speed (min ⁻¹)	送り速度 Feed (mm/min)
10	6,690	2,070	5,350	1,650	4,460	1,240	3,320	870
12	5,580	1,720	4,460	1,380	3,720	1,030	2,760	720
14	4,780	1,480	3,820	1,180	3,190	890	2,370	620
16	4,180	1,290	3,350	1,040	2,790	780	2,070	540
18	3,720	1,150	2,980	920	2,480	690	1,840	480
20	3,350	1,040	2,680	830	2,230	620	1,660	440
22	3,040	940	2,440	760	2,030	570	1,510	400
25	2,680	830	2,140	660	1,790	500	1,330	350
32	標準シャンクとの組合せでは、最長でもL/D=5までとなります Maximum length of L/D=5 in combination with the standard shank							
切込深さ Depth of Cut	ap=0.5DC ae=0.25DC				ap=0.5DC ae=0.12DC		ap=0.5DC ae=0.075DC	

側面切削 PXVC + PXMC ショートタイプ Side Milling, PXVC+PXMC Short Type

被削材 Work Material	一般構造用鋼・炭素鋼・鋳鉄 Mild Steel・Carbon Steel Cast Iron SS400, S55C, FC250 (~750N/mm ²)		合金鋼・工具鋼 Alloy Steel Tool Steel SCM, SKT, SKS, SKD (~30HRC)		ステンレス鋼・調質鋼 Stainless Steel Hardened Steel SUS304, SKD (~45HRC)		調質鋼・チタン合金(湿式) Hardened Steel Titanium Alloy (Wet) Ti-6Al-4V (45 ~ 55HRC)	
	回転速度 Speed (min ⁻¹)	送り速度 Feed (mm/min)	回転速度 Speed (min ⁻¹)	送り速度 Feed (mm/min)	回転速度 Speed (min ⁻¹)	送り速度 Feed (mm/min)	回転速度 Speed (min ⁻¹)	送り速度 Feed (mm/min)
10	5,730	1,490	4,590	1,200	3,820	970	2,550	750
12	4,780	1,250	3,820	1,000	3,190	810	2,130	630
14	4,100	1,070	3,280	860	2,730	690	1,820	540
16	3,590	940	2,870	750	2,390	610	1,600	470
18	3,190	830	2,550	670	2,130	540	1,420	420
20	2,870	750	2,300	600	1,910	490	1,280	380
22	2,610	680	2,090	550	1,740	440	1,160	340
25	2,300	600	1,840	480	1,530	390	1,020	300
32	標準シャンクとの組合せでは、最長でもL/D=5までとなります Maximum length of L/D=5 in combination with the standard shank							
切込深さ Depth of Cut	ap=0.5DC ae=0.2DC				ap=0.5DC ae=0.1DC		ap=0.5DC ae=0.05DC	

1. 切込深さ、機械剛性等使用状況により、回転速度、送り速度を調整下さい。

1. Please adjust speed and feed when the depth of cut is large or machines with low rigidity are used.

溝切削 PXVC + PXMC エキストラショートタイプ Slot Milling, PXVC+PXMC Extra Short Type

被削材 Work Material	一般構造用鋼・炭素鋼・鋳鉄 Mild Steel・Carbon Steel Cast Iron SS400, S55C, FC250 (~750N/mm ²)		合金鋼・工具鋼 Alloy Steel Tool Steel SCM, SKT, SKS, SKD (~30HRC)		ステンレス鋼・調質鋼 Stainless Steel Hardened Steel SUS304, SKD (~45HRC)		調質鋼・チタン合金(湿式) Hardened Steel Titanium Alloy (Wet) Ti-6Al-4V (45~55HRC)	
	外径 DC	回転速度 Speed (min ⁻¹)	送り速度 Feed (mm/min)	回転速度 Speed (min ⁻¹)	送り速度 Feed (mm/min)	回転速度 Speed (min ⁻¹)	送り速度 Feed (mm/min)	回転速度 Speed (min ⁻¹)
10	5,730	1,450	4,620	1,170	3,820	770	2,620	530
12	4,780	1,210	3,850	980	3,190	640	2,180	440
14	4,100	1,040	3,300	840	2,730	550	1,870	380
16	3,590	910	2,890	730	2,390	480	1,640	330
18	3,190	810	2,570	650	2,130	430	1,460	300
20	2,870	730	2,310	590	1,910	390	1,310	270
22	2,610	660	2,100	530	1,740	350	1,190	240
25	2,300	580	1,850	470	1,530	310	1,050	210
32	標準シャンクとの組合せでは、最長でもL/D=5までとなります Maximum length of L/D=5 in combination with the standard shank							
切込深さ Depth of Cut	ap ≤ 0.5DC		ap ≤ 0.4DC		ap ≤ 0.3DC			

溝切削 PXVC + PXMC ショートタイプ Slot Milling, PXVC+PXMC Short Type

被削材 Work Material	一般構造用鋼・炭素鋼・鋳鉄 Mild Steel・Carbon Steel Cast Iron SS400, S55C, FC250 (~750N/mm ²)		合金鋼・工具鋼 Alloy Steel Tool Steel SCM, SKT, SKS, SKD (~30HRC)		ステンレス鋼・調質鋼 Stainless Steel Hardened Steel SUS304, SKD (~45HRC)		調質鋼・チタン合金(湿式) Hardened Steel Titanium Alloy (Wet) Ti-6Al-4V (45~55HRC)	
	外径 DC	回転速度 Speed (min ⁻¹)	送り速度 Feed (mm/min)	回転速度 Speed (min ⁻¹)	送り速度 Feed (mm/min)	回転速度 Speed (min ⁻¹)	送り速度 Feed (mm/min)	回転速度 Speed (min ⁻¹)
10	4,780	1,250	3,820	970	3,190	770	2,390	480
12	3,980	1,040	3,190	810	2,660	640	1,990	400
14	3,420	890	2,730	690	2,280	550	1,710	350
16	2,990	780	2,390	610	1,990	480	1,500	300
18	2,660	700	2,130	540	1,770	430	1,330	270
20	2,390	630	1,910	490	1,600	390	1,200	240
22	2,180	570	1,740	440	1,450	350	1,090	220
25	1,910	500	1,530	390	1,280	310	960	200
32	標準シャンクとの組合せでは、最長でもL/D=5までとなります Maximum length of L/D=5 in combination with the standard shank							
切込深さ Depth of Cut	ap ≤ 0.5DC		ap ≤ 0.4DC		ap ≤ 0.3DC			

1. 切込深さ、機械剛性等使用状況により、回転速度、送り速度を調整下さい。

1. Please adjust speed and feed when the depth of cut is large or machines with low rigidity are used.

Phoenix PXMC

スクエア・コーナラジラス形状

Square - Corner Radius Type

PXAL + PXMC

Cutting Conditions

■切削条件基準表 Cutting Conditions

PXAL + PXMC エキストラショートタイプ PXAL+PXMC Extra Short Type

側面切削 Side Milling

被削材 Work Material	アルミニウム合金展伸材 Aluminum Alloy Expanding Material A5052, A7075	
外径 DC	回転速度 Speed (min ⁻¹)	送り速度 Feed (mm/min)
12	10,000	3,000
14	10,000	3,000
16	10,000	3,000
18	8,900	3,210
20	8,000	2,880
22	7,300	3,510
25	6,400	3,080
切込深さ Depth of Cut	ap=0.7D ae=0.2D	

溝切削 Slot Milling

被削材 Work Material	アルミニウム合金展伸材 Aluminum Alloy Expanding Material A5052, A7075	
外径 DC	回転速度 Speed (min ⁻¹)	送り速度 Feed (mm/min)
12	10,000	3,000
14	10,000	3,000
16	10,000	3,000
18	8,900	2,670
20	8,000	2,400
22	7,300	2,190
25	6,400	1,920
切込深さ Depth of Cut	ap=0.5D	

PXAL + PXMC ショートタイプ PXAL+PXMC Short Type

側面切削 Side Milling

被削材 Work Material	アルミニウム合金展伸材 Aluminum Alloy Expanding Material A5052, A7075	
外径 DC	回転速度 Speed (min ⁻¹)	送り速度 Feed (mm/min)
12	10,000	2,700
14	10,000	2,700
16	10,000	2,700
18	8,900	2,890
20	8,000	2,600
22	7,300	3,160
25	6,400	2,770
切込深さ Depth of Cut	ap=0.7D ae=0.2D	

溝切削 Slot Milling

被削材 Work Material	アルミニウム合金展伸材 Aluminum Alloy Expanding Material A5052, A7075	
外径 DC	回転速度 Speed (min ⁻¹)	送り速度 Feed (mm/min)
12	10,000	2,700
14	10,000	2,700
16	10,000	2,700
18	8,900	2,410
20	8,000	2,160
22	7,300	1,980
25	6,400	1,730
切込深さ Depth of Cut	ap=0.5D	

1. 切込深さ、機械剛性等使用状況により、回転速度、送り速度を調整下さい。

2. 銅・銅合金切削時は、上表の回転速度20～40%、送り速度50～80%、切込み深さ(ap) 50～80%程度に下げてご使用下さい。

3. マグネシウム合金切削時は、アルミニウム合金展伸材と同条件でご使用下さい。切削油剤を使用する場合は切削油剤メーカーの推奨するものを必ずご使用下さい。

また、切りくずの処理・管理にご注意下さい。発火の恐れがあります。

1. Please adjust speed and feed when the depth of cut is large or machines with low rigidity are used.

2. When milling copper and copper alloys, lower the rotational speed by 20 to 40%, feed rate by 50 to 80%, and cutting depth by ap 50 to 80% in accordance with the table above.

3. Please always use the appropriate cutting fluid recommended by the cutting fluid manufacturer in the machining of magnesium alloys. Be cautious with the cutting chips as they are highly flammable and may pose a serious fire risk if not properly handled.

Phoenix PPMC

ヘッド交換式エンドミル
Exchangeable Head End Mill

PXNH + PPMC

Cutting Conditions

■ 切削条件基準表 Cutting Conditions

側面切削 PXNH + PPMC エキストラショートタイプ Side Milling, PXNH+PPMC Extra Short Type

被削材 Work Material	鋳鉄 Cast Iron FC250		炭素鋼 Carbon Steel		合金鋼 Alloy Steel		調質鋼・プリハードン鋼(快削) Hardened Steel Pre-hardened Steel (Free-Cutting) (~45HRC)		ステンレス鋼 Stainless Steel SUS304		
	外径 DC	回転速度 Speed (min ⁻¹)	送り速度 Feed (mm/min)	回転速度 Speed (min ⁻¹)	送り速度 Feed (mm/min)	回転速度 Speed (min ⁻¹)	送り速度 Feed (mm/min)	回転速度 Speed (min ⁻¹)	送り速度 Feed (mm/min)	回転速度 Speed (min ⁻¹)	送り速度 Feed (mm/min)
	10	5,160	1,440	6,840	1,670	5,720	1,060	4,300	520	3,050	320
	12	4,300	1,200	5,700	1,400	4,770	880	3,580	430	2,540	270
	16	3,220	1,240	4,280	1,430	3,580	900	2,680	450	1,900	280
	20	2,570	1,320	3,420	1,520	2,860	960	2,140	460	1,520	300
	25	1,600	900	2,290	1,120	1,830	680	1,330	330	910	200
	32	標準シャンクとの組合せでは、最長でもL/D=5までとなります Maximum length of L/D=5 in combination with the standard shank									
切込深さ Depth of Cut	ap=0.5DC ae=0.4DC						ap=0.5DC ae=0.3DC		ap=0.5DC ae=0.2DC		

側面切削 PXNH + PPMC ショートタイプ Side Milling, PXNH+PPMC Short Type

被削材 Work Material	鋳鉄 Cast Iron FC250		炭素鋼 Carbon Steel		合金鋼 Alloy Steel		調質鋼・プリハードン鋼(快削) Hardened Steel Pre-hardened Steel (Free-Cutting) (~45HRC)		ステンレス鋼 Stainless Steel SUS304		
	外径 DC	回転速度 Speed (min ⁻¹)	送り速度 Feed (mm/min)	回転速度 Speed (min ⁻¹)	送り速度 Feed (mm/min)	回転速度 Speed (min ⁻¹)	送り速度 Feed (mm/min)	回転速度 Speed (min ⁻¹)	送り速度 Feed (mm/min)	回転速度 Speed (min ⁻¹)	送り速度 Feed (mm/min)
	10	4,300	1,300	5,720	1,510	4,760	950	3,720	410	3,300	300
	12	3,580	1,080	4,770	1,260	3,970	790	3,100	340	2,750	250
	16	2,680	1,110	3,580	1,290	2,980	810	2,320	360	2,060	260
	20	2,140	1,180	2,860	1,360	2,380	860	1,850	370	1,650	270
	25	1,330	810	1,900	1,000	1,530	610	1,150	260	980	180
	32	標準シャンクとの組合せでは、最長でもL/D=5までとなります Maximum length of L/D=5 in combination with the standard shank									
切込深さ Depth of Cut	ap=0.5DC ae=0.4DC						ap=0.5DC ae=0.3DC		ap=0.5DC ae=0.2DC		

1. 切込深さ、機械剛性等使用状況により、回転速度、送り速度を調整下さい。
1. Please adjust speed and feed when the depth of cut is large or machines with low rigidity are used.

Phoenix P X M C

ヘッド交換式エンドミル

Exchangeable Head End Mill

PXNH + PXMC

溝切削 PXNH + PXMC エキストラショートタイプ Slot Milling, PXNH+PXMC Extra Short Type

被削材 Work Material	鋳鉄 Cast Iron FC250		炭素鋼 Carbon Steel		合金鋼 Alloy Steel		調質鋼・プリハードン鋼(快削) Hardened Steel Pre-hardened Steel (Free-Cutting) (~45HRC)		ステンレス鋼 Stainless Steel SUS304		
	外径 DC	回転速度 Speed (min ⁻¹)	送り速度 Feed (mm/min)	回転速度 Speed (min ⁻¹)	送り速度 Feed (mm/min)	回転速度 Speed (min ⁻¹)	送り速度 Feed (mm/min)	回転速度 Speed (min ⁻¹)	送り速度 Feed (mm/min)	回転速度 Speed (min ⁻¹)	送り速度 Feed (mm/min)
	10	4,460	1,260	6,360	1,550	5,090	920	3,560	260	2,660	190
	12	3,720	1,050	5,300	1,290	4,240	770	2,970	220	2,220	160
	16	2,780	1,120	3,980	1,400	3,180	840	2,220	240	1,660	180
	20	2,070	1,040	2,980	1,320	2,380	800	1,590	220	1,210	160
	25	1,520	980	2,300	1,290	1,780	730	1,210	200	890	150
	32	標準シャンクとの組合せでは、最長でもL/D=5までとなります Maximum length of L/D=5 in combination with the standard shank									
切込深さ Depth of Cut	$a_p \leq 0.5DC$										

溝切削 PXNH + PXMC ショートタイプ Slot Milling, PXNH+PXMC Short Type

被削材 Work Material	鋳鉄 Cast Iron FC250		炭素鋼 Carbon Steel		合金鋼 Alloy Steel		調質鋼・プリハードン鋼(快削) Hardened Steel Pre-hardened Steel (Free-Cutting) (~45HRC)		ステンレス鋼 Stainless Steel SUS304		
	外径 DC	回転速度 Speed (min ⁻¹)	送り速度 Feed (mm/min)	回転速度 Speed (min ⁻¹)	送り速度 Feed (mm/min)	回転速度 Speed (min ⁻¹)	送り速度 Feed (mm/min)	回転速度 Speed (min ⁻¹)	送り速度 Feed (mm/min)	回転速度 Speed (min ⁻¹)	送り速度 Feed (mm/min)
	10	3,350	1,080	4,760	1,330	3,820	790	2,890	230	2,280	170
	12	2,790	900	3,970	1,110	3,180	660	2,410	190	1,900	140
	16	2,080	960	2,980	1,200	2,380	720	1,800	210	1,420	150
	20	1,470	890	2,190	1,150	1,800	760	1,310	200	1,020	140
	25	1,140	840	1,720	1,110	1,330	630	980	180	760	130
	32	標準シャンクとの組合せでは、最長でもL/D=5までとなります Maximum length of L/D=5 in combination with the standard shank									
切込深さ Depth of Cut	$a_p \leq 0.5DC$										

1. 切込深さ、機械剛性等使用状況により、回転速度、送り速度を調整下さい。

1. Please adjust speed and feed when the depth of cut is large or machines with low rigidity are used.

Phoenix PXMC

スクエア形状

Square Type

PXSH + PXMC

Cutting Conditions

■ 切削条件基準表 Cutting Conditions

PXSH + PXMC 側面切削 Side Milling $L/D \leq 4$

被削材 Work Material	調質鋼 (~45HRC)・ プリハードン鋼 Hardened Steel・Prehardened Steel SCM, SKD61, NAK80		調質鋼 Hardened Steel							
			~55HRC		~62HRC		~66HRC		~70HRC	
切削速度 Cutting Speed (m/min)	110~130		80~100		60~80		50~70		40~60	
外径 DC	回転速度 Speed (min ⁻¹)	送り速度 Feed (mm/min)	回転速度 Speed (min ⁻¹)	送り速度 Feed (mm/min)	回転速度 Speed (min ⁻¹)	送り速度 Feed (mm/min)	回転速度 Speed (min ⁻¹)	送り速度 Feed (mm/min)	回転速度 Speed (min ⁻¹)	送り速度 Feed (mm/min)
12	3,180	2,290	2,390	1,720	1,860	940	1,590	690	1,330	510
16	2,390	2,290	1,790	1,720	1,390	930	1,190	690	1,000	510
20	1,910	2,290	1,430	1,720	1,110	930	960	690	800	510
25	1,530	2,450	1,150	1,840	890	1,000	760	730	640	510
切込深さ Depth of Cut	 $a_p = 1D$ $a_e = 0.05D$ $a_e \text{ Max} = 1\text{mm}$		$a_p = 1D$ $a_e = 0.03D$ $a_e \text{ Max} = 1\text{mm}$		$a_p = 1D$ $a_e = 0.02D$ $a_e \text{ Max} = 0.5\text{mm}$					

PXSH + PXMC 側面切削 Side Milling $4 < L/D \leq 5$

被削材 Work Material	調質鋼 (~45HRC)・ プリハードン鋼 Hardened Steel・Prehardened Steel SCM, SKD61, NAK80		調質鋼 Hardened Steel							
			~55HRC		~62HRC		~66HRC		~70HRC	
切削速度 Cutting Speed (m/min)	75~95		55~75		40~60		35~55		25~45	
外径 DC	回転速度 Speed (min ⁻¹)	送り速度 Feed (mm/min)	回転速度 Speed (min ⁻¹)	送り速度 Feed (mm/min)	回転速度 Speed (min ⁻¹)	送り速度 Feed (mm/min)	回転速度 Speed (min ⁻¹)	送り速度 Feed (mm/min)	回転速度 Speed (min ⁻¹)	送り速度 Feed (mm/min)
12	2,260	1,630	1,730	1,250	1,330	480	1,190	340	930	200
16	1,690	1,620	1,290	1,240	1,000	480	900	350	700	200
20	1,350	1,620	1,040	1,250	800	480	720	350	560	200
25	1,080	1,730	830	1,330	640	720	570	550	450	360
切込深さ Depth of Cut	 $a_p = 1D$ $a_e = 0.03D$ $a_e \text{ Max} = 1\text{mm}$		$a_p = 1D$ $a_e = 0.02D$ $a_e \text{ Max} = 1\text{mm}$		$a_p = 0.7D$ $a_e = 0.02D$ $a_e \text{ Max} = 0.5\text{mm}$					

1. 機械、ホルダは剛性のある精度の高いものをご使用下さい。
 2. びびりが発生する時は、回転速度、送り速度を同じ割合で下げてご使用下さい。
 3. 突出し長くなる場合は、びびりが発生しやすくなりますので、回転速度、送り速度、切込深さを調整下さい。
 4. 切削条件は、ホルダ端面からのシャンクホルダ(PXMZ)の突出し長さにヘッド全長(LF)を加えた突出し長さを配慮した選定をして下さい。
 5. 切削油剤は被削材に応じてエアブローまたは発煙性の少ない切削油剤をご使用下さい。
1. Use a rigid and precise machine and holder.
 2. When chattering occurs, reduce the speed and feed simultaneously.
 3. Please adjust the cutting condition when the overhang length is longer.
 4. Please consider the overhang length as the total length of replaceable head and overhang length of shank holder.
 5. Use an air blow or a suitable cutting fluid with high smoke retardant properties.

Phoenix PXM C

スクエア形状

Square Type

PXSH + PXM C

Cutting Conditions

■切削条件基準表 Cutting Conditions

! 加工時に発生する火花や破損による発熱で引火・火災の危険性があります。
防火対策を必ず行って下さい。

高速高精度のマシニングセンタを利用した場合の基準条件表です。

Caution: Sparks generated during operation or heat caused by tool breakage can cause fire.
Be sure to use all proper fire - prevention measures.

The conditions below are for high speed / high precision machining centers.

PXSH + PXM C 高速側面切削 High-Speed Side Milling $L/D \leq 4$

被削材 Work Material	調質鋼(～45HRC)・ プリハードン鋼 Hardened Steel・Prehardened Steel SCM, SKD61, NAK80		調質鋼 Hardened Steel							
			～55HRC		～62HRC		～66HRC		～70HRC	
切削速度 Cutting Speed (m/min)	160～180		140～160		95～115		80～100		60～80	
外径 DC	回転速度 Speed (min ⁻¹)	送り速度 Feed (mm/min)	回転速度 Speed (min ⁻¹)	送り速度 Feed (mm/min)	回転速度 Speed (min ⁻¹)	送り速度 Feed (mm/min)	回転速度 Speed (min ⁻¹)	送り速度 Feed (mm/min)	回転速度 Speed (min ⁻¹)	送り速度 Feed (mm/min)
12	4,510	2,600	3,980	2,290	2,790	1,130	2,390	860	1,860	600
16	3,380	2,600	2,990	2,300	2,090	1,130	1,790	860	1,390	600
20	2,710	2,600	2,390	2,290	1,670	1,130	1,430	860	1,110	600
25	2,170	2,780	1,910	2,440	1,340	1,210	1,150	920	890	640
切込深さ Depth of Cut	 $a_p = 1D$ $a_e = 0.05D$ $a_e \text{ Max} = 1\text{mm}$		$a_p = 1D$ $a_e = 0.03D$ $a_e \text{ Max} = 1\text{mm}$		$a_p = 1D$ $a_e = 0.015D$ $a_e \text{ Max} = 0.5\text{mm}$		$a_p = 1D$ $a_e = 0.01D$ $a_e \text{ Max} = 0.2\text{mm}$			

1. 摩擦が進行すると火花が発生しますので、発火性のある切削油剤は絶対に使用しないで下さい。
 2. 機械、ホルダは剛性のある精度の高いものをご使用下さい。
 3. びびりが発生する時は、回転速度、送り速度を同じ割合で下げてご使用下さい。
 4. 切削条件は、ホルダ端面からのシャンクホルダ(PXMZ)の突出し長さにヘッド全長(LF)を加えた突出し長さを配慮した選定をして下さい。
 5. 切削油剤は被削材に応じてエアブローまたは発煙性の少ない切削油剤をご使用下さい。
1. Tools can cause sparks. Do not use flammable fluids.
 2. Use a rigid and precise machine and holder.
 3. When chattering occurs, reduce the speed and feed simultaneously.
 4. Please consider the overhang length as the total length of replaceable head and overhang length of shank holder.
 5. Use an air blow or a suitable cutting fluid with high smoke retardant properties.

Phoenix PXMC

ラジラス形状

Radius Type

PXHF-AM+ PXMC

Cutting Conditions

■ 切削条件基準表 Cutting Conditions

PXHF-AM + PXMC

・ランピング加工時の最大傾斜角(E°) Maximum Ramping Angle(E°)

呼び Designation	ランピング角度 Ramping Angle E°	ヘリカル穴あけ Helical Milling (mm)		ヘリカル角度 Helical Angle P°
		最小径 Do Min.	最大径 Do Max.	
PXHF-AM120C12-06R150-O	3°	18	23	1.5°
PXHF-AM160C16-06R200-O		24	31	
PXHF-AM200C20-06R250-O		30	39	

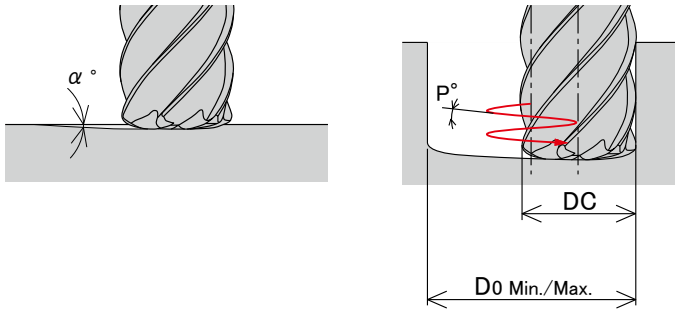

・プログラム作成上の刃先形状定義 Edge shape definitions for the purpose of creating a program

呼び Designation	擬似R rt	削り残し量 Remainder Z
PXHF-AM120C12-06R150-O	R1.5	0.36
PXHF-AM160C16-06R200-O	R2	0.47
PXHF-AM200C20-06R250-O	R2.5	0.59

加工に際しては、それぞれ擬似Rのラジラスエンドミルとして加工プログラムを作成下さい。
During machining, please program the milling paths according to the recommended simulated R (rt) respective to the individual end mill diameter.

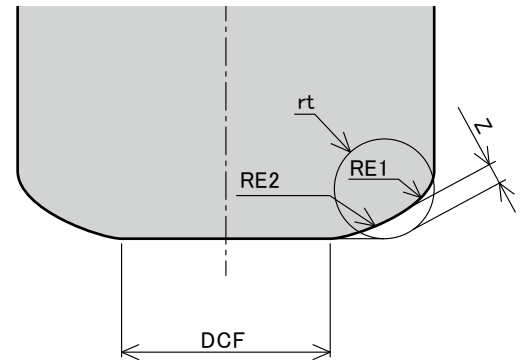

Phoenix P X M C

ラジアス形状

Radius Type

PXHF-AM+PXMC

Cutting Conditions

■切削条件基準表 Cutting Conditions

加工に際しては、それぞれ擬似Rのラジアスエンドミルとして加工プログラムを作成下さい。

During machining, please program the milling paths according to the recommended simulated R (rt) respective to the individual end mill diameter.

PXHF-AM + PXMC 正面切削 Frontal Milling $L/D \leq 4$

被削材 Work Material	調質鋼・プリハードン鋼 Hardened Steel・ Prehardened Steel		調質鋼 Hardened Steel				ステンレス鋼 Stainless Steel		コバルトクロム基 Cobalt-Chromium Based Alloy (Stellite)		チタン合金 Titanium Alloy		Ni合金 Ni-Based Alloy (Inconel 718)	
	~45HRC		~62HRC		~70HRC		≤200HB							
切削速度 Cutting Speed (m/min)	110~130		90~110		65~85		125~145		110~130		90~110		30~50	
外径 DC	回転速度 Speed (min ⁻¹)	送り速度 Feed (mm/min)	回転速度 Speed (min ⁻¹)	送り速度 Feed (mm/min)	回転速度 Speed (min ⁻¹)	送り速度 Feed (mm/min)	回転速度 Speed (min ⁻¹)	送り速度 Feed (mm/min)	回転速度 Speed (min ⁻¹)	送り速度 Feed (mm/min)	回転速度 Speed (min ⁻¹)	送り速度 Feed (mm/min)	回転速度 Speed (min ⁻¹)	送り速度 Feed (mm/min)
12	3,180	5,270	2,650	4,390	1,990	1,580	3,580	5,930	3,180	5,270	2,650	4,390	1,060	760
16	2,390	5,280	1,990	4,390	1,490	1,570	2,690	5,940	2,390	5,280	1,990	4,390	800	770
20	1,910	5,270	1,590	4,390	1,190	1,570	2,150	5,930	1,910	5,270	1,590	4,390	640	770
切込深さ Depth of Cut	<p>$a_p = \text{Max} : 0.04D$ $a_e = \text{Max} : 0.5D$</p>													

PXHF-AM + PXMC 正面切削 Frontal Milling $4 < L/D \leq 5$

被削材 Work Material	調質鋼・プリハードン鋼 Hardened Steel・ Prehardened Steel		調質鋼 Hardened Steel				ステンレス鋼 Stainless Steel		コバルトクロム基 Cobalt-Chromium Based Alloy (Stellite)		チタン合金 Titanium Alloy		Ni合金 Ni-Based Alloy (Inconel 718)	
	~45HRC		~62HRC		~70HRC		≤200HB							
切削速度 Cutting Speed (m/min)	100~120		80~100		60~80		115~135		100~120		80~100		25~45	
外径 DC	回転速度 Speed (min ⁻¹)	送り速度 Feed (mm/min)	回転速度 Speed (min ⁻¹)	送り速度 Feed (mm/min)	回転速度 Speed (min ⁻¹)	送り速度 Feed (mm/min)	回転速度 Speed (min ⁻¹)	送り速度 Feed (mm/min)	回転速度 Speed (min ⁻¹)	送り速度 Feed (mm/min)	回転速度 Speed (min ⁻¹)	送り速度 Feed (mm/min)	回転速度 Speed (min ⁻¹)	送り速度 Feed (mm/min)
12	2,920	3,780	2,390	3,100	1,860	1,210	3,320	4,300	2,920	3,780	2,390	3,100	930	540
16	2,190	3,780	1,790	3,090	1,390	1,200	2,490	4,300	2,190	3,780	1,790	3,090	700	540
20	1,750	3,780	1,430	3,090	1,110	1,200	1,990	4,300	1,750	3,780	1,430	3,090	560	540
切込深さ Depth of Cut	<p>$a_p = \text{Max} : 0.03D$ $a_e = \text{Max} : 0.5D$</p>													

1. 本工具はアディティブ・マニファクチャリング(金属積層)、金型肉盛り部表面の荒取り加工に使用することを推奨します。
2. 機械、ホルダは剛性のある精度の高いものをご使用下さい。
3. 上表の値はあくまでも目安です。実際の加工における切削条件は上表を参考に状況に応じて設定下さい。
4. 推奨条件よりも切込み量を大きくする場合は、送り速度を抑えてご使用下さい。
5. 突出し長さが長くなる場合は、びびりが発生しやすくなりますので、回転速度、送り速度、切込み深さを調整下さい。
6. 切削油剤は被削材に適したもので、発煙性の少ないものをご使用下さい。
7. 乾式の場合には、切りくず詰まりが無いようエアブローにて切りくずを除去下さい。
8. ステンレス鋼、コバルトクロム合金、チタン合金、Ni合金の加工には、水溶性切削油剤の使用を推奨します。
9. 工具の振れ精度を最小限に抑えてご使用下さい。
10. コーナ部等切削負荷が変動する場合は、回転速度を抑えてご使用下さい。
11. ピック量が0.5D以上の場合、加工面にカスプが発生することがあります。

1. This tool is recommended for the roughing of additive manufacturing and mold overlay surfaces.
2. Please use machines and holders that are rigid and highly accurate.
3. The values listed above are for reference. Please set the cutting condition in accordance with the actual machining environment.
4. Please reduce the feed rate when the depth of cut is greater than specified.
5. Please adjust the cutting condition when the overhang length is longer.
6. Please use a suitable fluid with high smoke retardant properties.
7. During dry (no fluid) milling, please use air blow to remove disposable chips from the milling area and to eliminate chip packing.
8. Please use water-soluble coolant when machining stainless steel, cobalt-chromium alloy, titanium alloy, and Ni-based alloy.
9. Tool runout should be kept to a minimum for maximum accuracy.
10. When the cutting load fluctuates in areas such as the corners, please reduce the rotational speed.
11. If the pick amount is $0.5 \times D$ or more, cusp may occur on the machined surface.

PXHF-AM + PXMC 正面切削 Frontal Milling $5 < L/D \leq 6$

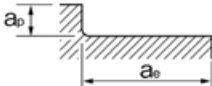
被削材 Work Material	調質鋼・プリハードン鋼 Hardened Steel· Prehardened Steel		調質鋼 Hardened Steel				ステンレス鋼 Stainless Steel		コバルトクロム基 Cobalt-Chromium Based Alloy (Stellite)		チタン合金 Titanium Alloy		Ni 基合金 Ni-Based Alloy (Inconel 718)	
	~45HRC		~62HRC		~70HRC		≤200HB							
切削速度 Cutting Speed (m/min)	90~110		70~90		50~70		100~120		90~110		70~90		20~40	
外径 DC	回転速度 Speed (min ⁻¹)	送り速度 Feed (mm/min)	回転速度 Speed (min ⁻¹)	送り速度 Feed (mm/min)	回転速度 Speed (min ⁻¹)	送り速度 Feed (mm/min)	回転速度 Speed (min ⁻¹)	送り速度 Feed (mm/min)	回転速度 Speed (min ⁻¹)	送り速度 Feed (mm/min)	回転速度 Speed (min ⁻¹)	送り速度 Feed (mm/min)	回転速度 Speed (min ⁻¹)	送り速度 Feed (mm/min)
12	2,650	2,670	2,120	2,140	1,590	800	2,920	2,940	2,650	2,670	2,120	2,140	800	350
16	1,990	2,670	1,590	2,140	1,190	800	2,190	2,940	1,990	2,670	1,590	2,140	600	350
20	1,590	2,670	1,270	2,130	960	810	1,750	2,940	1,590	2,670	1,270	2,130	480	350
切込深さ Depth of Cut	 <p>$a_p = \text{Max} : 0.02D$ $a_e = \text{Max} : 0.5D$</p>													

1. 本工具はアディティブ・マニュファクチャリング(金属積層)、金型肉盛り部表層の荒取り加工に使用することを推奨します。
2. 機械・ホルダは剛性のある精度の高いものをご使用下さい。
3. 上表の値はあくまでも目安です。実際の加工における切削条件は上表を参考に状況に応じて設定下さい。
4. 推奨条件よりも切込み量を大きくとる場合は、送り速度を抑えてご使用下さい。
5. 突出し長さが長くなる場合は、びびりが発生しやすくなりますので、回転速度、送り速度、切込み深さを調整下さい。
6. 切削油剤は被削材に適したもので、発煙性の少ないものをご使用下さい。
7. 乾式の場合には、切りくず詰まりが無いようエアブローにて切りくずを除去下さい。
8. ステンレス鋼、コバルトクロム合金、チタン合金、Ni 基合金の加工には、水溶性切削油剤の使用を推奨します。
9. 工具の振れ精度を最小限に抑えてご使用下さい。
10. コーナ部等切削負荷が変動する場合は、回転速度を抑えてご使用下さい。
11. ピック量が0.5D以上の場合、加工面にカスプが発生することがあります。

1. This tool is recommended for the roughing of additive manufacturing and mold overlay surfaces.
2. Please use machines and holders that are rigid and highly accurate.
3. The values listed above are for reference. Please set the cutting condition in accordance with the actual machining environment.
4. Please reduce the feed rate when the depth of cut is greater than specified.
5. Please adjust the cutting condition when the overhang length is longer.
6. Please use a suitable fluid with high smoke retardant properties.
7. During dry (no fluid) milling, please use air blow to remove disposable chips from the milling area and to eliminate chip packing.
8. Please use water-soluble coolant when machining stainless steel, cobalt-chromium alloy, titanium alloy, and Ni-based alloy.
9. Tool runout should be kept to a minimum for maximum accuracy.
10. When the cutting load fluctuates in areas such as the corners, please reduce the rotational speed.
11. If the pick amount is $0.5 \times D$ or more, cusp may occur on the machined surface.

Phoenix PXMC

ラジラス形状

Radius Type

PXHF-AM+PXMC

Cutting Conditions

■切削条件基準表 Cutting Conditions

加工に際しては、それぞれ擬似Rのラジラスエンドミルとして加工プログラムを作成下さい。

During machining, please program the milling paths according to the recommended simulated R (rt) respective to the individual end mill diameter.

PXHF-AM + PXMC 側面切削 Side Milling

被削材 Work Material	調質鋼・プリハードン鋼 Hardened Steel・ Prehardened Steel		調質鋼 Hardened Steel				ステンレス鋼 Stainless Steel		コバルトクロム基 Cobalt-Chromium Based Alloy (Stellite)		チタン合金 Titanium Alloy		Ni基合金 Ni-Based Alloy (Inconel 718)	
	~45HRC		~62HRC		~70HRC		≤200HB							
切削速度 Cutting Speed (m/min)	80~100		50~70		50~70		100~120		90~110		70~90		30~50	
外径 DC	回転速度 Speed (min ⁻¹)	送り速度 Feed (mm/min)	回転速度 Speed (min ⁻¹)	送り速度 Feed (mm/min)	回転速度 Speed (min ⁻¹)	送り速度 Feed (mm/min)	回転速度 Speed (min ⁻¹)	送り速度 Feed (mm/min)	回転速度 Speed (min ⁻¹)	送り速度 Feed (mm/min)	回転速度 Speed (min ⁻¹)	送り速度 Feed (mm/min)	回転速度 Speed (min ⁻¹)	送り速度 Feed (mm/min)
12	2,390	1,200	1,590	570	1,060	230	2,650	1,340	2,390	1,200	1,590	570	800	230
16	1,790	1,200	1,190	570	800	230	1,990	1,340	1,790	1,200	1,190	570	600	230
20	1,430	1,200	960	580	640	230	1,590	1,340	1,430	1,200	960	580	480	230
切込深さ Depth of Cut	ap=Max : 0.5D ae=Max : 0.05D		ap=Max : 0.5D ae=Max : 0.02D				ap=Max : 0.5D ae=Max : 0.05D				ap=Max : 0.5D ae=Max : 0.02D			

1. 本工具はアディティブ・マニファクチャリング(金属積層)、金型肉盛り部表層の荒取り加工に使用することを推奨します。
2. 機械、ホルダは剛性のある精度の高いものをご使用下さい。
3. 上表の値はあくまでも目安です。実際の加工における切削条件は上表を参考に状況に応じて設定下さい。
4. 推奨条件よりも切込み量を大きくとる場合は、送り速度を抑えてご使用下さい。
5. 上表は、工具の突出し量が4D以下の場合の目安です。突出し量が多い場合は、びびりが発生しやすくなりますので、回転速度、送り速度、切込み深さを調整下さい。
6. 切削油剤は被削材に適したもので、発煙性の少ないものをご使用下さい。
7. 乾式の場合には、切りくず詰まりが無いようエアブローにて切りくずを除去下さい。
8. ステンレス鋼、コバルトクロム合金、チタン合金、Ni基合金の加工には、水溶性切削油剤の使用を推奨します。
9. 工具の振れ精度を最小限に抑えてご使用下さい。
10. コーナ部等切削負荷が変動する場合は、回転速度を抑えてご使用下さい。

1. This tool is recommended for the roughing of additive manufacturing and mold overlay surfaces.
2. Please use machines and holders that are rigid and highly accurate.
3. The values listed above are for reference. Please set the cutting condition in accordance with the actual machining environment.
4. Please reduce the feed rate when the depth of cut is greater than specified.
5. The above table is a guide when the amount of protrusion of the tool is 4 x D or less. If the amount of protrusion is large, chattering is likely to occur, so adjust the rotation speed, feed rate and depth of cut.
6. Please use a suitable fluid with high smoke retardant properties.
7. During dry (no fluid) milling, please use air blow to remove disposable chips from the milling area and to eliminate chip packing.
8. Please use water-soluble coolant when machining stainless steel, cobalt-chromium alloy, titanium alloy, and Ni-based alloy.
9. Tool runout should be kept to a minimum for maximum accuracy.
10. When the cutting load fluctuates in areas such as the corners, please reduce the rotational speed.

Cutting Data

加工データ Cutting Data

工具剛性比較(突出し長さ違い) Tool Rigidity Comparison (by overhang length)

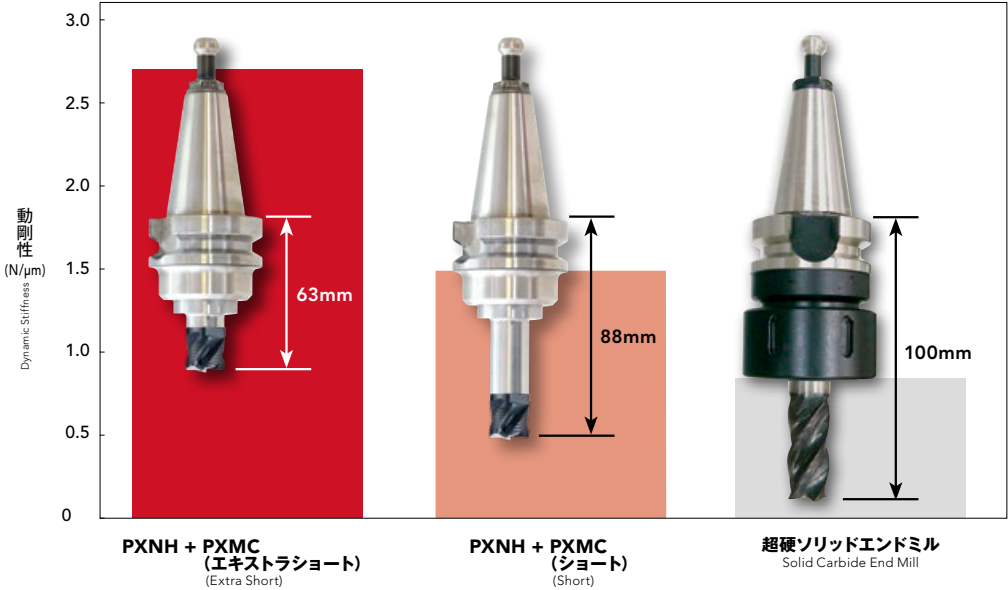

■ PXMC コレット Collet
・エキストラショートタイプ
Extra Short Type



・ショートタイプ
Short Type



■ PXM ヘッド Head
・PXNH



超硬ソリッドエンドミルに比べ、PXMCショートタイプは約1.5倍、エキストラショートタイプは約3倍の動剛性を持つため、びびりが軽減でき、広い切削領域を実現できる。動剛性とは、動的な力または動的なモーメントと、それによる動的な変位・変形との関係で表される剛性のことで、切削においては動剛性が大きいほうが安定した加工が可能である。

In comparison to the solid carbide end mill, the PXMC short type holder demonstrated 1.5 times the dynamic rigidity, while the extra short type holder demonstrated 3 times the dynamic rigidity. Both had exhibited minimal vibration, making them applicable to accommodate a wide machining range. Chatter vibration is commonly caused by the lack of sufficient dynamic rigidity to stabilize parts in a dynamic cutting force. Vibration can change as the result of a change in force, a change in rigidity, or both. The greater the dynamic rigidity the more machining stability can be achieved.

ツーリング別加工領域の違い Applicable Cutting Range Difference by Tooling Holders

溝加工 Slot Milling

使用工具 Tool	ヘッド Head	PXNH160C16-04C006	PXNH160C16-04C006	超硬ソリッドエンドミル Solid Carbide End Mill
	コレット Collet	PXMC-C1605 (エキストラショート) Extra Short	PXMC-C1630 (ショート) Short	標準コレット General Collet
サイズ Size		φ16 4刃 flutes		
被削材 Work Material		S50C		
切削方法 Cutting Method		溝加工 Slot Milling		
切込深さ Depth of Cut		ap=8mm (0.5D)		
切削油剤 Coolant		なし(エアブロー) Air Blow		
使用機械 Machine		立形マシニングセンタ(BT30) Vertical Machining Center		

負荷が大きい溝加工では、突出しの短いタイプで高能率加工が可能となる。エキストラショートタイプの能率は超硬ソリッドエンドミルに比べ**321%**という結果が得られた。

Short overhang length is ideal in order to achieve high-efficiency in heavy-duty operations such as slot milling. The extra short type holder was able to demonstrate 321% the efficiency versus a solid end mill tool.

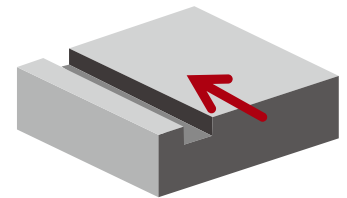

溝加工切削領域 Applicable Cutting Range of Slot Milling

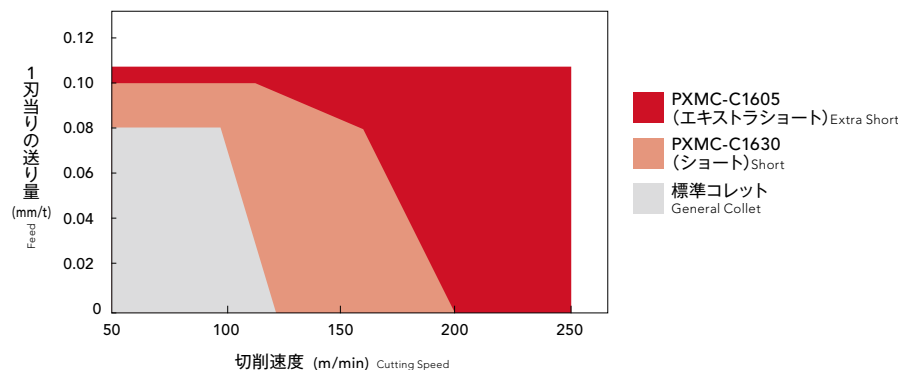

Cutting Data

加工データ Cutting Data

側面加工 Side Milling

使用工具 Tool	ヘッド Head	PXNH160C16-04C006	PXNH160C16-04C006	超硬ソリッドエンドミル Solid Carbide End Mill
	コレット Collet	PXMC-C1605 (エキストラショート) Extra Short	PXMC-C1630 (ショート) Short	標準コレット General Collet
サイズ Size	φ16 4刃 flutes			
被削材 Work Material	S50C			
切削方法 Cutting Method	側面加工 Side Milling			
切込深さ Depth of Cut	ap=10mm (0.63D) ae=6.4mm (0.4D)			
切削油剤 Coolant	なし(エアブロー) Air Blow			
使用機械 Machine	立形マシニングセンタ(BT30) Vertical Machining Center			

切りくず排出性が良く、エキストラショート・ショートタイプ共に安定した加工が可能となったが、より突出しの短いエキストラショートタイプの方が、高条件での加工に最適だった。

Although both of the extra short and short type holders were able to achieve good chip evacuation, the extra short holder, which has the shortest overhang length, is the most ideal for high efficiency machining.

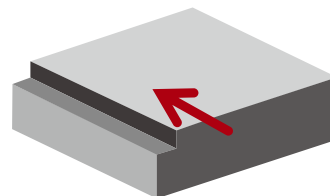

側面加工切削領域 Applicable Cutting Range of Side Milling

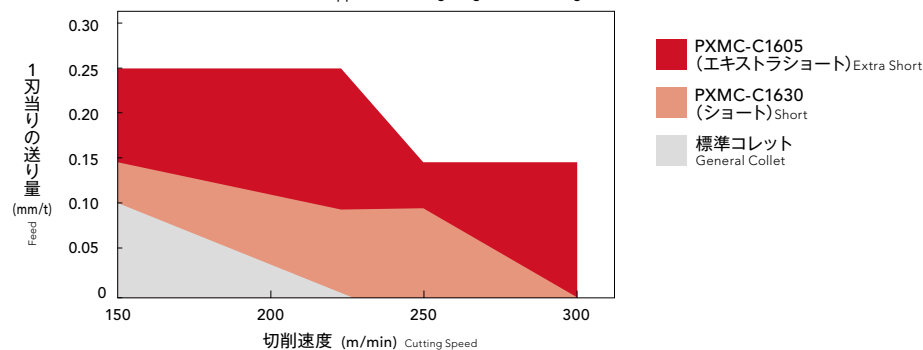

形状加工 Profile Milling

使用工具 Tool	ヘッド Head	PXNH160C16-04C006	PXNH160C16-04C006	超硬ソリッドエンドミル Solid Carbide End Mill
	コレット Collet	PXMC-C1605 (エキストラショート) Extra Short	PXMC-C1630 (ショート) Short	標準コレット General Collet
サイズ Size	φ16 4刃 flutes			
被削材 Work Material	S50C			
切削方法 Cutting Method	形状加工 Profile Milling			
切込深さ Depth of Cut	ap=8mm (0.5D) ae=4.8mm (0.3D)			
切削油剤 Coolant	なし(エアブロー) Air Blow			
使用機械 Machine	立形マシニングセンタ(BT30) Vertical Machining Center			

超硬ソリッドエンドミルでは加工負荷のかかるコーナ部で大きなびびり音が発生した。一方でPXMCエキストラショート・ショートタイプでは安定加工が可能だった。

For heavy-duty operations with significant load on the cutter corners, the solid carbide end mill exhibited chattering while both the PXMC extra short and short type holders were able to achieve stable performance.

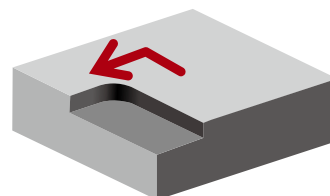

形状加工切削領域 Applicable Cutting Range of Profile Milling

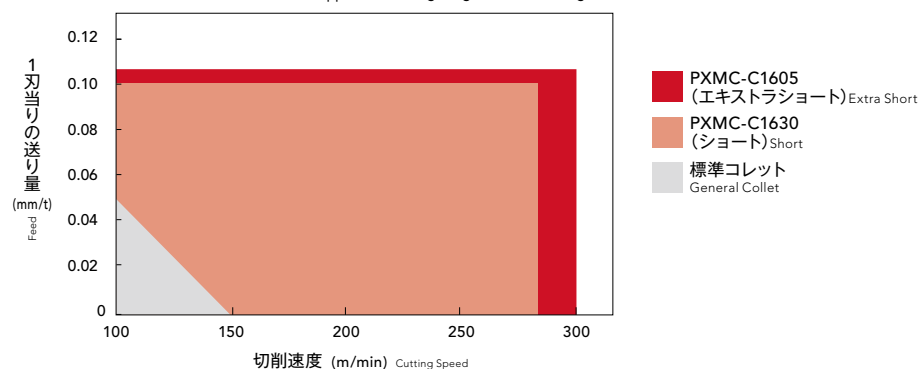

Performance Evaluation

性能評価 Performance Evaluation

現状 Problem

右図のようなワークを小型マシニングセンタで高能率に加工をする場合、

下記のような問題があった

- ・大径カッタ…切れ味と重量
- ・小径エンドミル…切込み量に限界
- ・ミドルサイズ…能率がいいが、コストは高い

To machine a work piece (such as figure shown on right) at high-efficiency settings on a small-size machining center, common problems include the following:

- ・ Large diameter cutter: inferior in terms of sharpness and weight
- ・ Small diameter cutter: Limited by output and efficiency
- ・ Mid-size cutter: Ideal efficiency but expensive

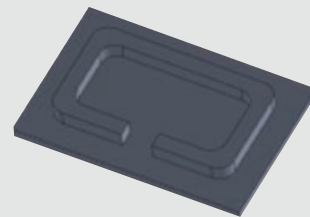

解決後 Solution

PXMCを使うことで軽量化に成功。突出し長さによるトラブルも解消し、今までにない加工能率を実現した。

The PXMC was able to resolve the problem by reducing the overhang length, tool weight, while achieving highly efficient performance.

工具種類別特長 Features by Diameter Size

《現状 Problem》

	小径エンドミル Small diameter cutter	ミドルサイズ Mid-size cutter	大径カッタ Large diameter cutter
コスト Cost	△	×	○
能率 Efficiency	×	○	△
安定加工 Stability	○	△	×
突出し Overhang Length	○	×	△
重量 Weight	○	△	×

《解決後 Solution》 ミドルサイズエンドミルをヘッド交換式+PXMCに変更した結果 By changing Solid mid-size end mill to exchangeable head end mill with PXMC collet

	小径エンドミル Small diameter cutter	PXMC	大径カッタ Large diameter cutter
コスト Cost	△	○	○
能率 Efficiency	×	◎	△
安定加工 Stability	○	○	×
突出し Overhang Length	○	○	△
重量 Weight	○	○	×

◎=とても良い ○=良い △=普通 ×=悪い
◎=Very Good ○=Good △=Fair ×=Bad

総切りくず排出量1,000cm³までの加工時間と損傷状態比較例 Machining time and tool wear comparison after total chip emission of 1,000cm³/min.

工具 Tool	小径超硬ソリッドエンドミル φ8 4枚刃 Solid Carbide End Mill φ8 4 flutes	PXNH160C16-04C006 φ16 4枚刃 flutes	インデキサブル工具 φ32 4枚刃 Indexable Tool φ32 4 flutes
使用工具 Tool	ホルダ Holder	コレットチャック Collet Chuck	PXMC-C1605
			ミーリングチャック Milling Chuck
ワーク 材質・サイズ Work: Material・Size	S50C (250×300×18mm)		
加工条件 Cutting Condition	側面切削での追込み加工 Thrust side milling n=1,800min ⁻¹ 、 Vf=5,370mm/min ap=9mm×2段、 ae=1.6mm Stages	側面切削での追込み加工 Thrust side milling n=5,970min ⁻¹ 、 Vf=4,770mm/min ap=9mm×2段、 ae=3.2mm Stages	等高線加工 Contour milling n=1,900min ⁻¹ 、 Vf=600mm/min ap=0.5mm×36段、 ae=16mm Stages
突出し長さ Overhang Length	95mm	63mm	150mm
切りくず排出量 M.R.R.	25.9cm ³ /min	173.3cm ³ /min	4.8cm ³ /min
加工時間 Time	38分37秒 38min. 37sec.	7分17秒 7min. 17sec.	208分20秒 208min. 20sec.
損傷 Damage	微小刃欠 Small Chipping	初期摩耗 Initial Wear	摩耗大 Large Wear
評価 Evaluation	△	◎	×

Technical Data

■ 技術資料 Technical Data

■ 取付け手順 Mounting Procedure

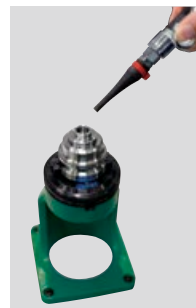
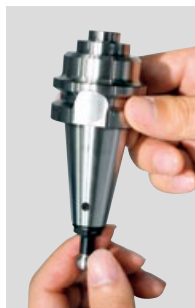

① 仮締め(BT30) Initial Tightening

コレットホルダの締結部分を清掃し、差し込む。
プルスタッドを回し、仮締めする。

※ BT30以外は下記をご参照下さい。

Make sure the fastening portion of the collet is clean then insert it into the holder. Turn the pull stud to tighten.

*For models other than BT30 please refer to the instructions below.

② 本締め Final Tightening

スパナで締める。

Tighten with a spanner wrench

③ 清掃 Cleaning

ヘッド、コレット締結部のゴミ、汚れを落とす。

Remove dirt and chips from the connecting thread and collet

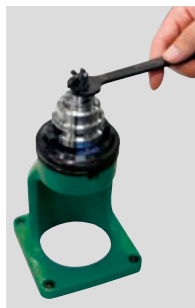
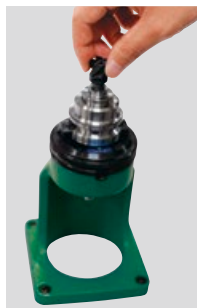

④ ヘッド装着 Mounting the Head

手締めをした後、PXM専用スパナで締める。

After screwing the head in by hand, use the PXM spanner wrench to tighten.

※ BT30以外の取付け手順 Mounting procedure for holders other than BT30

① 引きねじ六角部に六角レンチをしっかりと挿入する。

※穴付きプルスタッド(φ6以上)の場合、プルスタッドを付けたままで操作可能。

Insert the hexagon socket wrench into the pull screw hexagonal section.

*For pull studs with holes (φ6 or above), it is operational with the stud being attached.

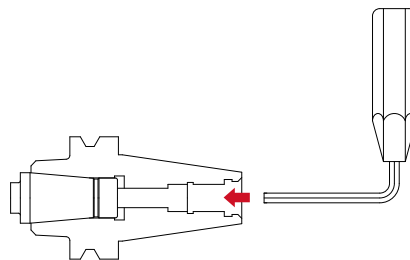

② コレットが回転しないよう、コレット先端部を手でサポートし、レンチを締付側(右回転)へ回転させ、所定のトルクで締め付ける。

※推奨締め付トルク：18N・m

To prevent the collet from rotating, support the tip of the collet by hand, tighten with the wrench by turning to the right, then fastening to the required torque.

*Recommended tightening torque: 18N・m

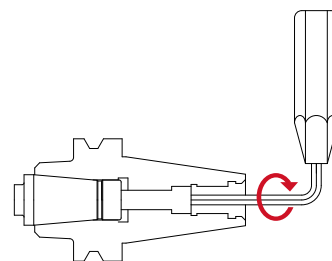

使用上の注意

Cautions during use

- ・ヘッド装着時はPXM専用スパナをご使用下さい(市販スパナはご使用できません)。
- ・推奨締め付トルクはp.267を参照下さい。
- ・ヘッドとコレットの端面が付くまで締め込んで下さい。隙間が無い事をご確認下さい。
- ・締結部を脱脂すると締め付けが固くなり、端面が付かなくなる可能性があります。脱脂はしないで下さい。
- ・スパナはヘッドの切欠きに合わせ挿入し、ゆっくりと回転させてご使用下さい。

・ Only use the spanner wrenches that are designed specifically for the PXM (p.267) for attaching PXM heads. Please do not use alternative spanner wrenches sold on the market as a replacement.

・ Please refer to p.267 for tightening torque.

・ Please tighten until the head and the collet faces meet. Confirm that there is no gap.

・ Degreasing the connecting thread may result in over tightening or a possible separation of the faces. Please do not degrease.

・ Please make sure that the spanner wrench is inserted properly and turn it slowly during use.

クランプねじ、推奨締め付けトルク Clamping Screw-Tightening Torque

ツールNo. EDP No.	ねじ呼び Designation	ねじサイズ Thread Size	トルクスサイズ Torx size	推奨締め付けトルク Recommended Tightening Torque	適用カッター(適用インサート) Applicable Cutters(Applicable Inserts)
7808098	FS18634P	M 1.8 × 3.4	06IP	0.5 N・m	PSE07... SS/SF φ10-12 (ZDKT07...)
7808096	FS18536P	M 1.8 × 3.6	06IP	0.7 N・m	PZAG04... SS φ14(ZPNT04...) PD φ12-14.5 (XCMT03...)
7808099	FS18637P	M 1.8 × 3.7	06IP	0.5 N・m	PMD07... φ16-18 (ZDKT07...) PSE07... SS φ16-26/SF φ16-32 (ZDKT07...)
7808100	FS18538	M 1.8 × 3.8	T06	0.7 N・m	PHP φ14-16 (SCMT04...)
7808102	FS20540	M 2 × 4	T06	0.7 N・m	PHP φ16.5-18 (SCMT05...)
7808139	FS20543P	M 2 × 4.3	06IP	0.7 N・m	PDZ φ16-18.5 (ZPNT05...) PD φ15-18.5 (XCMT04..., XCMT05...)
7808104	FS22550	M 2.2 × 5	T07	1.0 N・m	PHP φ18.5-20.5 (SCMT06...) PLDS...
7808138	FS22550P	M 2.2 × 5	07IP	1.0 N・m	PZAG06... SS φ17.5-23 (ZPNT06...) PDZ... φ19-22 (ZPNT06...) PD φ19-20.5 (XCMT06...)
7808105	FS25550	M 2.5 × 5	T08	1.6 N・m	PHC07... SS/SF φ16-35 (SPMT07...) PMD11... φ20-32 (ZDKT11...)
7808107	FS25656P	M 2.5 × 5.6	08IP	1.6 N・m	PSE11... SS/SF φ16-40 (ZD*T11...) PSEL11... SS φ25 (ZD*T11...)
7808108	FS25560	M 2.5 × 6	T08	1.6 N・m	PHP φ21-24 (SCMT07...) PDZ φ23-26 (ZPNT07...)
7808136	FS25560P	M 2.5 × 6	08IP	1.6 N・m	PD φ21-24.5 (XCMT07...) PSE11... BORE φ40-80 (ZD*T11...)
7808109	FS25673P	M 2.5 × 7.3	08IP	1.6 N・m	PSEL11... SS φ32-40 (ZD*T11...)
7808097	FS30668	M 3 × 6.8	T08	1.5 N・m	PSTW09... SS/BORE φ40-63 (TN*U09...) PZAG09... SS φ26-48 (ZPNT09...)
7808135	FS30570P	M 3 × 7	09IP	2.2 N・m	PDZ... φ27-34 (ZPNT08..., ZPNT09...) PMD07... φ16-18 (ZPNT08..., ZPNT09...) PD φ25-33.5 (XCMT08..., XCMT09...)
7808110	FS30573	M 3 × 7.3	T08	1.6 N・m	PHP φ24.5-28 (SCMT08...) PSF... PSFL09... SS/BORE φ32-50(SD*T09...)
7808116	FS30573A	M 3 × 7.3	T10	2.0 N・m	PRC10... SS/SF φ20-40 (RPH*10...)
7808111	FS35572	M 3.5 × 7.2	T15	3.2 N・m	PHP φ29-34 (SCMT10...) PHC09... SS/SF φ25-35 (SDMT09...)
7808112	FS35586	M 3.5 × 8.6	T15	3.2 N・m	PHC09... SS/SF φ40 / BORE φ40-63 (SDMT09...) PRC12... PRC SS/SF φ32-50 / BORE φ50-100 (RPH*12...)
7808137	FS35586P	M 3.5 × 8.6	15IP	3.2 N・m	PDZ... φ35-38 (ZPNT10...) PMD11R020... φ20 (ZPNT10...) PD φ34-44 (XCMT10..., XCMT12...)
7808115	FS35686P	M 3.5 × 8.6	15IP	3.2 N・m	PMD11... SS/SF φ20 (ZPNT10...) PSE15... SS/SF φ25-63 / BORE φ40-125 (ZD*T15...) PSEL15... SS φ40-50 / BORE φ50-80 (ZDKT15...)
7808129	FS40511	M 4.0 × 11	T15	5.0 N・m	PSTW BORE φ50-125 (TN*U12...) PSFL12... BORE φ63-100(SD*T12...)
7808113	FS45510	M 4.5 × 10.5	T20	5.0 N・m	PHP φ35-40 (SCMT12...) PHC12... SS/SF φ30-63 / BORE φ40-100 (SXMT12...) PRC16... PRC SS/SF φ32-63 / BORE φ50-100 (RPH*16...)
7808114	FS45510P	M 4.5 × 10	20IP	5.0 N・m	PMD11... φ25-32(ZPNT13..., ZPNT17...) PZAG13... BORE φ54-82(ZPNT13..., ZPNT17...) PDZ... φ39-43(ZPNT13...) PD φ45-63 (XCMT13..., XCMT14..., XCMT16...)
7808131	FS45513P	M 4.5 × 13	20IP	5.0 N・m	PAS...
7808130	FS50614	M 5 × 14	T20	5.0 N・m	PAO...
7808125	FS60620	M 6 × 17	T25	10.0 N・m	PFAL...

IP:トルクスプラス IP:Torx-Plus

Dimensions

■ 取付部寸法表 Dimensions

ボアタイプカッタ Bore Type Cutter

外径 DC	穴径 DCON	ボス径 DCSFMS	DAH	DCCB	取り付け 穴高さ CBDP	端面キー溝 Key Slot		カッタ 高さ LF	形状 Type	キャップスクリュー・ クランプボルト Clamping Screw	適用カッタ Applicable Cutters	推奨アーバ規格 Recommended Arbor Specification	
						幅 KWW	深さ b						
40	16	38	PS	PS	20	8.4	5.6	40	①	Power Screw	PSE11..., PSE15... PHC09..., PHC12...	FMC16	
			9	14	19					M8 × 30	PSTW09...		
50	16	40	9	15	20	8.4	5.6	55	②	M8 × 30	PFAL	FMC16	
			PS	PS	21					10.4	6.3		40
	22	45	11	17	21	8.4	5	50	②			M10 × 30	
										22.225	47	FMA22.225	
54	22	45	11	17	21	10.4	6.3	63	②	M10 × 30	PZAG13...	FMC22	
58	22	45	11	17	21	10.4	6.3	63	②	M10 × 30	PZAG13...	FMC22	
62	22	45	11	17	21	10.4	6.3	63	②	M10 × 30	PZAG13...	FMC22	
63	22	45	11	18	21	10.4	6.3	55	②	M10 × 30	PFAL	FMC22	
		50						PAS, PAO, PSF PSTW09..., PSTW12... PSE11..., PSE15... PRC12..., PRC16...					
								50			PHC09..., PHC12... PHC09..., PHC12...		
22.225	60	FMA22.225											
67	22	45	11	17	21	10.4	6.3	63	②	M10 × 30	PZAG13...	FMC22	
72	22	45	11	17	21	10.4	6.3	63	②	M10 × 30	PZAG13...	FMC22	
76	22	45	11	17	21	10.4	6.3	63	②	M10 × 30	PZAG17...	FMC22	
80	25.4	60	13.3	20.5	23	9.5	6	50	②	M12 × 40	PAS, PAO, PSF, PSTW12... PSE11..., PSE15... PRC12..., PRC16...	FMC25.4	
		70	-	40	28					③	MBA-M12		PFAL
	27	60	13	20	22	12.4	7	50	②	M12 × 40	PSE11..., PSE15..., PSTW12... PRC12..., PRC16...	FMC27	
		70	-	40	28					③	MBA-M12		PFAL
		76	13	20	22					②	M12 × 40		PHC12...
31.75	76	16.5	26	32	12.7	8	63	②	M16 × 40	PHC12...	FMA31.75		
82	22	45	11	17	21	10.4	6.3	63	②	M10 × 30	PZAG17...	FMC22	
100	25.4	80	-	40	28	9.5	6	50	③	MBA-M12	PFAL	FMC25.4	
	27										12.4		7
	31.75	70	44.45	32	12.7	8	50	③	MBA-M16	PAS, PAO, PSE15..., PSTW12... PRC12..., PRC16...	FMA31.75		
		80	55							PFAL			
		96	16.5							26		25	8
	32	70	18	27	26	14.4	8	50	②	M16 × 40	PHC12...	FMC32	
		96	17	27	26	14.4	8	63	③	MBA-M16	PFAL		
80		-	55	32	14.4	8.2	50	③	MBA-M16	PFAL			
125	25.4	80	-	40	28	9.5	6	50	③	MBA-M12	PFAL	FMC25.4	
	27										12.4		7
	38.1	60	36	38	15.9	10	63	③	MBA-M20	PFAL	FMA38.1		
		90	53.85							PAS, PAO, PSE15..., PSTW12...			
	40	80	60	30	28	16.4	9.2	63	②	MBA-M20	PFAL	FMB40	
90		56	28	9							PSTW12...		
160	25.4	80	-	40	28	9.5	6	50	③	MBA-M12	PFAL	FMC25.4	
	27										12.4		7
	40	85	-	60	30	16.4	9.2	63	③	MBA-M20	PFAL	FMB40	
				70	38	19.1	11						
50.8	100	-	74.42	38	19	11	63	③	MBA-M24	PFAL	FMA50.8		
			PAO										
200	47.625	150	-	-	38	25.4	14	63	④	M16 × 40 (4本)	PAO	FMA47.625	

ラフィングエンドミルボアタイプ Roughing End Mill Bore Type

外径 DC	穴径 DCON	ボス径 DCSFMS	DAH	DCCB	取り付け 穴高さ CBDP	端面キー 溝幅 KWW	端面キー 溝深さ b	カッタ 高さ LF	形状 Type	キャップスクリュー・ クランプボルト Clamping Screw	適用カッタ Applicable Cutters	推奨アーバ規格 Recommended Arbor Specification
50	22	45	11	18.4	21	10.4	6.3	74	⑤	M10 × 25	PSEL15...	FMC22
				17				75				
	27	48.5	13	18.5	23	12.4	7.0	75		M12 × 30	PSFL09...	FMC27
				100								
63	27	60	13	21.8	23	12.4	7.0	74	⑤	M12 × 30	PSEL15...	FMC27
		60.5						85				
		125										
80	32	76	18	28	28	14.4	8.0	88	⑤	M16 × 70	PSEL15...	FMC32
		77.3		25				95				
		143										
100	32	97	18	25	28	16.4	9.0	153	⑤	M16 × 70	PSFL12...	FMC32

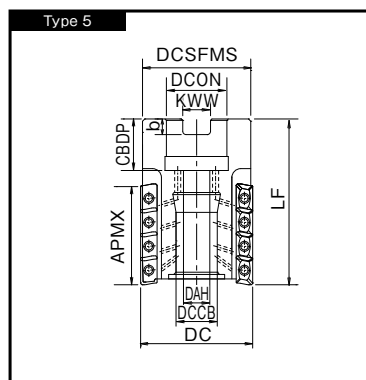
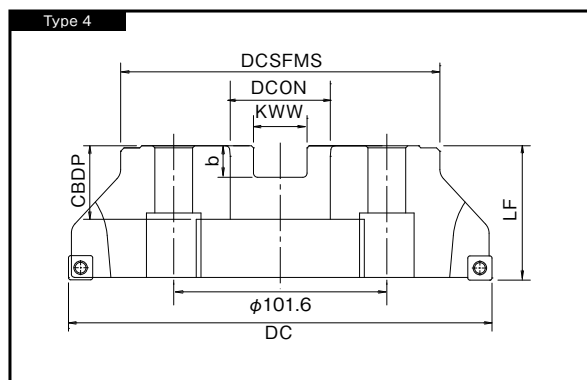
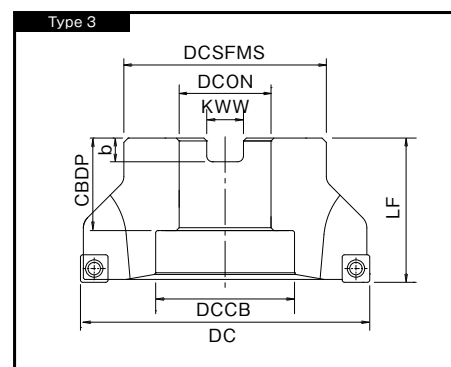
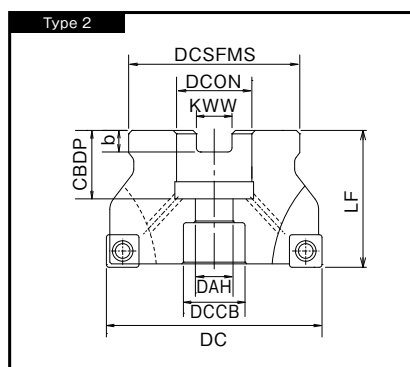
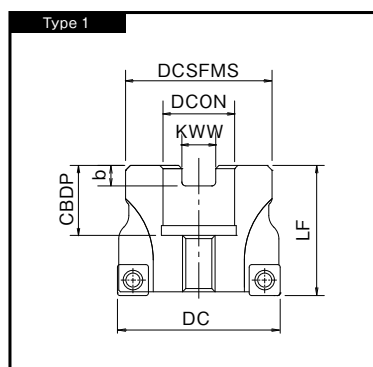

Insert · Cutter Body Selection Guide

インサート/ブレード呼びからボディを検索 Search by Alphabetical Order of Insert Designation

インサート 呼び Insert Designation	ボディ Body	掲載ページ Page
ADMT...	PDR SS, MT, CN, BORE	P.181 - P.188
FR1204, FR1206, FR1204-W	PFAL BORE	P.189 - P.198
OZKU...	PAO BORE	P. 87 - P. 92
PFB...	PFB SS, SF	P.199 - P.220
PFR...	PFR SS, SF	P.221 - P.236
RPHT..., RPHW..., RPMT...	PRC SS, BORE, SF	P.171 - P.180
SCMT...	PHP	P. 53 - P. 58
SDKT..., SDHT...	PSF SS, BORE	P. 93 - P. 96
	PSFL SS, BORE	P. 97 - P.102
SDMT..., SPMT..., SXMT...	PHC SS, BORE, SF	P.157 - P.170
SNKU...	PAS BORE	P. 83 - P. 86
TNHU..., TNKU...	PSTW SS, BORE	P.135 - P.144
TPKT...	PLDS SS, SF	P. 77 - P. 82
XAHT...	PAO BORE	P. 87 - P. 92
XCMT...	PD	P. 33 - P. 52
ZDHT...	PSE SS, BORE, SF	P.103 - P.124
	PSEL SS, BORE	P.125 - P.134
ZDKT...	PSE SS, BORE, SF	P.103 - P.124
	PSEL SS, BORE	P.125 - P.134
	PMD SS, SF	P.145 - P.156
ZPNT...	PDZ	P. 59 - P. 70
	PZAG SS, BORE	P. 71 - P. 76
	PMD SS, SF	P.145 - P.156

ボディからインサートを検索 Search by Listed Order

加工方法 Method	ボディ Body	インサート 呼び Insert Designation	掲載ページ Page
穴加工 Drilling	PD	XCMT...	P. 33 - P. 52
	PHP	SCMT...	P. 53 - P. 58
	PDZ	ZPNT...	P. 59 - P. 70
	PZAG SS, BORE	ZPNT...	P. 71 - P. 76
	PLDS SS, SF	TPKT...	P. 77 - P. 82
フライス加工 Milling	PAS BORE	SNKU...	P. 83 - P. 86
	PAO BORE	OZKU..., XAHT...	P. 87 - P. 92
	PSF SS, BORE	SDKT..., SDHT...	P. 93 - P. 96
	PSFL SS, BORE		P. 97 - P.102
	PSE SS, BORE, SF	ZDHT..., ZDKT...	P.103 - P.124
	PSEL SS, BORE		P.125 - P.134
	PSTW SS, BORE	TNHU..., TNKU...	P.135 - P.144
	PMD SS, SF	ZDKT..., ZPNT...	P.145 - P.156
	PHC SS, BORE, SF	SDMT..., SPMT..., SXMT...	P.157 - P.170
	PRC SS, BORE, SF	RPHT..., RPHW..., RPMT...	P.171 - P.180
	PDR SS, MT, CN, BORE	ADMT...	P.181 - P.188
	PFAL BORE	FR1204, FR1206, FR1204-W	P.189 - P.198
	PFB, SF	PFB...	P.199 - P.220
	PFR, SF	PFR...	P.221 - P.236

インデキサブルツール特殊品製作事例

Examples of Special Indexable Tools

加工に合わせた特殊品も承っております。
詳細は当社営業までお問い合わせ下さい。

Custom tooling are available upon request.
Please contact your local sales representative for details.



座ぐり刃付きPXDドリル
PXD Drill with Counterbore



面取り刃付きPXDドリル
PXD Drill with Chamfer



面取り刃付きPDドリル
PD Drill with Chamfer



座ぐり刃付きPDドリル
PD Drill with Counterbore



大径(DC>φ63)加工用PDドリル
PD Drill for Large Diameter Machining (DC > φ63)



**小型マシニングセンタ用
BT30一体型PDドリル**
BT30 Integrated PD Drill for Small Machining Centers



**ロングネック形
フラットドリルPDZ**
PDZ Long Neck Flat Drill



多段座ぐり用カッタ
Cutter for Multi-step Counterbore



裏座ぐり用カッタ
Cutter for Back Counterbore



**大径穴面取り用ドリル
PLDS**
PLDS Large Diameter Chamfering Cutter

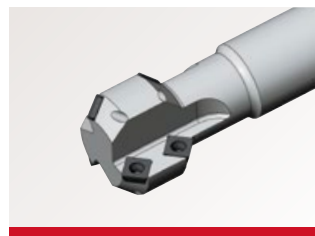

特殊面取り用カッタ
Cutter for Special Chamfering

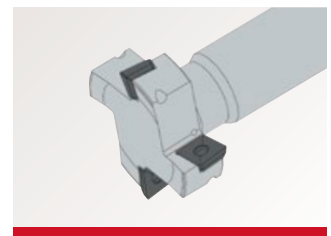

T-SLOTカッタ
T-slot Cutter



R溝用T-SLOTカッタ
T-slot Cutter for R Slotting

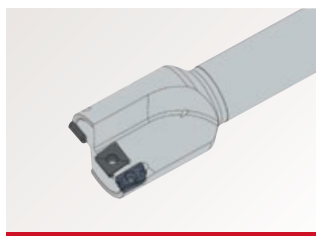

大径加工用多機能カッタPMD
PMD Multi-function Cutter for Large Diameter Machining



**ディスク型
正面フライスカッタ**
Face Milling Disc Cutter

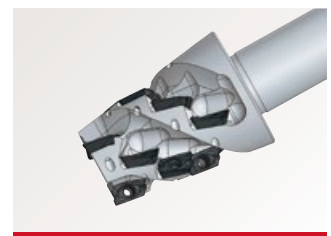

テーパラフィングカッタ
Taper Roughing Cutter



**BTシャンク一体型
ラフィングカッタ**
BT Shank Integrated Roughing Cutter



ダブテールカッタ
Dovetail Cutter



クリスマスカッタ
Christmas Cutter

MEMO

A large grid of graph paper, consisting of 20 columns and 30 rows of small squares, intended for taking notes or drawing.

MEMO

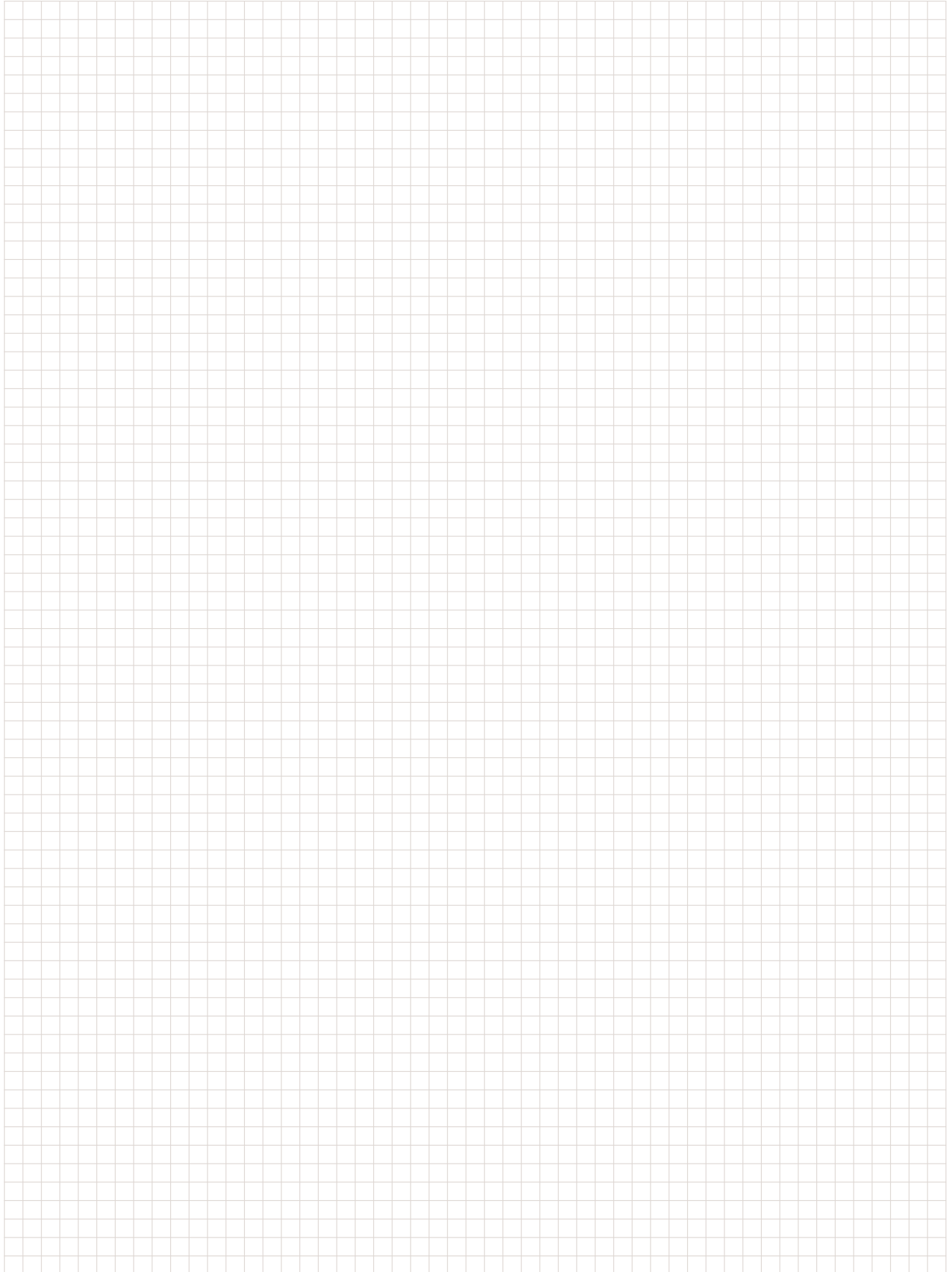

MEMO

A large grid of graph paper for taking notes, consisting of 20 columns and 30 rows of small squares.

MEMO

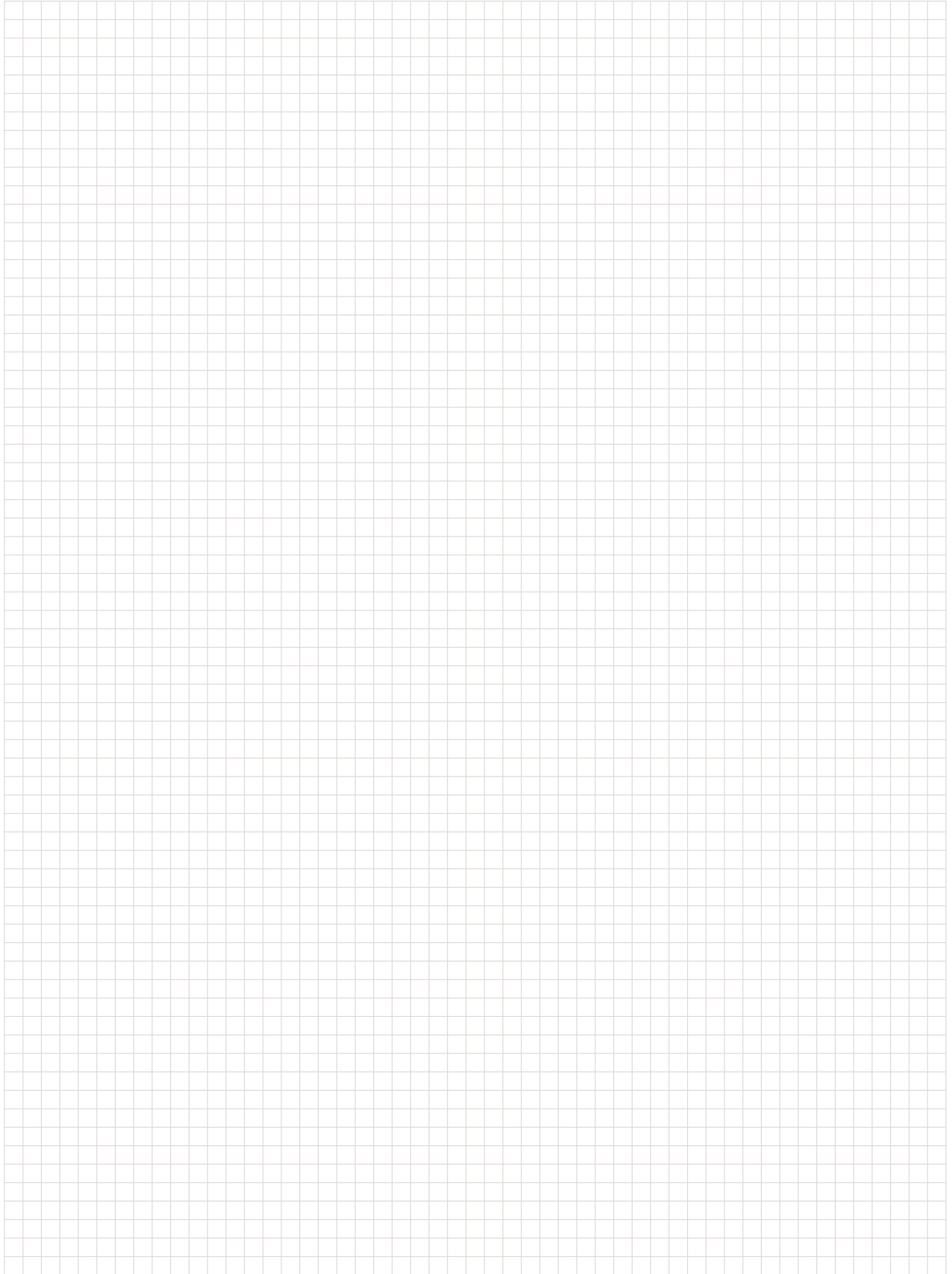

MEMO

A large grid of graph paper, consisting of 20 columns and 30 rows of small squares, intended for writing a memo.

オーエスジーは環境に優しい取り組みを推進しています

OSG's Environmental Initiatives

インデキサブル工具

Indexable Tools

インデキサブル工具は使用後の刃先（インサート）を交換することで繰り返し使用できる、環境に配慮した工具です。

Indexable tools are environmentally friendly tools that can be used repeatedly by replacing the cutting edge (insert) after use.

使用済インサートはリサイクル可能

Used inserts are recyclable

カッタボディは繰り返し使用可

Cutter body can be used repeatedly

希少金属のレアメタルを多く含む超硬材料の使用量を減らすことができ、環境保護に役立ちます

Contributes to environmental protection by reducing the use of carbide materials, which contain a large amount of rare metals.

超硬リサイクル

Carbide Recycling

再研磨できなくなった超硬工具は日本ハードメタルで「超硬リサイクル」することが可能です。

超硬リサイクルは、希少金属のレアメタルを多く含む超硬材料の使用量を減らすことができ、環境保護に役立ちます。

Carbide tools that can no longer be reground can be recycled through Nihon Hard Metal's carbide recycling program. Cemented carbide materials contain a large amount of rare metals. Carbide recycling reduces material consumption and contributes to environmental preservation.

日本ハードメタル「超硬リサイクル」の特長 Highlights of Nihon Hard Metal's "Carbide Recycling" Program

超硬工具であれば、エンドミル・ドリル・リーマ・チップ等の分別は不要

As long as the tool has been hardened, it doesn't have to be separated into categories such as end mills, drills, reamers, and tips.

多少の異材質工具が混入もOK

(サーメット、セラミック、または鋼材シャンク付きのものは選別)

Tools that contain a small amount of different materials are accepted (tools with cermet, ceramic and steel shanks are separated)

1回あたりの回収量：20kg～

(送料は日本ハードメタルにて負担・宅配便等着払い)

Amount of material that can be sent for recycling: 20kg and over (shipping costs are paid by Nihon Hard Metal Co., Ltd.)

リサイクル料金：振り込みにて対応

Recycling payment: by direct bank deposit





shaping your dreams

オーエスジー株式会社

〒442-8543 愛知県豊川市本野ケ原三丁目22番地
☎(0533)82-1111 FAX(0533)82-1131

東日本営業部

〒140-0002 東京都品川区東品川4-12-6
品川シーサイドキャナルタワー 19階 ☎(03)5715-2966 FAX(03)5460-2966

西日本営業部

〒550-0013 大阪府大阪市西区新町2-4-2 405号
☎(06)6538-3880 FAX(06)6538-3879

アプリケーション営業部

〒451-0051 愛知県名古屋市中区則武新町3-1-17
BIZrium名古屋 4階 ☎(052)589-8320 FAX(052)561-8310

仙台 ☎(022)390-9701	上田 ☎(0268)28-7381	明石 ☎(078)927-8212
郡山 ☎(024)991-7485	静岡 ☎(054)283-6651	金沢 ☎(076)268-0830
茨城 ☎(029)354-7017	浜松 ☎(053)461-1121	岡山 ☎(086)241-0411
向毛 ☎(0270)40-5855	豊川 ☎(0533)82-1145	広島 ☎(082)532-6808
宇都宮 ☎(028)651-2720	三河 ☎(0566)62-8286	四国 ☎(087)868-4003
新潟 ☎(025)288-3888	トヨタ ☎(0533)82-1145	九州 ☎(092)504-1211
東京 ☎(03)5715-2966	名古屋 ☎(052)589-8320	北九州 ☎(093)922-8190
八王子 ☎(042)645-5406	岐阜 ☎(058)259-6055	熊本 ☎(096)386-5120
厚木 ☎(046)230-5030	京滋 ☎(077)553-2012	
諏訪 ☎(0266)58-0152	大阪 ☎(06)4308-3411	

〈工具の技術的なご相談は…〉
コミュニケーションダイヤル

よい 工具は一番
0120-41-5981

土日祝日、会社休日を除く

コミュニケーションFAX **0533-82-1134** コミュニケーションE-mail **hp-info@osg.co.jp**

〈その他のお問い合わせは…〉 E-mail:**cs-info@osg.co.jp**

〈最新情報〉 OSG HP **https://www.osg.co.jp/**

OSG Corporation

3-22 Honnogahara, Toyokawa, Aichi, 442-8543, JAPAN
TEL. +81-533-82-1118 FAX. +81-533-82-1136

! 安全にお使いいただくために

- 工具を使用する時は、破損する危険があるので、必ずカバー・保護眼鏡・安全靴等を使用して下さい。
- 切れ刃は素手で触らないで下さい。
- 切りくずは素手で触らないで下さい。
- 工具の切れ味が悪くなったら使用を中止して下さい。
- 異常音・異常振動が発生したら、直ちに使用を中止して下さい。
- 工具には手を加えないで下さい。
- 加工前に工具の寸法確認を行って下さい。

! Safe use of cutting tools

- Use safety cover, safety glasses and safety shoes during operation.
- Do not touch cutting edges with bare hands.
- Do not touch cutting chips with bare hands. Chips will be hot after cutting.
- Stop cutting when the tool becomes dull.
- Stop cutting operation immediately if you hear any strange cutting sounds.
- Do not modify tools.
- Please use correct tools for the operation. Check dimensions to ensure proper selection.

◆ 製品については、常に研究・改良を行っておりますので、予告なく本カタログ掲載仕様を変更する場合があります。

◆ Tool specifications are subject to change without notice.

OSG代理店

※本書掲載内容の無断転載・複製を禁じます。 Copyright © 2017 OSG Corporation. All rights reserved.